

TM 5-2430-200-10

Operator's Manual

Deployable Universal Combat Earthmover (DEUCE)

30/30 (Model DV100)

NSN: 2430-01-423-2819

PIN: 7RR00003-Up

DISTRIBUTION STATEMENT A: Approved for public release; distribution is unlimited.

Headquarters, Department of the Army

MARCH 2001

**CHANGE
NO. 1**

**HEADQUARTERS, DEPARTMENT OF THE ARMY
WASHINGTON, DC, 18 MAY 2008**

**TECHNICAL MANUAL
OPERATOR'S MANUAL
FOR
DEPLOYABLE UNIVERSAL
COMBAT EARTHMOVER (DEUCE)
30/30 (MODEL DV100)
NSN 2430-01-423-2819
PIN: 7RR00003-UP**

DISTRIBUTION STATEMENT A - Approved for public release; distribution is unlimited.

TM 5-2430-200-10 dated 01 MARCH 2001 is updated as follows:

1. File this sheet in front of the manual for reference.
2. This change is a result of various configuration changes and updates to include: recoil alert system, sight gauge covers to rollers and rear idlers, changed and re-routed hydraulic hoses, updated PMCS, BII tools and NSNs.
3. A vertical bar in the outer margin of the page or between columns in a double column format indicates new or updated text or illustrations.
4. Remove old pages and insert new pages as indicated below.

REMOVE PAGE	INSERT PAGE	REMOVE PAGE	INSERT PAGE
1 through 4	A (B Blank)	A-21 through A-24	A-21 and A-21.00
7 through 10	1 through 4		A-21.01 and A- 22
13 and 14	7 through 10		A-23 and 24
17 through 22	13 and 14	B-1 and B-2	B-1 and B-2
27 and 28	17 through 22	C-1 through C-4	C-1 through C-4
31 and 32	27 and 28	D-1 and D-2	D-1 and D-2
35 through 42	31 and 32	E-1 through E-6	E-1 and E-1.00
45 and 46	35 through 42		E-1.01 Blank) and E-2
49 and 50	45 and 46		E-3 through E-6
53 through 62	49 and 50	DA 2028 Sample	DA 2028 Sample Front
65 through 88	53 through 62	None	DA 2028 Sample Back
97 and 98	65 through 88	None	DA 2028 Front and Back
103 through 106	97 and 98	Metric Chart	Metric Chart
109 through 118	103 through 106	PIN	PIN
121 through 132	109 through 118		
A-3 through A-6	121 through 132		
	A-3 and A-4		
	A-4.01 and A-4.02		
	(blank)		
	A-5 and A-6		
A-15 and A-16	A-15 and A-16		

By Order of the Secretary of the Army:

GEORGE W. CASEY, JR.
General, United States Army
Chief of Staff

Official:



JOYCE E. MORROW
Administrative Assistant to the
Secretary of the Army

0811910

DISTRIBUTION: To be distributed in accordance with the Initial Distribution Number (IDN) 256552, requirements for TM 5-2430-200-10.

INSERT LATEST CHANGED PAGES. DESTROY SUPERSEDED DATA.

LIST OF EFFECTIVE PAGES

NOTE: A vertical line in the outer margin of the page or between columns indicates the portion of the text or illustration affected by a change.

Dates of issue for original and changed pages are:

Original 0 01 March 2001

Change 1 18 May 2008

TOTAL NUMBER OF CHANGE PAGES IS 89 WHICH CONSISTS OF THE FOLLOWING:

* A zero in the Change Number columns below indicates an original page.

Page Number	*Change Number	Page Number	*Change Number
Cover.....	0	Page 77.....	0
A and B	1	Page 78 and 79	1
Page 1	1	Page 80.....	0
Page 2 and 3	0	Page 81 through 84	1
Page 4.....	1	Page 85.....	0
Page 5 and 6	0	Page 86	1
Page 7.....	1	Page 87.....	0
Page 8	0	Page 88.....	1
Page 9	1	Page 89 through 97	0
Page 10 through 12	0	Page 98.....	1
Page 13	1	Page 99 through 102	0
Page 14 through 17	0	Page 103 through 105	1
Page 18 through 22	1	Page 106 through 109	0
Page 23 through 26	0	Page 110 through 115	1
Page 27 and 28	1	Page 116.....	0
Page 29 through 31	0	Page 117	1
Page 32.....	1	Page 118 through 121	0
Page 33 and 34	0	Page 122 through 125	1
Page 35.....	1	Page 126.....	0
Page 36 and 37	0	Page 127 through 132	1
Page 38.....	1	Page A-1 through A-3	0
Page 39.....	0	Page A-4	1
Page 40 through 42	1	Page A-4.01 (A-4.02 blank)	1
Page 43 through 45	0	Page A-5	0
Page 46	1	Page A-6	1
Page 47 through 49	0	Page A-7 through A-14	0
Page 50.....	1	Page A-15 and A-16	1
Page 51 through 53	0	Page A-17 through A-20	0
Page 54 through 58	1	Page A-21	1
Page 59.....	0	Page A-21.00 and A-21.01	1
Page 60 and 61	1	Page A-22	0
Page 62 through 64	0	Page A-23 and A-24	1
Page 65 through 67	1	Page B-1	0
Page 68	0	Page B-2.....	1
Page 69 through 71	1	Page C-1.....	0
Page 72.....	0	Page C-2 through C-4.....	1
Page 73.....	1	Page D-1.....	0
Page 74 and 75	0		
Page 76.....	1		

TM5-2430-200-10
LIST OF EFFECTIVE PAGES

Page Number	*Change Number
Page D-2.....	1
Page E-1	1
Page E-1.00 (E-1.01 blank)	1
Page E-2.....	1
Page E-3.....	0
Page E-4.....	1
Page E-5.....	0
Page E-6.....	1
Page E-7 through F-2	0
Authorization Page.....	0
DA 2028 Sample Front & Back	1
DA 2028 Front & Back.....	1
Metric Chart.....	1
PIN.....	1

REPORTING ERRORS AND RECOMMENDING IMPROVEMENTS

You can help improve this publication. If you find any mistakes or if you know of a way to improve the procedures, please let us know. Submit your DA Form 2028 (Recommended Changes to Equipment Technical Publications), through the Internet, on the Army Electronic Product Support (AEPS) website. The Internet address is <http://aeeps.ria.army.mil>. The DA Form 2028 is located under the Public Applications section in the AEPS Public Home Page. Fill out the form and click on SUBMIT. Using this form on the AEPS will enable us to respond quicker to your comments and better manage the DA Form 2028 program. You may also mail, fax or email your letter, DA Form 2028 direct to: U. S. Army TACOM Life Cycle Management Command, ATTN: AMSTA-LC-LMPP/TECH PUBS, 1 Rock Island Arsenal, Rock Island, IL 61299-7630. The email address is ROCK-TACOM-TECH-PUBS@conus.ria.army.mil. The fax number is DSN 793-0726 or Commercial (309) 782-0726.

Table of Contents

Information Section

Foreword3

Safety Section

Important Safety Information4
 Safety5
 Warning Labels5
 General Hazard Information9
 Crushing or Cutting Prevention10
 Burn Prevention10
 Fire or Explosion Prevention11
 Threat of Nuclear, Biological, and Chemical (NBC) Contamination12
 ElectroMagnetic Pulse (EMP) Exposure12
 Mounting and Dismounting12
 Before Starting the Engine12
 Engine Starting12
 Before Operating the Machine13
 Machine Operation13
 Machine Parking13

General Section

Specifications and Model Views14
 Product Identification and Serial Number Locations15

Operation Section

Monitoring Systems and Cab Features17
 Machine Features38
 Equipment Controls50
 Before Starting the Engine52
 Engine Starting54

After Starting Engine60
 Machine Operation61
 Operating Techniques73
 Machine Parking76
 Transportation Information79
 Towing Information85
 Troubleshooting86

Maintenance Section

Cooling System Specifications99
 Fuel Specifications101
 Lubricant Specifications102
 Lubricant Viscosities and Refill Capacities103
 Lubrication Chart104
 Maintenance Intervals105
 When Required106
 Every 10 Service Hours or Daily112
 Every 50 Service Hours or Weekly125
 Every 250 Service Hours or 3 Months127

Index Section

Index129

Appendices

- A. Operator's Preventive Maintenance Checks and Services (OPMCS) – DEUCE**
- B. Components of End Item (COEI) – DEUCE**
- C. Basic Issue Items (BII) List—DEUCE**
- D. Additional Authorization List (AAL) – DEUCE**
- E. Unit Maintenance Level Transportation Information**
- F. PLGR Instructions**

Foreword

Literature Information

This manual should be stored in the operator's compartment. Store the manual in the pamphlet bag, which is provided as a Basic Issue Item (BII), or in the literature storage area on the back side of the operator's seat.

This manual contains safety, operation, transportation, lubrication, and maintenance information suitable for the Army operator.

Guards and covers may have been removed for illustrative purposes. Read, study and keep this manual with the machine.

Whenever a question arises regarding your machine, or this publication, please consult U.S. Army Tank-Automotive and Armaments Command (TACOM), your Caterpillar dealer, or Caterpillar Defense and Federal Products for the latest available information.

Safety

The Safety section lists basic safety precautions. In addition, this section identifies the text and locations of the warning signs and labels used on the machine.

Read and understand the basic precautions listed in the Safety section before operating or performing any lubrication, maintenance or repair on this machine.

Operation

The Operation information is a reference for the new operator and a refresher for the experienced one. This section includes a discussion of gauges, switches, machine controls, attachment controls, transportation, and towing information.

Photographs and illustrations guide the operator through the correct procedures for checking, starting, operating and stopping the machine.

Maintenance

The maintenance information is a guide to equipment care for Army operators. The illustrated, step-by-step instructions are grouped by servicing intervals. Items without specific intervals are listed under the When Required topics. Items in the Maintenance Intervals chart (refer to "Maintenance Section, Maintenance Intervals" in this manual) are referenced to detailed instructions that follow.

Maintenance Interval Schedule

Use the service hour meter to determine the servicing intervals. Calendar intervals shown (daily, weekly, monthly, etc.) can be used instead of the service hour meter intervals, if they provide more convenient servicing schedules and approximate the indicated service hour meter reading. Recommended service should always be performed at the interval that occurs first.

Under extremely severe, dusty or wet operating conditions, more frequent lubrication than is specified in the Maintenance Intervals chart might be necessary.

Perform service on items at multiples of the original requirement. For example, at Every 50 Service Hours or Weekly, also service those items listed under Every 10 Service Hours or Daily.

Machine Description



The Deployable Universal Combat Earthmover (DEUCE) is an earthmoving machine capable of travelling between sites at high speed. The DEUCE is equipped with a 3126 HEUI (Hydraulic Electronic Unit Injector) engine that operates at two power levels, 197 kW (265 hp) and 138 kW (185 hp). The machine is equipped with a power/angle/tilt (PAT) blade and a winch. The suspension on the machine can be activated for smooth operation at high speed, or locked, for a stable base when dozing.

California

Proposition 65 Warning

Diesel engine exhaust, and some of its constituents, are known to the state of California to cause cancer, birth defects, and other reproductive harm.

Important Safety Information

Most accidents involving product operation, maintenance and repair are caused by failure to observe basic safety rules or precautions. An accident can often be avoided by recognizing potentially hazardous situations before an accident occurs. A person must be alert to potential hazards. This person should also have the necessary training, skills and tools to perform these functions properly.

Improper operation, lubrication, maintenance or repair of this product can be dangerous and could result in injury or death.

Do not operate or perform any lubrication, maintenance or repair on this product, until you have read and understood the operation, lubrication, maintenance and repair information.

Safety precautions and warnings are provided in this manual and on the product. If these hazard warnings are not heeded, bodily injury or death could occur to you or other persons.

The hazards are identified by the “Safety Alert Symbol” and followed by a “Signal Word” such as “WARNING” as shown below.



The meaning of this safety alert symbol is as follows:

Attention! Become Alert! Your Safety is Involved.

The message that appears under the warning, explaining the hazard, can be either written or pictorially presented.

NOTICE

Operations that may cause product damage are identified by NOTICE labels on the product and in this publication.

Caterpillar cannot anticipate every possible circumstance that might involve a potential hazard. The warnings in this publication and on the product are therefore not all inclusive. If a tool, procedure, work method or operating technique not specifically recommended by Caterpillar is used, you must satisfy yourself that it is safe for you and others. You should also ensure that the product will not be damaged or made unsafe by the operation, lubrication, maintenance or repair procedures you choose.

The information, specifications, and illustrations in this publication are on the basis of information available at the time it was written. The specifications, torques, pressures, measurements, adjustments, illustrations, and other items can change at any time. These changes can affect the service given to the product. Obtain the complete and most current information before starting any job. TACOM and Caterpillar dealers will have the most current information available. For a list of the most current publication form numbers available, see the Caterpillar Service Manual Contents Microfiche, REG1139F.

Safety

Warning Labels

There are several specific warning labels on this machine. The exact location of each label and a description of the hazard are reviewed in this section. Please review the location and content of each warning label.

NOTE: The warning labels on the radiator and engine valve covers are not accessible to the operator

Make sure all warning labels can be read. Clean or have the warning labels replaced if the words cannot be read, or the illustrations are not clear. When cleaning the warning labels, use a cloth, water, and soap. Do not use solvent, gasoline, etc., to clean the warning labels. Solvents or gasoline, etc., could loosen the label adhesive and allow the sign to fall off.

If a warning label is attached to a part that is replaced, make sure a new label is installed on the replaced part. Contact TACOM or any Caterpillar dealer for new warning labels. Refer to the following group numbers in *Parts Manual, Deployable Universal Combat Earthmover (DEUCE)* for the part numbers of the warning labels and data plates:

- 1004943 Cover GP-Valve Mechanism
- 1228811 Paint GP-Transfer
- 1243842 Cylinder GP & Mounting (Front)
- 1243847 Cylinder GP & Mounting (Bogie)
- 1450425 Cab GP-Basic
- 1520463 Wiring GP & Battery (Optional Arctic)



Improper jumper cable connections can cause explosion, resulting in personal injury.

Batteries may be located in separate compartments. When using jumper cables, always connect positive (+) cable to positive (+) terminal of battery connected to starter solenoid and negative (-) cable from external source to starter negative (-) terminal. (If machine not equipped with starter negative terminal, connect to engine block.) Follow procedure in the operation manual.

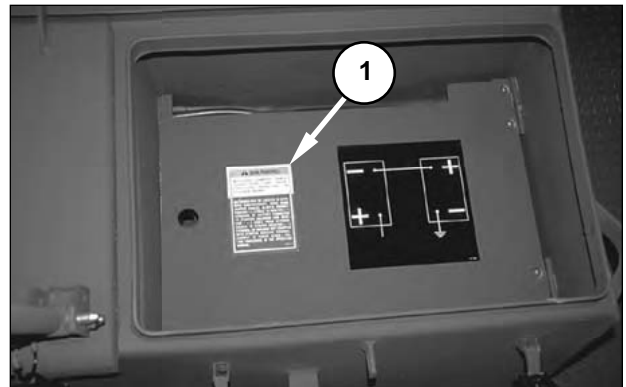

Warning label (1) is located inside the battery compartment, at the rear of the machine.

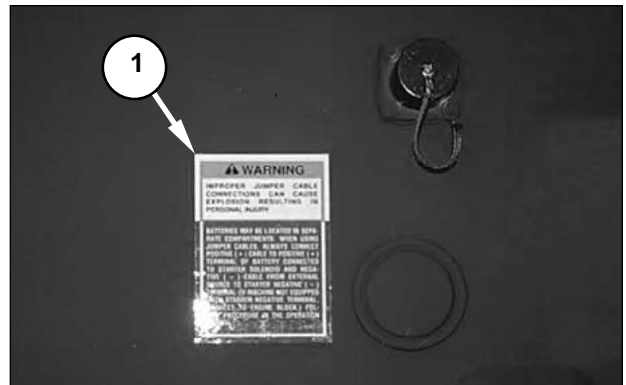

A second copy of warning label (1) is located on the left side of the machine, towards the rear, near the auxiliary start receptacle (NATO slave).



A third copy of warning label (1) is located on the arctic battery box, if the machine is equipped with the arctic battery option.

⚠ WARNING

Pressurized system: hot coolant can cause serious burn. To open cap, stop engine, wait until radiator is cool, then loosen cap slowly to relieve the pressure.

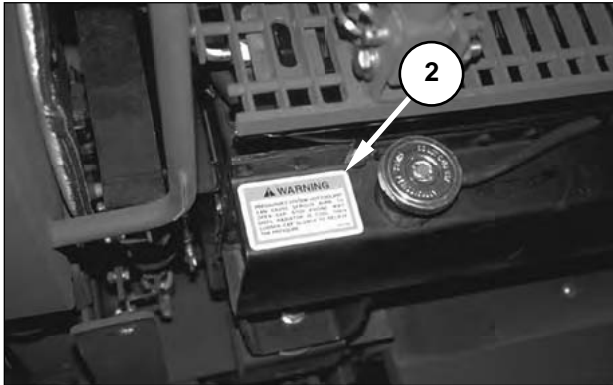

Warning label (2) is located on the radiator, near the cap.

⚠ WARNING

- If a load slips or falls—you can be injured or killed.
- Always be alert when around moving or overhead loads.
- Always keep hands and body away from block sheaves and swivels—and away from “pinch points” where rope touches block parts.
- Always inspect tackle block system and parts before each use.
- See OSHA Rule 1926 550(G) for personnel hoisting for cranes and derricks. Only a Crosby or McKissick Hook with a PL latch attached and secured with the bolt, nut and cotter pin provided, may be used. For any personnel hoisting, a hook with or without a Crosby Ss-4055 Latch attached shall not be used for personnel hoisting.
- Never use tackle block without proper instruction and training.
- Only use proper component parts.

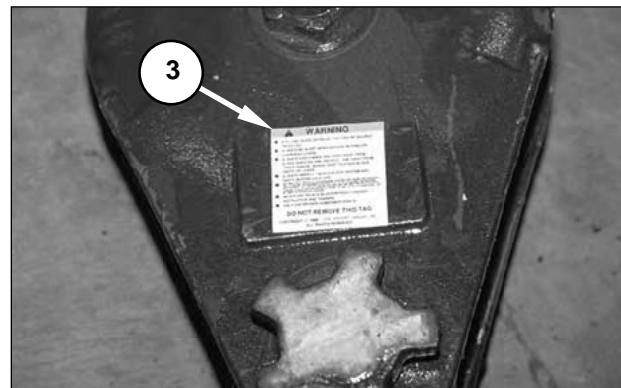

Warning label (3) is located on the winch doubling block.

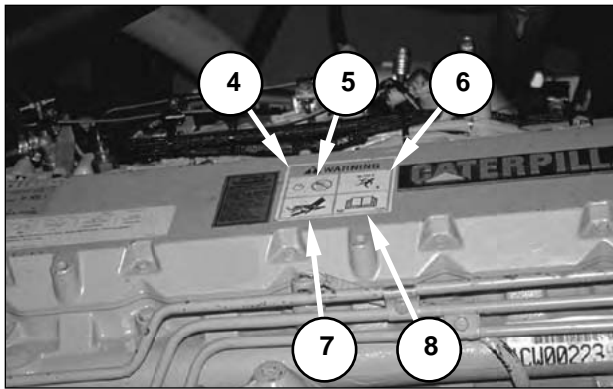

Warning label (4) is located on the engine valve cover. This warning label is a four-quadrant graphic label. Quadrant (5) warns against injecting ether into the air intake system. Quadrant (6) warns of an electrical shock hazard. Quadrant (7) warns that damaged high-pressure oil lines can cause injury. Quadrant (8) directs personnel to read the service manual before performing service on the engine.

! WARNING

The protection offered by this ROPS will be impaired if it has been subjected to any modification, structural damage, or has been involved in an overturn incident. This ROPS must be replaced after a roll-over. Seat belts must be worn while operating vehicle.



Warning label (9) is located on the top right corner of the cab, inside the operator's compartment.

NOTE: ROPS is the acronym for Rollover Protective Structure.

! WARNING

Do not operate or work on this machine unless you have read and understand the instructions and warnings in the operation and maintenance manuals. Failure to follow the instructions or heed the warnings could result in injury or death. Contact any Caterpillar dealer for replacement manuals. Proper care is your responsibility.



Warning label (10) is located on the console to the right of the operator's seat.

⚠ WARNING

If NBC exposure is suspected all air filter media will be handled by personnel wearing full NBC protective equipment. See operator maintenance manuals. Failure to comply could result in serious illness or death.

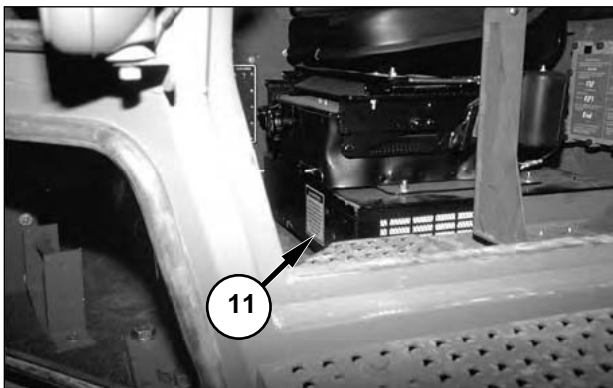
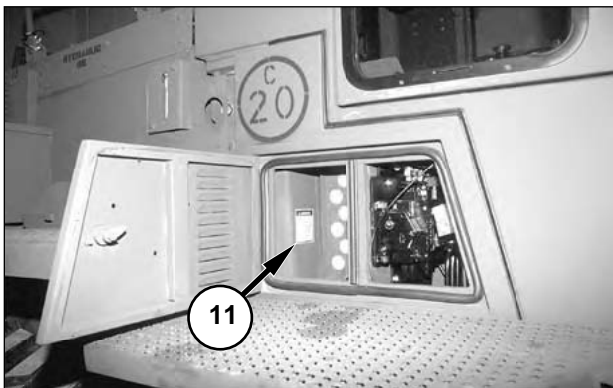
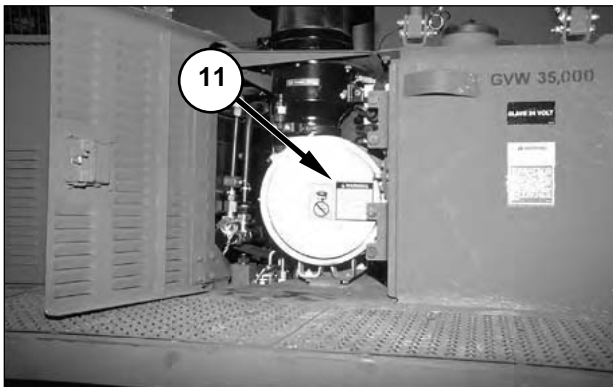

Warning label (11) is located at all air filter locations.

NOTE: NBC is an acronym for nuclear, biological, or chemical.

⚠ WARNING

High intensity noise. Hearing protection required within 33 feet when operating.



Warning label (12) is located on the left side of the machine, to the rear of the cab door.

! WARNING

Accumulator and connecting lines may be pressurized.

Read and follow the maintenance manual and the instructions below before working on the accumulator and connecting lines.

Failure to follow the maintenance manual or the instructions can cause rapid discharging of gas or hydraulic fluids which can result in injury or death.

1. Slowly bleed all hydraulic pressure off the hydraulic side of the accumulators by using the hydraulic disconnects.

2. Slowly discharge all gas pressure by opening gas valve at one end of the accumulator until gas begins to escape. Wait until all gas pressure is relieved before proceeding with next maintenance procedure.

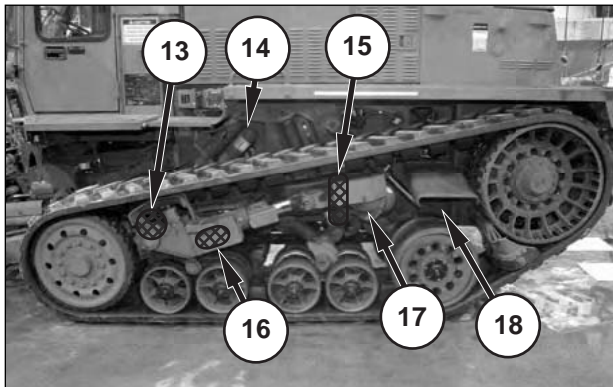

(13) Brake accumulator, beneath cab. (14) Front cylinder accumulator, each side of machine. (15) Middle cylinder accumulator, each side of machine. (16) Bogie cylinder accumulator, each side of machine. (17) Recoil accumulator, each side of machine. (18) Kneeling accumulator, each side of machine.

Accumulator warning labels are attached to each accumulator on the machine.

General Hazard Information

Attach a Do Not Operate warning tag to the start switch or controls before servicing or repairing the machine. This tag is available from TACOM.

Know the width of your attachments so that proper clearance can be maintained when operating near fences, boundary obstacles, etc.

Wear a hard hat, protective glasses, and other protective equipment as required by job conditions.

Wear eye and face protection when working with hydraulic or air lines.

Do not wear loose clothing or jewelry that can catch on the controls, or other parts of the machine.

Make certain that all protective guards and covers are secured in place on the machine.

Keep the machine, especially the deck, walkways and steps, free of foreign material; such as debris, oil, tools and other items which are not part of the machine.

Secure all loose items such as tools and other items which are not part of the machine.

Know the appropriate work site hand signals and who gives them. Accept signals from one person only.

Do not smoke when servicing air conditioners or wherever refrigerant gasses may be present. Inhaling air-conditioner refrigerant gas through a lit cigarette or other smoking method or inhaling fumes released from a flame contacting air-conditioner refrigerant gas can cause bodily harm or death.

Never put maintenance fluids into glass containers.

Drain all liquids into a suitable container. Dispose of all liquids according to local regulations.

Use all cleaning solutions with care.

Report all needed repairs.

Do not allow unauthorized personnel on the machine.

Do not operate the engine coolant heater while refueling the machine. Do not place any combustible or heat sensitive material within 50.8 mm (2 in) of the heater's exhaust system. Routinely inspect the fuel delivery system for leaks. Repair all leaks before operating the heater. Operation of the heater produces harmful vapors which represent an asphyxiation hazard. To guard against asphyxiation: do not operate the heater in an enclosed space; ensure that no exhaust fumes enter the operator's compartment. Exhaust components can be extremely hot. Do not touch the exhaust components until the parts are cool.

Performance of Maintenance

Unless otherwise specified, maintenance should be performed with the machine parked on level ground, the blade resting on the ground, the transmission control lever in NEUTRAL, the parking brake engaged, the engine stopped, and the electrical disconnect switch in the OFF position.

Pressure Air

Pressure air can cause personal injury. When using pressure air for cleaning, wear a protective face shield, protective clothing, and protective shoes.

The maximum air pressure must be below 205 kPa (30 psi) for cleaning purposes.

Fluid Penetration

Always use a board or cardboard when checking for a leak. Escaping fluid under pressure, even a pin-hole size leak, can penetrate body tissue, causing serious injury, and possible death. If fluid is injected into your skin, it must be treated immediately by a doctor familiar with this type of injury.

Crushing or Cutting Prevention

Support equipment and attachments properly when working beneath them. Do not depend on hydraulic cylinders to hold them up. Any attachment can fall if a control is moved, or if a hydraulic line breaks.

Never attempt adjustments while the machine is moving, or the engine is running, unless otherwise specified.

Where there are attachment linkages, the clearance in the linkage area will increase or decrease with movement of the attachment.

Stay clear of all rotating and moving parts.

Keep objects away from moving fan blades. They will throw or cut any object or tool that falls, or is pushed, into them.

Do not use a kinked or frayed wire rope cable. Wear gloves when handling the wire rope cable.

Retainer pins, when struck with force, can fly out and injure nearby persons. Make sure the area is clear of people when driving retainer pins.

Wear protective glasses when striking a retainer pin, to avoid injury to your eyes.

Chips, or other debris, can fly off objects when struck. Make sure no one can be injured by flying debris before striking any object.

Rollover Protective Structure (ROPS) or Falling Objects Protective Structure (FOPS)

ROPS or FOPS are guards located above the operator's compartment and secured to the machine.

To avoid any possible weakening of the ROPS or FOPS, consult TACOM or any Caterpillar dealer before altering, adding weight to, welding on, or cutting or drilling holes into the structure.

Any alteration not specifically authorized by Caterpillar invalidates Caterpillar's ROPS and FOPS certification. The protection offered by the ROPS/FOPS will be impaired if it has been subjected to structural damage. Structural damage can be caused by an overturn accident, by falling objects, etc.

Burn Prevention

Coolant

At operating temperature, the engine coolant is hot and under pressure. The radiator and all lines to heaters, or the engine, contain hot coolant or steam. Any contact can cause severe burns.

Steam can cause personal injury.

Check the coolant level only after the engine has been stopped and the fill cap is cool enough to remove with your bare hand.

Remove the cooling system fill cap slowly to relieve pressure.

Cooling system additive contains alkalis that can cause personal injury. Avoid contact with the skin, eyes, and mouth.

Allow cooling system components to cool before draining.

Oils

Hot oil and components can cause personal injury. Do not allow hot oil or components to contact the skin.

At operating temperature, the hydraulic tank is hot and can be under pressure.

Remove the hydraulic tank fill cap only after the engine has been stopped, and the fill cap is cool enough to remove with your bare hand.

Remove the hydraulic tank fill cap slowly, to relieve pressure.

Relieve all pressure in air, oil, fuel, or cooling systems before any lines, fittings or related items are disconnected or removed.

Batteries

Batteries give off flammable fumes which can explode.

Do not smoke when observing the battery electrolyte levels.

Electrolyte is an acid and can cause personal injury if it contacts the skin or eyes.

Always wear protective glasses when working with batteries.

Fire or Explosion Prevention

All fuels, most lubricants, and some coolant mixtures are flammable.

Fuel leaked, or spilled, onto hot surfaces or electrical components can cause a fire.

Do not smoke while refueling or while in a refueling area.

Do not smoke in areas where batteries are charged, or where flammable materials are stored.

Refer to "Operation Section, Engine Starting" in this manual for specific starting instructions.

Clean and tighten all electrical connections. Check daily for loose or frayed electrical wires. Have all loose or frayed electrical wires tightened, repaired, or replaced before operating the machine.

Keep all fuels and lubricants stored in properly marked containers and away from all unauthorized persons.

Store all oily rags, or other flammable material, in protective containers.

Do not weld or flame cut on pipes or tubes that contain flammable fluids. Clean them thoroughly with a nonflammable solvent before welding or flame cutting on them.

Remove all flammable materials such as fuel, oil and other debris before they accumulate on the machine.

Do not expose the machine to flames, burning brush, etc., if at all possible.

Shields, which protect hot exhaust components from oil or fuel spray in the event of a line, tube or seal failure, must be installed correctly.

Fire Extinguisher

Have a fire extinguisher available and know how to use it. Inspect and have it serviced as recommended on its instruction plate.

Make sure the fire extinguisher is mounted on the right side fender at the rear of the machine, in the location provided.

Ether

Ether is poisonous and flammable.

Inhaling ether vapors, or the repeated contact of ether with skin, can cause personal injury.

Use ether only in well-ventilated areas.

Do not smoke while changing ether cylinders.

Use ether with care to avoid fires.

Do not store replacement ether cylinders in living areas or in the operator's compartment.

Do not store ether cylinders in direct sunlight or at temperatures above 40°C (102°F).

Discard the cylinders in a protective place. Do not puncture or burn the cylinders.

Keep ether cylinders out of the reach of unauthorized personnel.

Lines, Tubes and Hoses

Do not bend or strike high pressure lines. Do not install bent or damaged lines, tubes or hoses.

Repair any loose or damaged fuel and oil lines, tubes and hoses. Leaks can cause fires.

Check all lines, tubes and hoses carefully. Do not use your bare hand to check for leaks. Use a board or cardboard to check for leaks. Refer to "Safety, Fluid Penetration" in this section for more details. Tighten all connections to the recommended torque. Replace if any of the following conditions are found:

- End fittings are damaged or leaking.
- Outer covering is chafed or cut, and the wire reinforcing is exposed.
- Outer covering is ballooning locally.
- There is evidence of kinking, or crushing, of the flexible part of the hose.
- Hose armor is embedded in the outer cover.
- End fittings are displaced.

Make sure that all clamps, guards and heat shields are installed correctly, to prevent vibration, rubbing against other parts, and excessive heat during operation.

Threat of Nuclear, Biological, and Chemical (NBC) Contamination

The DEUCE incorporates a CARC painted exterior. The materials used in the DEUCE are metal, rubber, plastic, fabric and glass. In the event of NBC contamination, the decontaminates for these surfaces and materials are listed in Army FM 3-5. For decontamination procedures, refer to Army FM 3-7. The DEUCE Parts Manual, TM5-2430-200-24P, contains a list of parts that are susceptible to damage from NBC exposure.

ElectroMagnetic Pulse (EMP) Exposure

The components listed and designated as EMP susceptible may be damaged by EMP exposure. If the machine is exposed to an EMP incident, verify proper operation and repair as necessary. The DEUCE Parts Manual, TM5-2430-200-24P, contains a list of parts that are susceptible to damage from EMP exposure.

Mounting and Dismounting

This machine can be mounted or dismounted at the left front of the machine.

- Mount and dismount the machine only on the left side, where steps and hand holds are provided.

- Inspect, and when necessary, clean and have repairs made to the steps and hand holds before mounting and dismounting.
- Face the machine when mounting and dismounting.
- Maintain a three-point contact (two feet and one hand or one foot and two hands) with the steps and hand holds.
- Never get on or off a moving machine.
- Never jump off the machine.
- Do not try to climb on or off the machine when carrying any tools or supplies. Use a hand line to pull any equipment up onto the platform.
- Do not use any controls as hand holds when entering or leaving the operator's station.
- Always raise and then use the handrail when on the walkways.
- Keep the walkways free of debris and oil. Clean away any ice or snow that has accumulated.

Alternate Exit

This machine is equipped with an alternate exit. For additional alternate exit information, refer to "Operation Section, Monitoring Systems and Cab Features" in this manual.

Before Starting the Engine

Start the engine only from the operator's station. Never short across the starter terminals or across the batteries, as this could bypass the engine neutral-start system, as well as damage the electrical system.

Before starting the engine, refer to "Operation Section, Before Starting the Engine" in this manual.

Engine Starting

Do not start the engine or move any of the controls if there is a Do Not Operate or similar warning tag attached to the start switch or controls.

Diesel engine exhaust contains products of combustion which can be harmful to your health. Always start and operate the engine in a well-ventilated area. If the machine is in an enclosed area, vent the exhaust to the outside.

This machine will spot turn with the engine running, even though the transmission control is in NEUTRAL. Always apply the parking brake while starting the engine.

To start the engine, refer to the procedures given in “Operation Section, Engine Starting” in this manual.

Before Operating the Machine

Clear all personnel from the machine and the area.

Clear all obstacles from the path of the machine. Beware of hazards such as wires, ditches, etc.

If radio antennas are installed, ensure that none of the antennas will contact electrical wires when the machine is operated. If clearance is not sufficient, tie the antennas down to avoid contact with electrical wires.

Be sure all windows are clean. Secure the doors and windows in either the open or shut position.

Adjust the rear view mirrors for best vision, especially close to the machine.

Make sure the machine horn, the back-up alarm and all other warning devices are working properly.

Adjust the tilt and length of the steering column so that it is best suited for operating the machine.

Fasten the seat belt securely.

Before operating this machine, read and understand the information given in the “Operation Section” of this manual.

Machine Operation

Operate the machine only while seated and with the seat belt fastened.

To minimize whole body vibration, based on 24 hour operations, limit daily machine usage to a maximum of 11.5 hours, no more than 4 hours continuous; the operator must rest between operations at least 4.16 hours.

Operate the controls only with the engine running, unless instructed otherwise.

The operator must be satisfied that no one will be endangered before moving the machine.

Do not allow riders on the machine.

Report any needed repairs noted during operation.

Stay a safe distance from the edge of cliffs, overhangs and slide areas.

If the machine begins to side slip on a grade, immediately turn the machine downhill.

Be careful to avoid any condition which could lead to tipping when working on hills, banks or slopes, and when crossing ditches, ridges or other obstructions. Whenever possible, work up and down slopes, rather than sideways.

Keep the machine under control and do not work it over its capacity.

Be sure any hitch points and the towing device are adequate.

Never straddle a wire rope cable or similar device, nor allow others to do so.

Know the maximum height and reach of your machine.

Always keep the ROPS (the top half of the cab shell) installed when operating the machine.

Always remove the ROPS (the top half of the cab shell) when preparing the machine for air drop.

Always kneel the machine and install the kneeling lock pins when driving and parking the machine in a transport airplane.

When operating this machine, follow the procedures and heed the warnings given in the “Operation Section” of this manual.

Machine Parking

Park the machine on level ground, with the blade resting on the ground, the transmission control lever in NEUTRAL, and the parking brake engaged. Block the drive belts (on downhill side) if the machine must be parked on uneven terrain. Move the electrical disconnect switch into the OFF position after parking the machine and stopping the engine.

For detailed parking instructions, refer to “Operation Section, Machine Parking” in this manual.

Specifications and Model Views

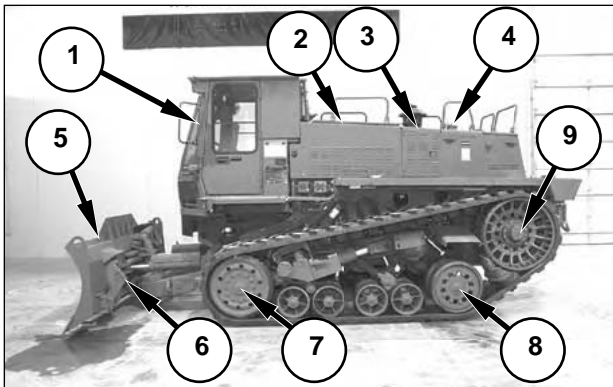

(1) Cab. (2) Cooling system. (3) Air filter compartment. (4) Fuel tank. (5) Blade. (6) Back ripper. (7) Front idler. (8) Rear idler. (9) Drive wheel.



(20) Lifting specifications plate.

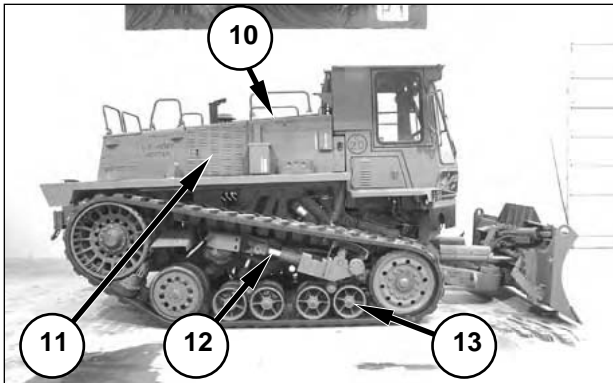

(10) Hydraulic oil tank. (11) Oil filter compartment. (12) Recoil cylinder. (13) Midroller.

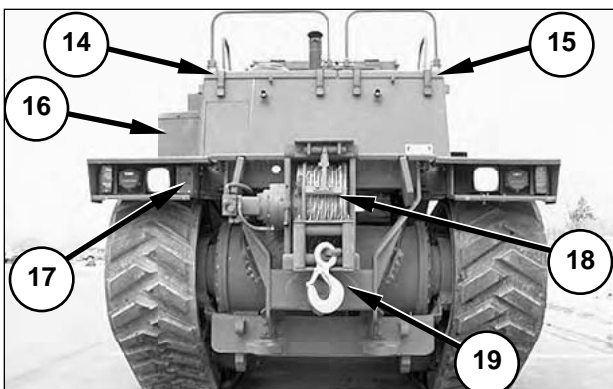

(14) Electrical panel and BII compartment. (15) Tool/battery compartment. (16) Optional arctic battery box. (17) Backup alarm. (18) Winch. (19) Pintle hook.

NOTE: If the machine is equipped with the optional arctic starting system, optional arctic battery box (16) is mounted on the left fender of the machine, as shown.

DEUCE Operational Specifications Standard Configuration

Overall Length:	5867 mm (231 in)
Overall Height ¹ :	2776 mm (109.3 in)
Overall Width:	2946 mm (116 in)
Special Shipping Width:	2591 mm (102 in)
Gross Vehicle Weight:	16 140 kg (35,500 lb)
Winch Capacity ² :	97 856 N (22,000 lb)
Maximum Cable Strength ³ :	195 725 N (44,000 lb)
Winch Drum Capacity ⁴ :	55 169 mm (181 ft)
Towing Capacity (1st Gear):	15 910 kg (35,000 lb)
Maximum Fording Depth:	914 mm (36 in)
Top Speed:	48 kph (30 mph)
Engine Horsepower:	138/197 kW (185/265 hp)
Electrical System:	24 Volts

NOTE: ¹ Actual machine height may vary due to suspension system characteristics. Always confirm machine height before the machine is shipped.

² Specification given is for five wraps of 5/8 inch cable.

³ Cable strength is given for 5/8 inch cable.

⁴ Drum capacity is five layers of 5/8 inch cable. Usable length is 48 768 mm (160 ft).

NOTE: Refer to "Operation Section, Transportation Information" in this manual for machine tie-down locations and the military load classification (MLC) number. Refer to "Maintenance Section, Lubricant Viscosities and Refill Capacities" for information about refill capacities.

Product Identification and Serial Number Locations

The Product Identification Number (PIN) is used to identify a powered machine that is designed for an operator to ride.

Caterpillar products, such as earthmoving equipment not designed for an operator to ride (engines, transmissions, etc.), are identified by serial numbers. Also, most major Caterpillar attachments are identified by serial numbers.

For quick reference, record the identification numbers in the spaces provided below the illustration photographs.



Plate (3) is located on the right control console inside the operator's compartment.

Cab Information Plate (Lower) _____

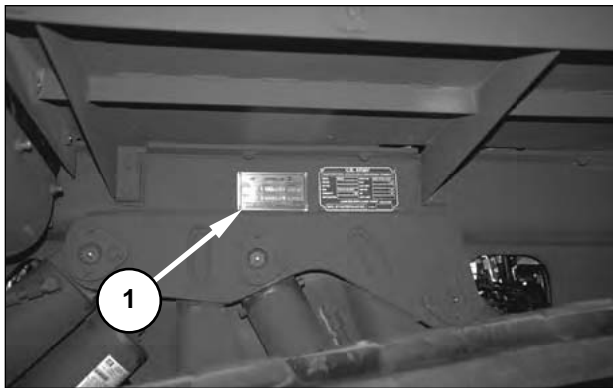

Plate (1) is mounted on the left side of the machine, under the walkway, near the suspension cylinder mounting points.

Machine PIN _____

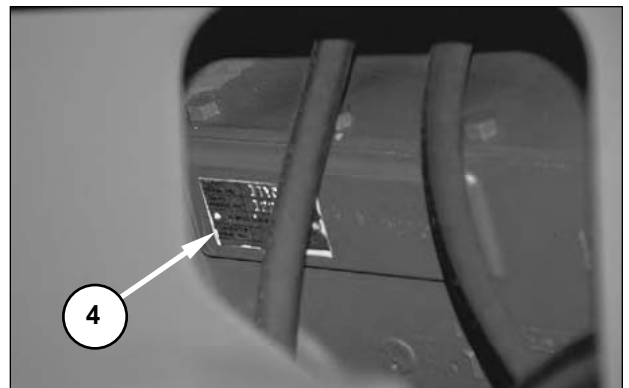

Plate (4) is located on the side of the transmission and is visible through a hole in the frame, on the right side of the machine.

Transmission Serial Number _____



Plate (2) is located on the top right corner of the cab, inside the operator's compartment.

Cab Information Plate (Upper) _____

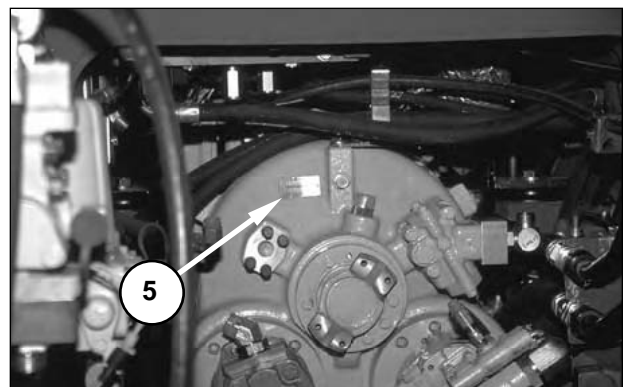

Plate (5) is mounted to the rear of the torque converter.

Torque Converter Serial Number _____

General Section

Product Information and Serial Number Locations

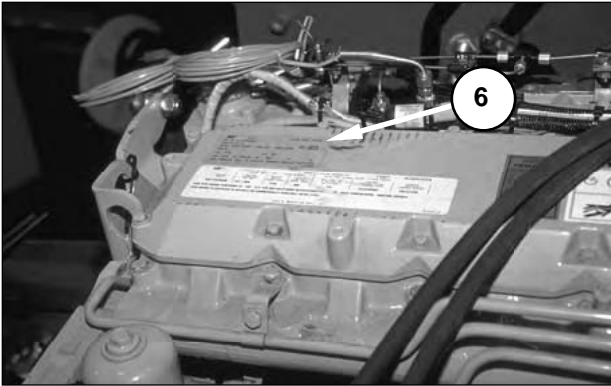

Plate (6) is mounted on the valve cover on the front end of the engine. This plate can be seen after the radiator is raised.

Engine Serial Number _____



Plate (7) is located on the right, rear side of the blade.

Bulldozer Serial Number _____

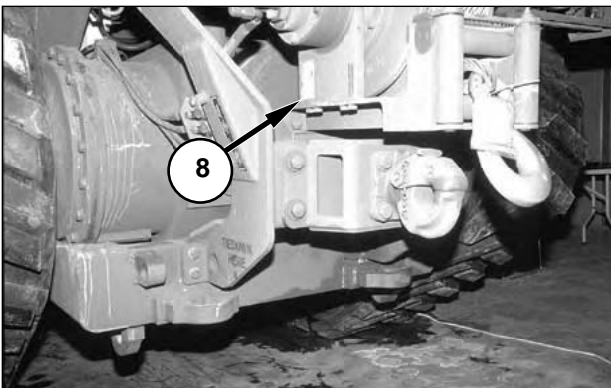

Plate (8) is located on the bottom, left side of the winch.

Winch Serial Number _____

Monitoring Systems and Cab Features

Switches

Engine Start Switch

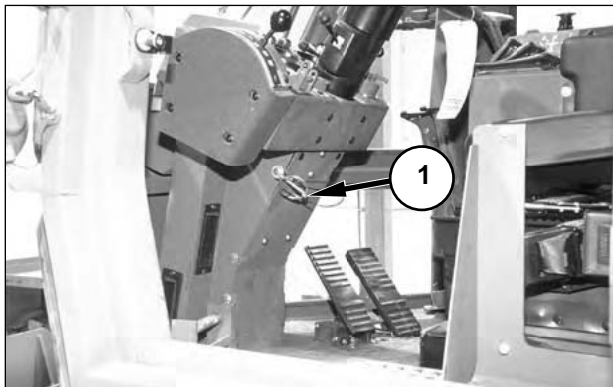
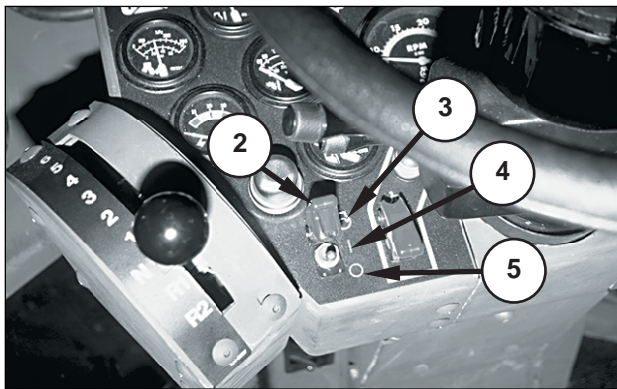
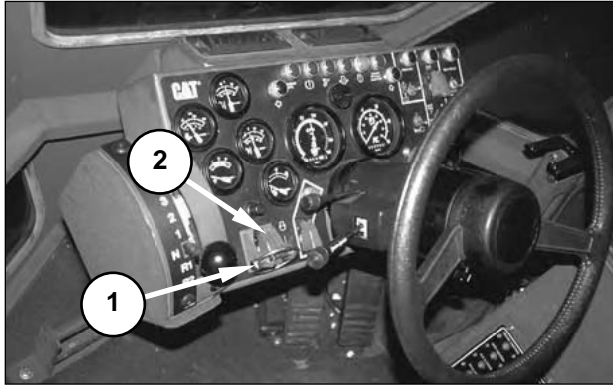

Remove locking pin (1) and lift switch cover (2) to access the switch. Store the locking pin as shown.

 OFF (5)—Move switch cover (2) all the way down to turn off electrical power to the machine and to shut off the engine.

When the switch is in the OFF position, power is blocked to all electrical components except for the engine heater, NATO slave receptacle, SINGARS, and PLGR.

 ON (4)—Move the switch into the center position to turn on the electrical power to the machine.

 START/INDICATOR CHECK (3)—Move and hold the switch all the way up to engage the starter and crank the engine. If the engine is already running, move the switch into the START position to turn on the indicator lights and check indicator operation.

NOTE: The starter will not engage if the transmission control lever is not in NEUTRAL, or the engine is already running.

NOTE: Refer to “Indicator Check Function,” in this section, for a description of the lamp check system.

NOTICE

Do not crank the engine for more than 30 seconds. Allow the starter to cool for two minutes before cranking again.

Turbocharger damage can result if the engine rpm is not kept low until the engine oil gauge verifies that the engine oil pressure is sufficient.

Engine Coolant Heater Switch

NOTE: The engine coolant heater switch is always installed on the machine. If the machine is equipped with the optional arctic starting system, the engine coolant heater switch is functional. If the machine is not equipped with the optional arctic starting system, the engine coolant heater switch is not functional.

NOTE: The engine coolant heater switch is always installed on the machine. If the machine is equipped with the optional arctic starting system, the engine coolant heater switch is functional. If the machine is not equipped with the optional arctic starting system, the engine coolant heater switch is not functional.

WARNING

Do not operate the engine coolant heater in an enclosed area. The heater produces combustion gases which may be harmful to your health. Always start and operate the heater in a well-ventilated area and, if in an enclosed area, vent the exhaust to the outside.

Improper use of the engine coolant heater can create a fire or cause an explosion. Do not operate the engine coolant heater while the machine is being refueled. Do not place combustible materials within 50.8 mm (2 in) of the exhaust system.



Press switch (6) down to turn the engine heater ON. Press the switch again to raise the switch and turn the engine heater OFF. An internal light in the switch will illuminate to indicate that the heater is functioning. After the switch has been turned off, the light will continue to illuminate until the coolant heater has completed a three-minute shut-down procedure.

NOTICE

Do not start the engine while the light in the engine coolant heater switch is on. The engine coolant heater requires three minutes to purge itself of diesel fumes. Damage to the engine coolant heater may result if the engine is started too soon after use.

NOTICE

Do not operate the engine coolant heater if the coolant is frozen.

Start-Aid Switch

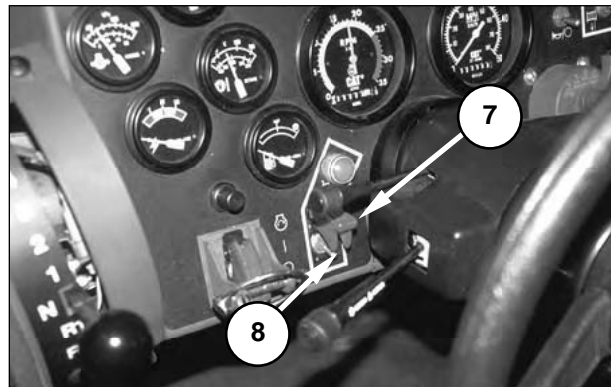

Lift switch cover (7) to access the switch.



Start-Aid Switch (8)—Move the switch up and hold it for three or more seconds, and then release it. Depending on the temperature of the intake air and engine coolant, a premeasured amount of ether is injected into the engine air intake manifold. When the start-aid system is functioning and the blackout light switch is in STOP LIGHT or SERVICE DRIVE, the start-aid indicator will turn on.

NOTICE

Use the ether sparingly. Excessive ether can cause piston and ring damage.

Do not inject ether unless the engine is rotating.

NOTE: The electronic control module (ECM) will allow the manual injection of ether if the intake air temperature is below 0°C (32°F), the engine coolant temperature is below 40°C (104°F), and the engine speed is below 1000 rpm.

NOTE: The ECM automatically turns on the engine intake air heater to assist in starting the engine, depending on the air temperature and the engine coolant temperature. It is permissible to manually inject ether using the start-aid switch when the intake air heater is turned on.

Engine Diagnostic Switch

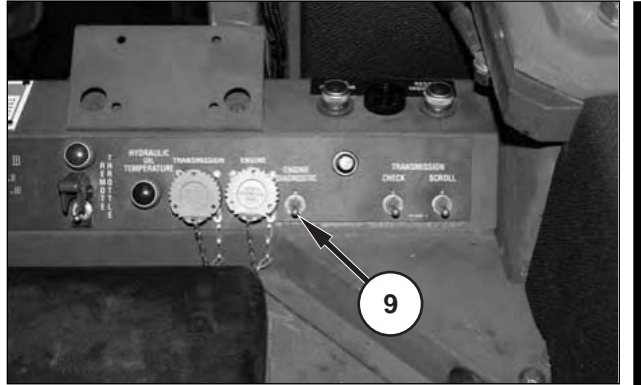

Move switch (9) up and hold it there for more than two seconds to activate the engine diagnostic system. For more information, refer to “Troubleshooting, Engine Diagnostic Codes” in this section.

Transmission Diagnostic Check Switch

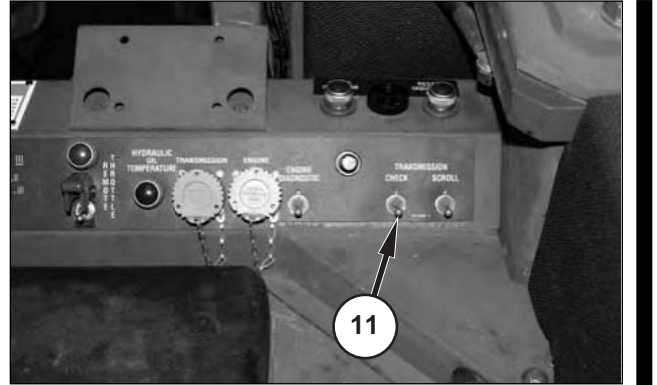

Transmission diagnostic check switch (11) is used by maintenance personnel to clear error codes in the electronic programmable transmission control unit (EPTC II) in the diagnostic mode.

Engine Controller Diagnostic Port

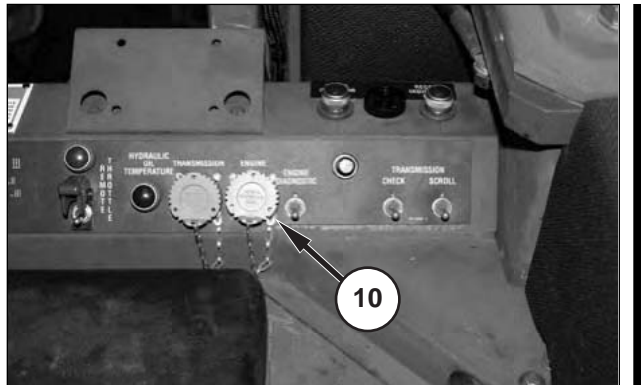

Port (10) is used by maintenance trained personnel to diagnose and calibrate the ECM.

Transmission Diagnostic Scroll Switch

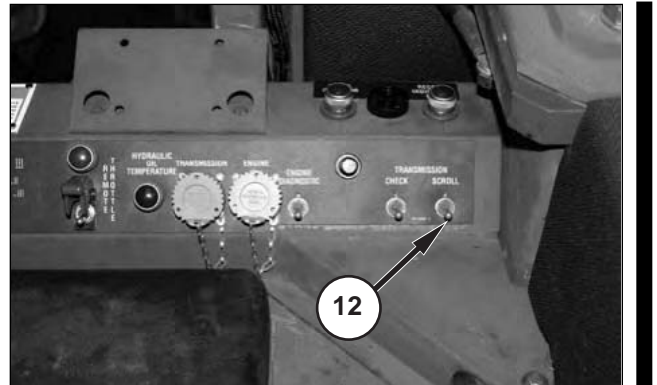

Transmission diagnostic scroll switch (12) is used by maintenance personnel to scroll through the faults stored in the diagnostic mode of the EPTC II.

Transmission Controller Diagnostic Port

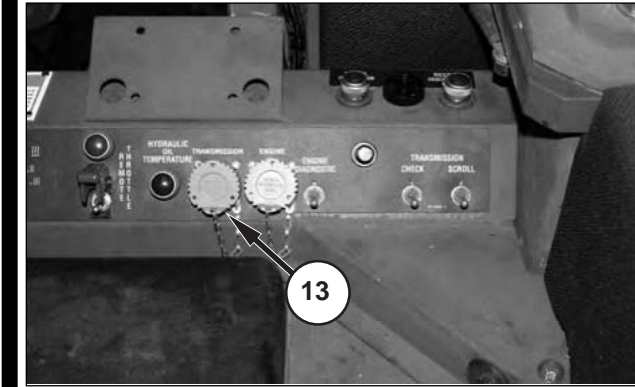

Port (13) is used by maintenance trained personnel to diagnose and calibrate the EPTC II.

Horn Enable Switch

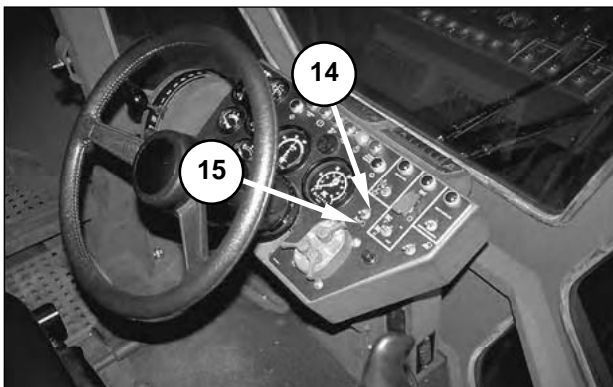

ON (14)—Move the switch into the ON position (up) to enable the horn and backup alarm.
OFF (15)—Move the switch into the OFF position (down) to disable the horn and backup alarm.

NOTE: The blackout light switch must be in the SERVICE DRIVE or STOP LIGHT position for the horn and backup alarm to operate.

Work Light Switch

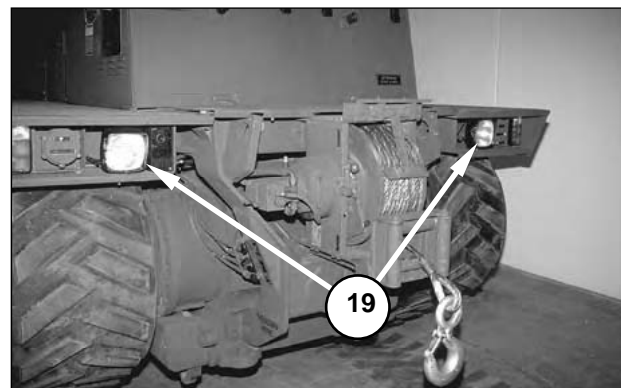
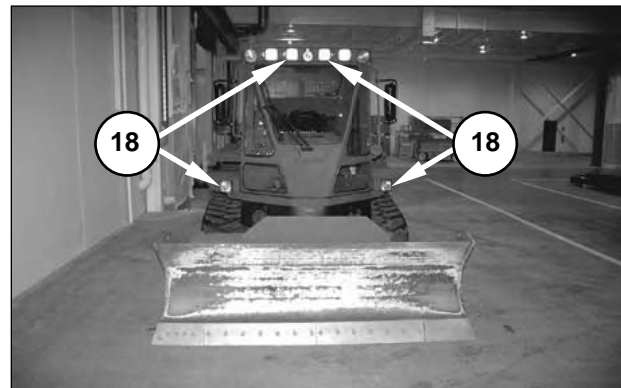
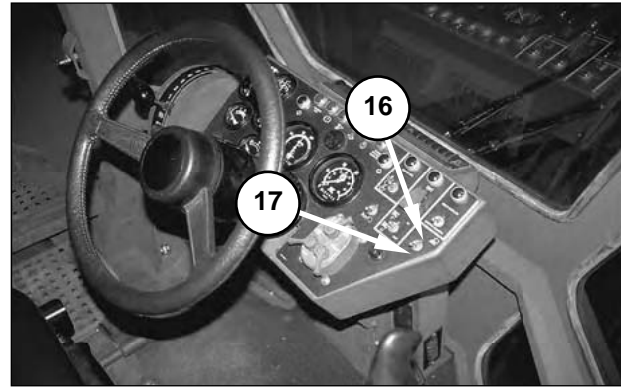

ON (16)—Move the switch up to turn on the front (18) and rear (19) working lights.
OFF (17)—Move the switch down to turn off the working lights

NOTE: The blackout light switch must be in the SERVICE DRIVE or STOP LIGHT position for the work lights to operate.

Blackout Light Switch

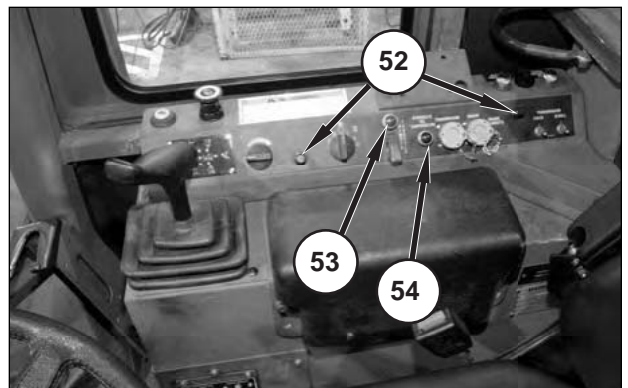
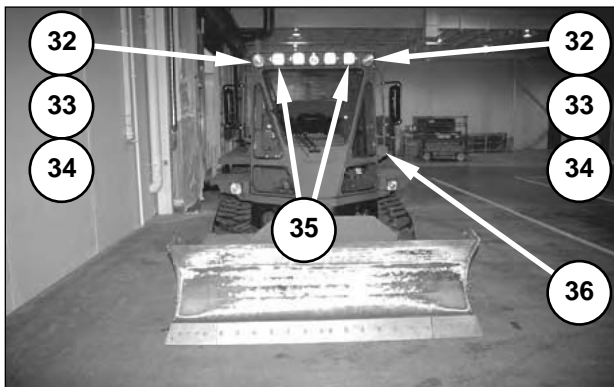
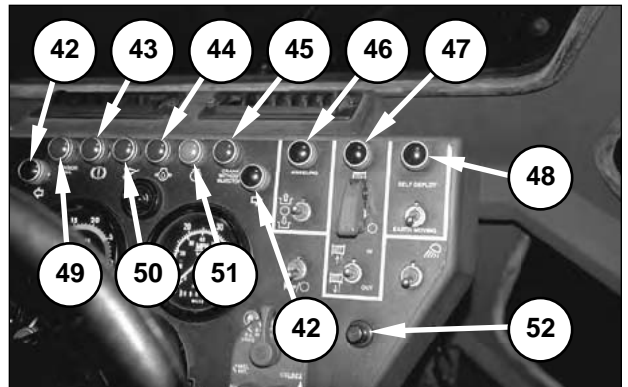
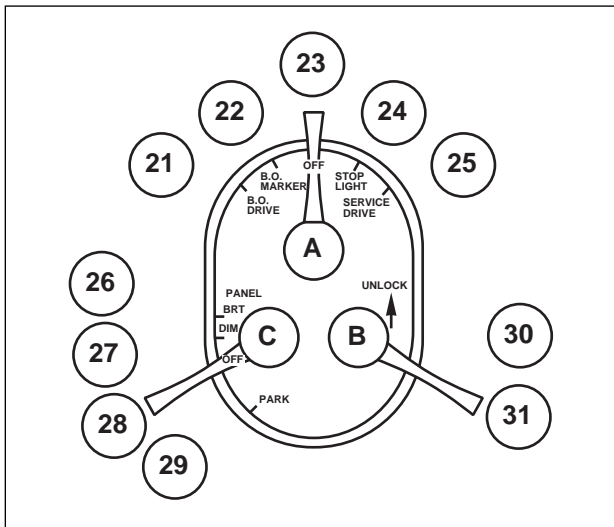
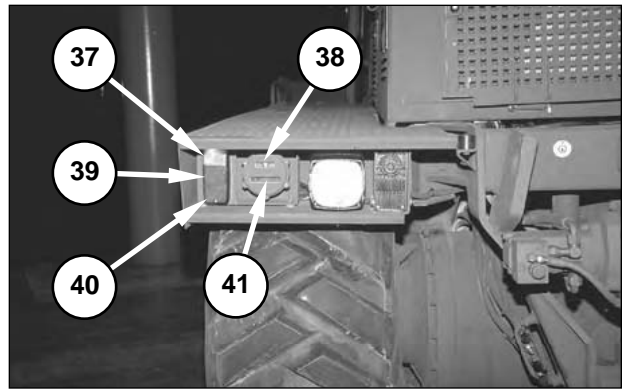

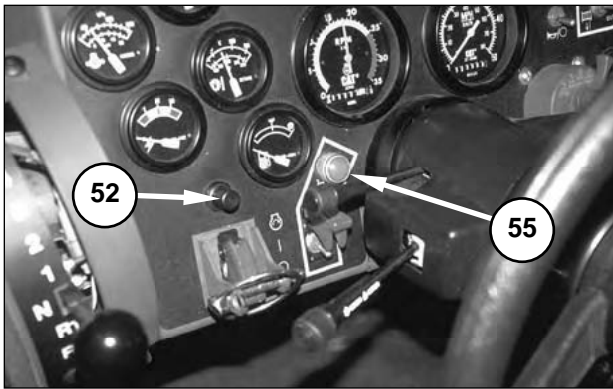

BLACKOUT DRIVE (21)—Move lever (A) into the BLACKOUT DRIVE position to enable the following lamps to function:

- Blackout Head Lamp (36)
- Right and Left Blackout Tail Lamps (41)
- Right and Left Blackout Marker Lamps (34)
- Right and Left Blackout Brake Lamps (38)
- Tension Fail Indicator (49)
- Low Brake Pressure Indicator (43)
- Blade Down Indicator (50)
- Engine Oil Pressure Indicator (44)
- Hydraulic Oil Temperature Indicator (54)

BLACKOUT MARKER (22)—Move lever (A) into the BLACKOUT MARKER position to enable the following lamps to function:

- Right and Left Blackout Tail Lamps (41)
- Right and Left Blackout Marker Lamps (34)
- Right and Left Blackout Brake Lamps (38)
- Tension Fail Indicator (49)

- Low Brake Pressure Indicator (43)
- Blade Down Indicator (50)
- Engine Oil Pressure Indicator (44)
- Hydraulic Oil Temperature Indicator (54)

OFF (23)—Move lever (A) into the OFF position to disable all lights except:

- Tension Fail Indicator (49)
- Low Brake Pressure Indicator (43)
- Blade Down Indicator (50)
- Engine Oil Pressure Indicator (44)
- Hydraulic Oil Temperature Indicator (54)

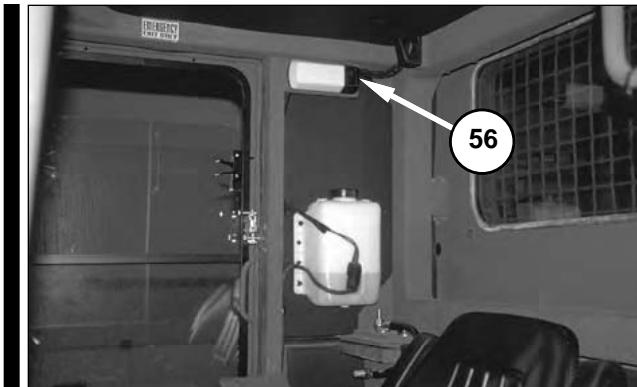

NOTE: Blackout switch (20) provides overall control of all lamps on the machine. The position of the three control levers on the blackout switch determines which machine lamps are illuminated and the illumination level of all instrument panel lamps.

UNLOCK (30)—Hold lever (B) in the UNLOCK position to allow lever (A) to move into BLACKOUT DRIVE (21), STOP LIGHT (24), or SERVICE DRIVE (25).

LOCK (31)—When lever (B) is in the LOCK position, movement of lever (A) is restricted.

NOTE: When lever (B) is in the LOCK position (31) and lever (A) is in the OFF position (23), lever (A) can only be moved into BLACKOUT MARKER (22). However, lever (A) can be moved into OFF (23) from BLACKOUT DRIVE (21), BLACKOUT MARKER (22), STOP LIGHT (24), or SERVICE DRIVE (25) with lever (B) in the LOCK position.

STOP LIGHT (24)—Move lever (A) into the STOP LIGHT position to enable the following lamps to function:

- Right and Left Brake Lamps (40)
- Interior Light (56)
- Right and Left Rear Working Lamps (19)
- Right and Left Center Work Lamps (18)
- Right and Left Front Work Lamps (18)
- Right and Left Turn Lamps (42, on panel)
- Rear Right and Left Turn Signal Lamps (37)
- Front Right and Left Turn Signal Lamps (33)
- Tension Fail Indicator (49)
- Low Brake Pressure Indicator (43)
- Blade Down Indicator (50)
- Engine Oil Pressure Indicator (44)
- Hydraulic Oil Temperature Indicator (54)
- Start-Aid Indicator (55)
- Check Engine Indicator (51)
- Crank-Without-Inject Indicator (45)
- Kneeling Mode Indicator (46)
- Winch Indicator (47)
- Self-Deploy Indicator (48)
- Remote Throttle Indicator (53)

NOTE: Lever (A) must be in SERVICE DRIVE position (25) for lever (C) to work.

SERVICE DRIVE (25), OFF (28)—Move lever (A) into the SERVICE DRIVE position and lever (C) into the OFF position to enable the following lamps to function:

- Right and Left Brake Lamps (40)
- Interior Light (56)
- Right and Left Rear Working Lamps (19)
- Right and Left Center Work Lamps (18)
- Right and Left Front Work Lamps (18)
- Right and Left Turn Lamps (42, on panel)
- Rear Right and Left Turn Signal Lamps (37)
- Front Right and Left Turn Signal Lamps (33)
- Right and Left Tail Lamps (39)
- Right and Left Front Marker Lamps (32)
- Right and Left Head Lamps (35)
- Tension Fail Indicator (49)
- Low Brake Pressure Indicator (43)
- Blade Down Indicator (50)
- Engine Oil Pressure Indicator (44)
- Hydraulic Oil Temperature Indicator (54)
- Start-Aid Indicator (55)
- Check Engine Indicator (51)
- Crank-Without-Inject Indicator (45)
- Kneeling Mode Indicator (46)
- Winch Indicator (47)
- Self-Deploy Indicator (48)
- Remote Throttle Indicator (53)

SERVICE DRIVE (25), PANEL BRIGHT (26)—Move lever (A) into the SERVICE DRIVE position and lever (C) into the PANEL BRIGHT position to enable the following lamps to function:

- Right and Left Brake Lamps (40)
- Interior Light (56)
- Right and Left Rear Work Lamps (19)
- Right and Left Center Work Lamps (18)
- Right and Left Front Work Lamps (18)
- Right and Left Turn Lamps (42, on panel)
- Rear Right and Left Turn Signal Lamps (37)
- Front Right and Left Turn Signal Lamps (33)
- Right and Left Tail Lamps (39)
- Right and Left Front Marker Lamps (32)
- Right and Left Head Lamps (35)
- All Panel and Gauge Lamps (52, bright level)
- Tension Fail Indicator (49)
- Low Brake Pressure Indicator (43)
- Blade Down Indicator (50)
- Engine Oil Pressure Indicator (44)
- Hydraulic Oil Temperature Indicator (54)
- Start-Aid Indicator (55)
- Check Engine Indicator (51)
- Crank-Without-Inject Indicator (45)
- Kneeling Mode Indicator (46)
- Winch Indicator (47)
- Self-Deploy Indicator (48)
- Remote Throttle Indicator (53)

SERVICE DRIVE (25), DIM (27)—Move lever (A) into the SERVICE DRIVE position and lever (C) into the DIM position to enable the following lamps to function:

- Right and Left Brake Lamps (40)
- Interior Light (56)
- Right and Left Rear Work Lamps (19)
- Right and Left Center Work Lamps (18)
- Right and Left Front Work Lamps (18)
- Right and Left Turn Lamps (42, on panel)
- Rear Right and Left Turn Signal Lamps (37)
- Front Right and Left Turn Signal Lamps (33)
- Right and Left Tail Lamps (39)
- Right and Left Front Marker Lamps (32)
- Right and Left Head Lamps (35)
- All Panel and Gauge Lamps (52, dim level)
- Tension Fail Indicator (49)

- Low Brake Pressure Indicator (43)
- Blade Down Indicator (50)
- Engine Oil Pressure Indicator (44)
- Hydraulic Oil Temperature Indicator (54)
- Start-Aid Indicator (55)
- Check Engine Indicator (51)
- Crank-Without-Inject Indicator (45)
- Kneeling Mode Indicator (46)
- Winch Indicator (47)
- Self-Deploy Indicator (48, dim level)
- Remote Throttle Indicator (53)

SERVICE DRIVE (25), PARK (29)—Move lever (A) into the SERVICE DRIVE position and lever (C) into the PARK position to enable the following lamps to function:

- Right and Left Brake Lamps (40)
- Interior Light (56)
- Right and Left Rear Working Lamps (19)
- Right and Left Center Work Lamps (18)
- Right and Left Front Work Lamps (18)
- Right and Left Turn Lamps (42, on panel)
- Rear Right and Left Turn Signal Lamps (37)
- Front Right and Left Turn Signal Lamps (33)
- Right and Left Tail Lamps (39)
- Right and Left Front Marker Lamps (32)
- All Panel and Gauge Lamps (52, dim level)
- Tension Fail Indicator (49)
- Low Brake Pressure Indicator (43)
- Blade Down Indicator (50)
- Engine Oil Pressure Indicator (44)
- Hydraulic Oil Temperature Indicator (54)
- Start-Aid Indicator (55)
- Check Engine Indicator (51)
- Crank-Without-Inject Indicator (45)
- Kneeling Mode Indicator (46)
- Winch Indicator (47)
- Self-Deploy Indicator (48, dim level)

Gauges

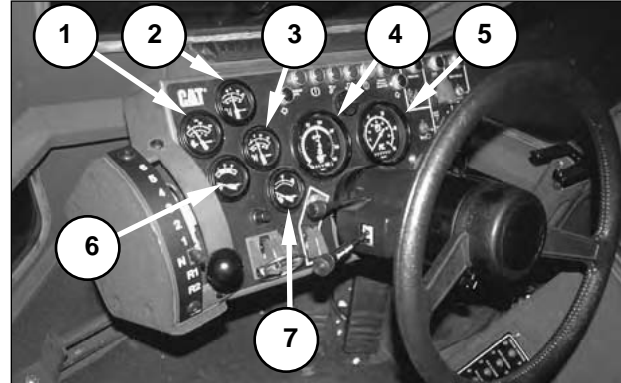

Engine Oil Pressure (1)—Indicates the engine oil pressure in kPa (psi).

NOTE: The normal engine oil pressure range should be between 250 and 450 kPa (30 and 70 psi) when the engine is running at full speed with SAE 15W40 oil at operating temperature.



Engine Coolant Temperature (2)—Indicates the temperature of the engine coolant in degrees celsius and degrees fahrenheit. If the engine coolant temperature increases above 110°C (230°F), stop operation of the machine and allow the engine to idle for a few minutes. If the coolant temperature will not return to 110°C (230°F) or less during normal working conditions, stop the machine and investigate the cause of engine overheating.



Transmission Oil Temperature (3)—Indicates the temperature of the transmission system oil in °C (°F). If the transmission system oil temperature increases above 110°C (230°F), stop operation of the machine and allow it to idle for a few minutes. If the transmission oil temperature will not return to 110°C (230°F) or less during normal working conditions, stop the machine and investigate the cause of the transmission system overheating.



Engine RPM (4)—Indicates the engine speed in revolutions (X100) per minute.

The service hour meter is located on the engine rpm gauge.

Speedometer (5)—Indicates machine ground speed in miles-per-hour and kilometers-per-hour.



Voltmeter (6)—Indicates the electrical system voltage at different operating conditions.

With the start switch in the ON position and the engine NOT RUNNING, a reading in the first red zone indicates dead batteries.

With the start switch in the ON position and the engine NOT RUNNING, a reading in the black-and-white striped zone indicates that the batteries are not fully charged.

With the start switch in the ON position and the engine NOT RUNNING, a reading in the first green zone indicates the batteries are fully charged.

With the ENGINE RUNNING, a reading anywhere below the second green zone (normal operating range) indicates that the alternator is not producing enough voltage to charge the batteries and supply current to the electrical accessories.

With the ENGINE RUNNING, a reading in the second red zone indicates that the alternator is overcharging.

With the ENGINE RUNNING, if the pointer registers in the first green band, or either red bands, have the problem corrected.



Fuel Level (7)—Indicates the approximate quantity of fuel in the fuel tank.

NOTICE

To prevent the fuel from overheating when the machine is operated in ambient temperatures above 38°C (100°F), the fuel level should be maintained above one-half of a tank. Overheated fuel can cause reduced power and possibly damage the fuel system.

NOTE: The fuel tank capacity is 341 L (90 U.S. gal).

Indicators

The indicators are color coded to indicate the importance.

- **Green**—A green indicator means that the indicated system is in operation.
- **Orange**—An orange indicator means to notice that an automatically controlled system is operating.
- **Red**—A red indicator means to pay immediate attention and correct the indicated problem immediately.

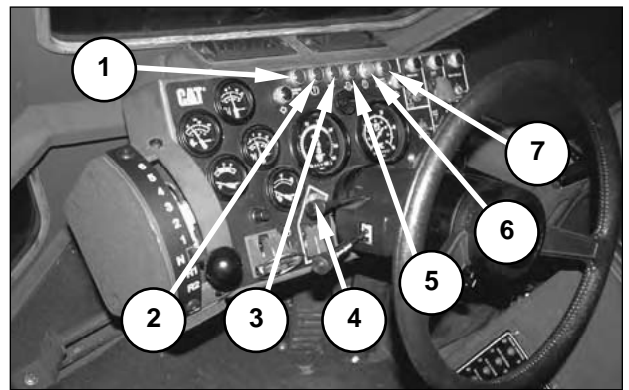

Tension Fail (1)—Indicates low oil pressure in the drive belt tension system.

! WARNING

Do not operate the machine when the tension fail warning indicator is lit. Braking efficiency is reduced if there is not enough drive belt tension. Personal injury or damage to the machine can occur if there is not enough braking capacity to stop the machine.



Low Brake Pressure (2)—Indicates low oil pressure in the brake system.

! WARNING

Do not operate the machine when the low brake pressure warning indicator is lit. Braking efficiency is reduced if there is not enough brake system pressure. Personal injury or damage to the machine can occur if there is not enough braking capacity to stop the machine.



Blade Down (3)—Indicates that the blade is not in the full up position when the machine is in SELF-DEPLOY mode.

NOTE: If the blackout switch is in the STOP LIGHT or SERVICE DRIVE position, the blade down alarm will sound when blade down indicator (3) is illuminated.



Start-Aid (4)—Indicates the operation of the start-aid system (intake air heater or ether injection).

NOTE: The blackout switch must be in the STOP LIGHT or SERVICE DRIVE position for start-aid indicator (4) to function.



Engine Oil Pressure (5)—Indicates that there is not enough engine oil pressure. The oil pressure indicator illuminates when the oil pressure is 35 ± 21 kPa (5 ± 3 psi)

NOTICE

Do not continue to operate the machine if the engine oil pressure indicator is on, or if the engine oil pressure gauge indicates an engine oil pressure of less than 50 kPa (10 psi), 15 seconds after starting the engine. Stop the machine immediately and inform Unit Maintenance of the problem. Do not operate the machine until the cause of the low engine oil pressure has been corrected.



Check Engine (6)—Indicates the presence of a fault code in the engine electronic control module. Refer to “Troubleshooting, Engine Diagnostic Codes” in this manual for information on diagnostic codes.

NOTE: The blackout switch must be in the STOP LIGHT or SERVICE DRIVE position for check engine indicator (6) to function.

Crank-Without-Inject (7)—Indicates the fuel delivery system has been disabled, to allow the engine to be turned over without starting. This operational mode is used only by service personnel to repair the engine.

NOTE: The blackout switch must be in the STOP LIGHT or SERVICE DRIVE position for crank-without-inject indicator (7) to function.

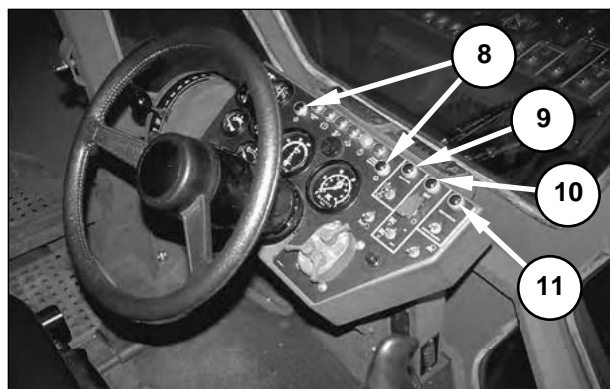

Turn Signal (8)—Indicates the direction of the turn signal.

NOTE: The blackout switch must be in the STOP LIGHT or SERVICE DRIVE position for turn signal indicators (8) to function.

Kneeling (9)—Indicates that the machine is fully lowered into the kneeling mode.

NOTE: The blackout switch must be in the STOP LIGHT or SERVICE DRIVE position for kneeling mode indicator (9) to function.



Winch (10)—Indicates that the winch control system is activated.

NOTE: The blackout switch must be in the STOP LIGHT or SERVICE DRIVE position for winch indicator (10) to function.

Self-Deploy Mode (11)—Indicates that the suspension is active and the machine is in SELF-DEPLOY mode.

NOTE: The blackout switch must be in the STOP LIGHT or SERVICE DRIVE position for self-deploy mode indicator (11) to function.

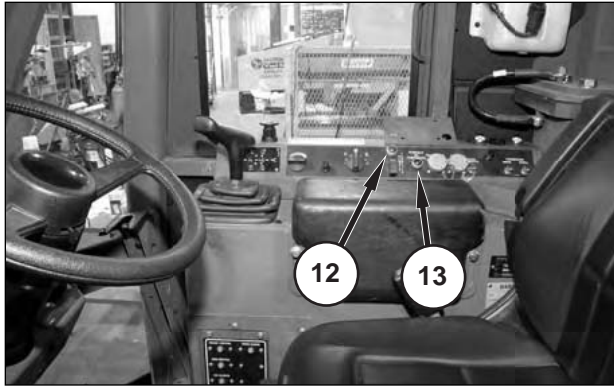

Remote Throttle (12)—Indicates that the engine speed is being controlled by the remote throttle switch.

NOTE: The blackout switch must be in the STOP LIGHT or SERVICE DRIVE position for remote throttle indicator (12) to function.

Hydraulic Oil Temperature (13)—Indicates that the hydraulic oil temperature is too high. If this light comes on during operation, slow the machine until the light goes off. If the light continues to illuminate during normal operating conditions, have the cause of the hydraulic system overheating investigated and corrected.

NOTE: The blackout switch must be in the STOP LIGHT or SERVICE DRIVE position for hydraulic oil temperature indicator (13) to function.

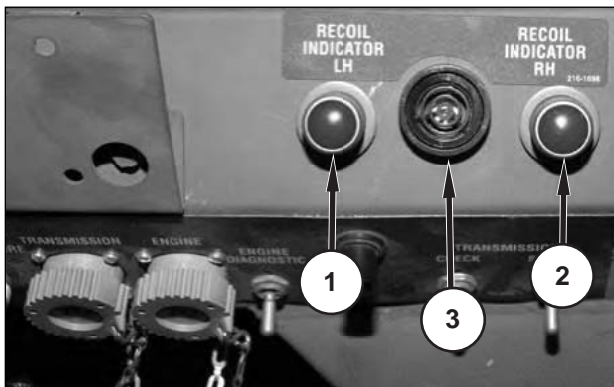

Recoil Alert

Recoil Indicator LH (1) and/or Recoil Indicator RH (2) will illuminate, and a warning buzzer (3) will sound when the machine encounters an obstruction in the undercarriage and the recoil cylinder is compressed. If the recoil alert sounds, stop the machine and reverse direction to clear debris from the undercarriage.

NOTICE

During earthmoving operations it is possible to collapse the recoil cylinder completely. To reduce the possibility of breaking track belts in this condition a recoil alarm has been added to the machine to alert the operator that a hazardous condition exists.

NOTE: The position of the blackout switch does not effect the recoil alert warning lights.

Indicator Check Function



When the engine is running, the start position of the engine start switch (1) will perform an indicator check function.

NOTE: The ECM will disengage the starter at 600 rpm. Holding the starter engaged after the engine has started will not damage the starter.

When engine start switch (1) is held in the START position, the following indicators will turn on to test for failed indicator bulbs. Have Unit Maintenance personnel replace any indicator bulbs that do not turn on during the check.

NOTE: The blackout light switch must be in the STOP LIGHT or SERVICE DRIVE position for the indicators to turn on in the indicator check function.

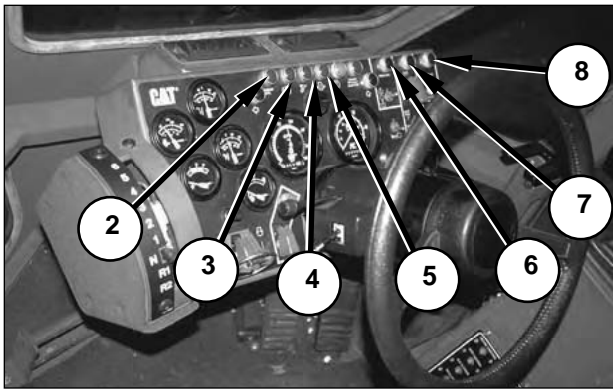

Steering Column

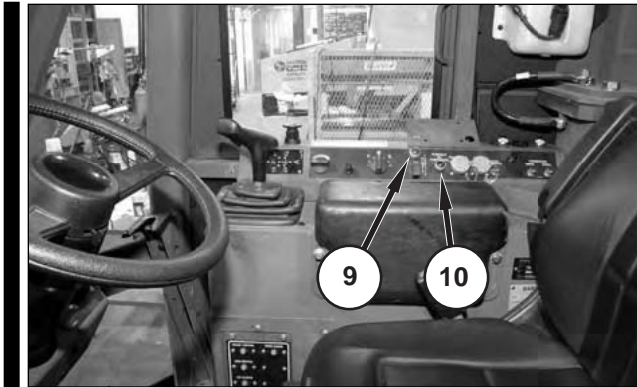
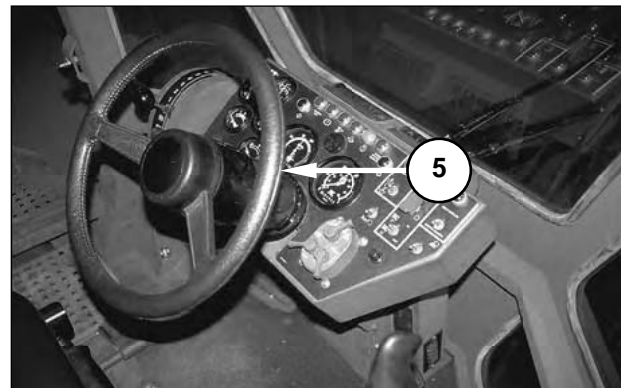
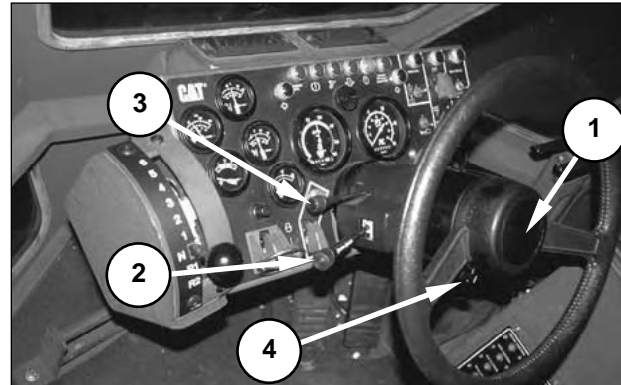

(2) Tension Fail.



(3) Low Brake Pressure.



(4) Blade Down.



(5) Engine Oil Pressure.

(6) Kneeling.



(7) Winch

(8) Self-Deploy Mode.

(9) Remote Throttle.

(10) Hydraulic Oil Temperature.

Horn (1)—Press the center button in the steering wheel to sound the horn.

NOTE: The horn switch must be ON, and the blackout switch must be in the STOP LIGHT or SERVICE DRIVE position for horn (1) to function.

Turn Signal (2)—Move lever (2) forward to activate the right turn signal. Move lever (2) rearward to activate the left turn signal.

NOTE: The blackout switch must be in the STOP LIGHT or SERVICE DRIVE position for turn signal (2) to function.

Wiper/Washer (2)—Turn the knob on the end of lever (2) to turn on the wiper. There are two positions corresponding to two wiper speeds. Press the knob in to activate the washer.

Tilt (3)—Lift and hold lever (3) to tilt the steering column. Release the lever when the steering column is in the desired position.

Extend and Retract (4)—Slide the lever to the right to extend or retract the steering column. Slide the lever to the left to lock the steering column in the desired location.



Hazard Warning Lights (5)—Push center button (5) in to turn on the flashers. Pull the outer collar out to turn off the flashers.

NOTE: The blackout switch must be in the STOP LIGHT or SERVICE DRIVE position for hazard warning lights switch (5) to function.

Cooling Fan

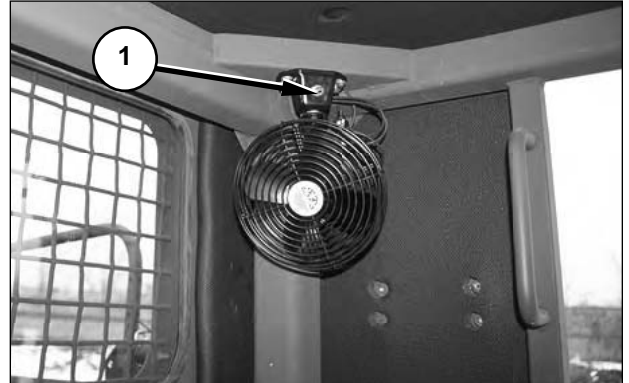

There are two cooling fans mounted in the cab. One fan is mounted in the left rear corner of the cab. The other fan is mounted in the right front corner of the cab.

Off—Move switch (1) to the center position to turn the fan off.

High—Move switch (1) to the left to operate the fan at high speed.

Low—Move switch (1) to the right to operate the fan at low speed.

Arm Rest

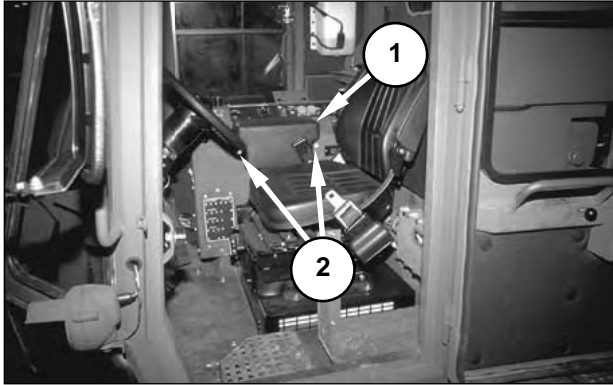

Loosen bolts (2). Move arm rest (1) up or down to the desired position, and tighten the bolts.

Interior Light

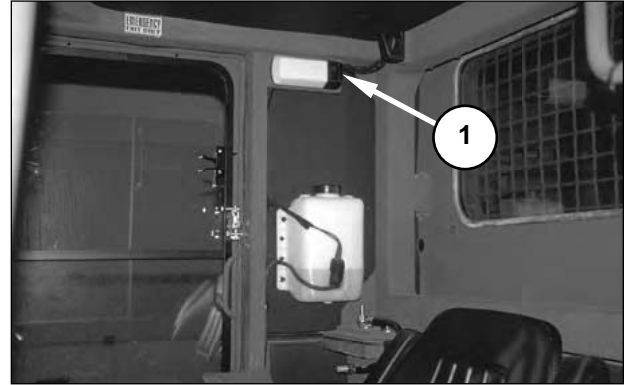

ON—Push the bottom of switch (1) in to turn ON the interior light.

OFF—Push the top of switch (1) in to turn OFF the interior light.

NOTE: The blackout switch must be in the STOP LIGHT or SERVICE DRIVE position for the interior lamp to function.

Cab Door

Open From Outside



Pull handle (1) up to release the latch and open the door.

Secure In Hold-Open Position



Press door (2) firmly against the side wall of the cab to engage the latch and secure the door in the open position.

Release From Hold-Open Position

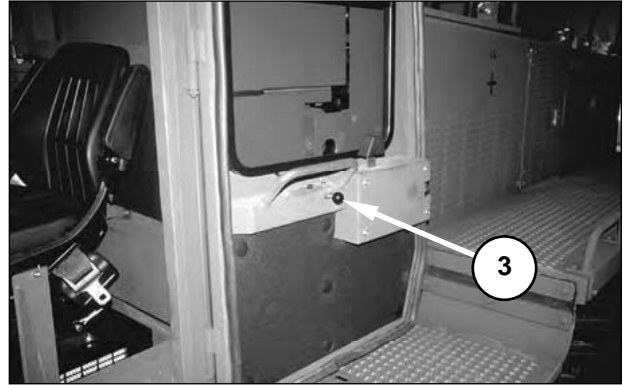

Move lever (3) towards the front of the machine to release the door from the hold-open position.

Open From Inside

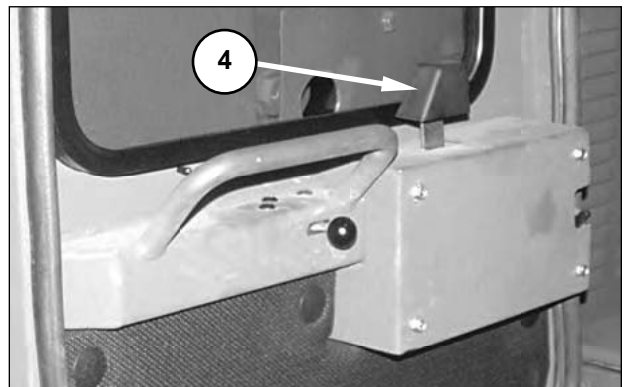

Push lever (4) towards the front of the machine to release the door from the inside.

Side Window

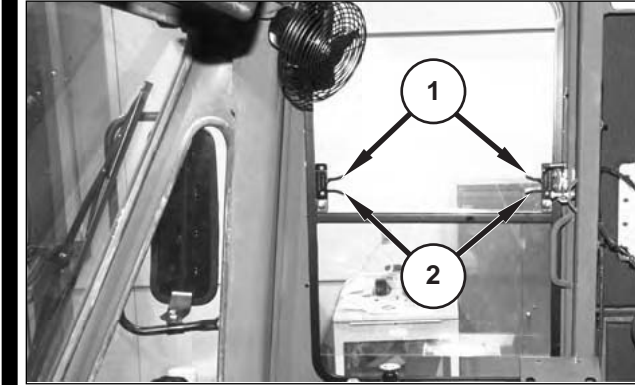

Squeeze levers (1 and 2) on both sides of the window to raise or lower the window. Release the levers when the window is in the desired position.

Alternate Exit

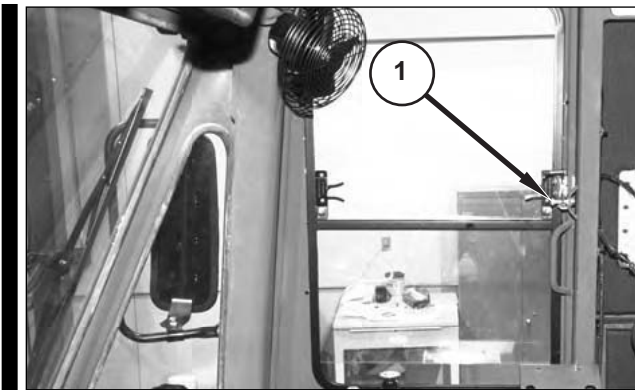

Push lever (1) up and toward the window to release the latch. Swing the window towards the front of the machine to open, and exit through the window frame.

Air Conditioning/Heating Controls

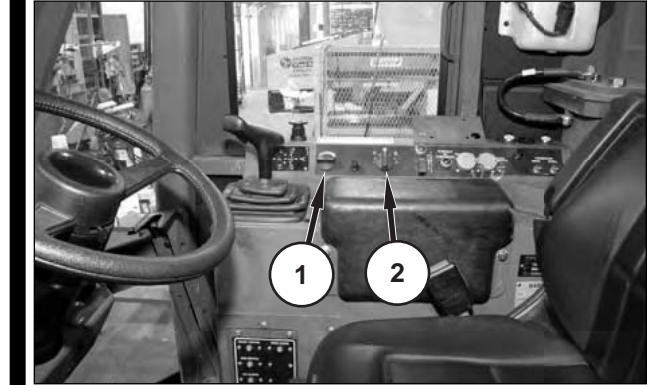

Air Conditioning

Turn switch (2) counterclockwise (left) to activate the air conditioner. There are three positions which correspond to three speeds for the blower fan.

Turn knob (1) clockwise (right) for cooler air.

Heating

Turn switch (2) clockwise (right) to activate the heater. There are three positions which correspond to three speeds for the blower fan.

Turn knob (1) counterclockwise (left) for warmer air.

Ventilation Louvers

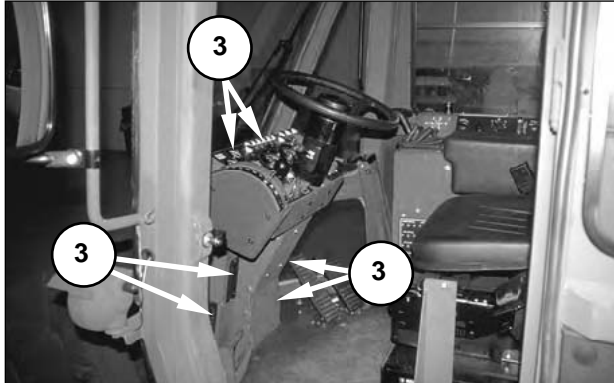

Rotate and tilt louvers (3) to direct the air flow in the desired direction.

Circuit Breakers

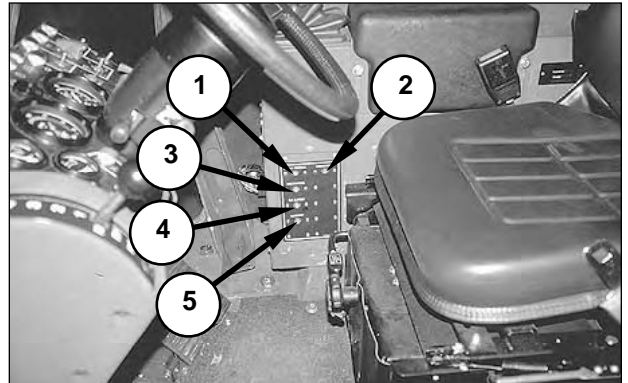

- (1) Engine Control—20 Amps. This circuit breaker also protects the intake air heater relay.
- (2) Dome/Horns—15 Amps. This circuit breaker also protects the remote throttle indicator lamp.
- (3) Transmission Control—20 Amps. This circuit breaker also protects the self-deploy/earthmoving solenoids, parking brake and blade lock valve.
- (4) A/C Blower—15 Amps.
- (5) Auxiliary—15 Amps. This circuit breaker also protects the suspension charging system, instrument panel gauges and the steering control system.

NOTE: This machine is equipped with two circuit breaker panels. For location of the second circuit breaker panel, refer to “Machine Features, Main Circuit Breakers” in this section.

Seat Belt

Always check the condition of the seat belt and its mounting hardware before operating the machine.



Replace the seat belt at least once every three years, regardless of its appearance. Date label (1) indicates the belt fabrication date. Replace the belt if the date on the label is older than three years.

Inspect for worn or frayed webbing.

Check for a worn or damaged buckle. Replace the belt, buckle or slide if they are worn or damaged.

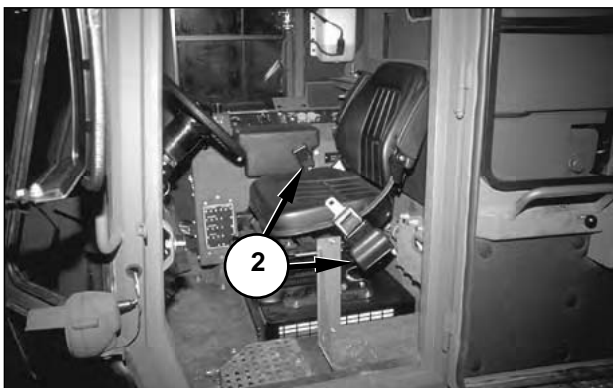

Inspect the belt mounting hardware at locations (2). Have Unit Maintenance replace any damaged or worn hardware. Keep the mounting bolts tight.

Seat Belt Adjustment

The seat belt is equipped with an automatic locking retractor. This retractor will lock if the belt is pulled or jerked after the belt is pulled out of the retractor.

The buckle end of the seat belt is equipped with a comfort ride sleeve. This sleeve will allow the operator limited movement with the seat belt fastened.

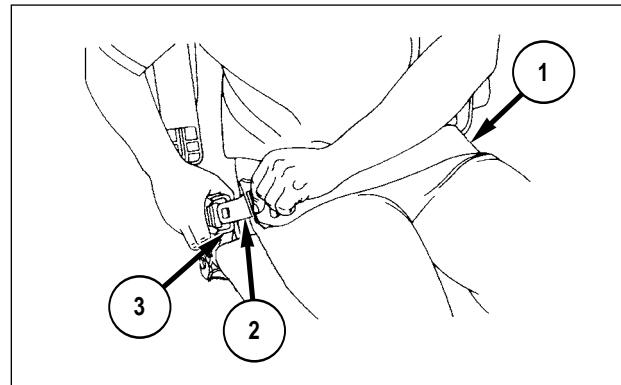

Pull seat belt (1) out of the retractor in a continuous motion.

Fasten seat belt catch (2) into buckle (3). Check to make sure the seat belt is placed low across the lap.

The retractor will adjust the belt length and lock in place. The operator has limited movement while wearing the seat belt.

To Release the Seat Belt

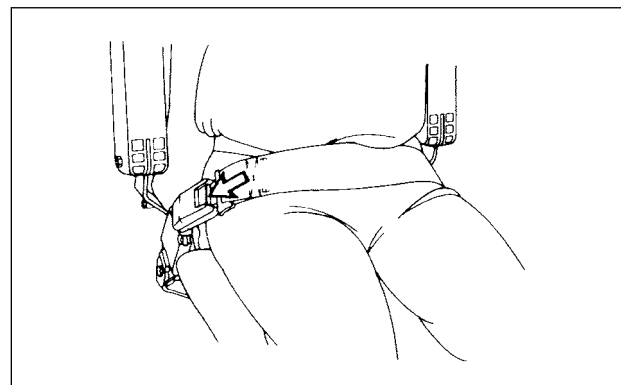

Push the release button on the buckle to release the seat belt. The seat belt will automatically retract into the retractor.

Seat Adjustment

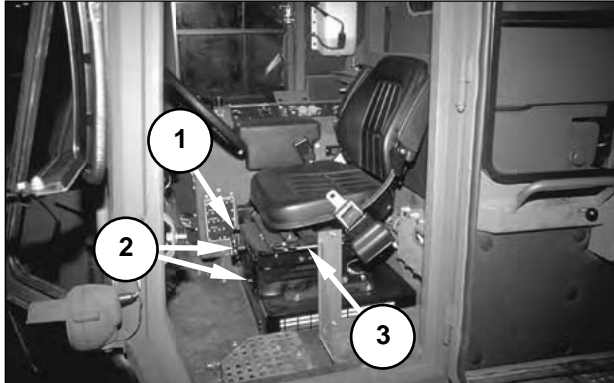

Raise/Lower (1)—Lift and hold the lever up, raise or lower the seat, and then release the lever to lock the seat at the desired height.

Suspension (2)—Turn the knob clockwise to increase the stiffness of the suspension. Turn the knob counterclockwise to decrease the stiffness of the suspension. When the desired stiffness is achieved, a yellow indicator will be flush with the end of a small tube at the lower left front of the seat frame.

Fore/Aft (3)—Move and hold the lever out (away from the seat cushion), and slide the seat fore or aft. Release the lever when the seat is in the desired position.

Mirrors

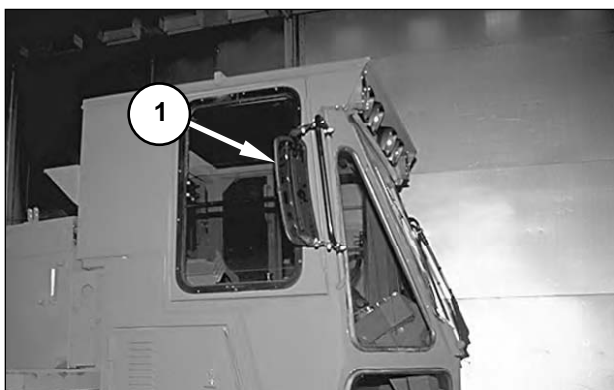

Move mirror (1) by hand to set the correct angle for maximum visibility. The machine is equipped with a mirror on both sides of the cab. Fold the mirrors against the side of the cab when operating in areas where the mirrors can be damaged by branches or other objects.

Rear View Mirror

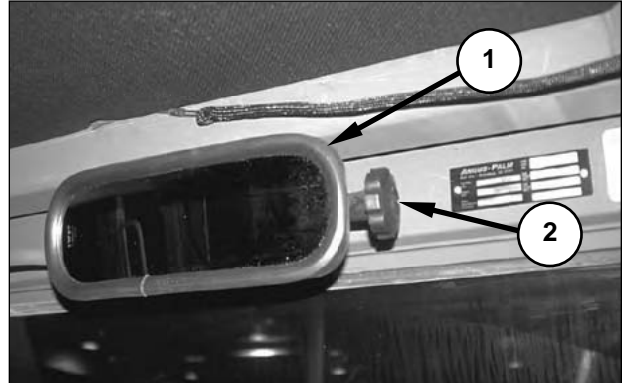

Loosen knob (2) and rotate mirror (1) up or down. Tighten the knob when the mirror is in the desired location.

PLGR Bracket



Mounting bracket (1) for the Precision Lightweight GPS Receiver (PLGR) is located on the control console to the right of the operator.

NOTE: Refer to Appendix F for PLGR installation instructions.

SINGGARS Bracket Installation



Single Channel Ground and Airborne Radio System (SINGGARS) mounting bracket installation location (1) is to the left of the operator's seat, on the cab floor.

NOTE: For instructions to install the SINGGARS, unit maintenance should refer to TB11-5820-890-20-113, *Installation Instructions for Installation Kit, Electronic Equipment, MK-2901/VRC (NSN 5895-01-458-1547) (EIC: N/A) to Permit Installation of Radio Sets AN/VRC-87/88/89 Series in a DEUCE Vehicle*. This publication should be read and understood before the SINGGARS is installed.

PLGR/SINGGARS Power Strip

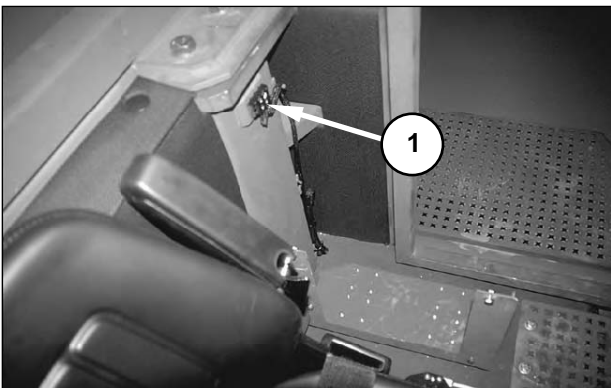

Power strip (1) for the PLGR and SINGGARS is located behind and to the left of the operator's seat.

NOTE: The capacity of the power strip is 10 amps at 24 volts. The power strip is protected by the start circuit breaker. Refer to "Operation Section, Machine Features, Main Circuit Breakers" in this manual for the location of this circuit breaker.

Rifle Bracket

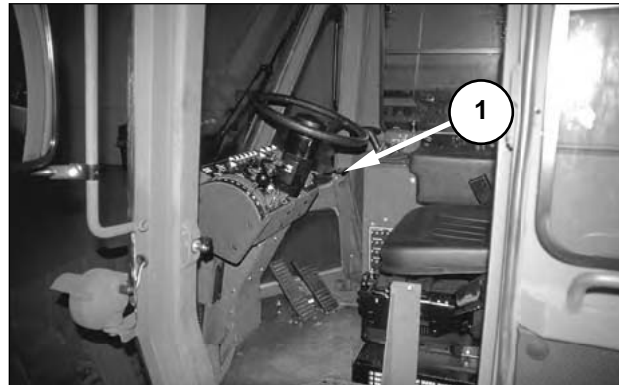

Rifle bracket (1) is located in front of the right console, on the right side of the cab.

Windshield Washer Fluid Bottle

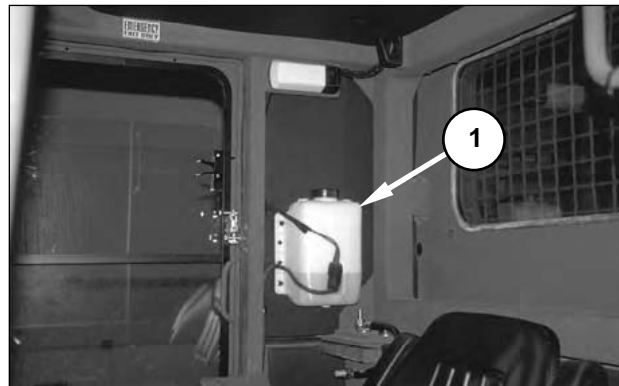

Windshield washer fluid bottle (1) is located on the right side wall of the cab.

Coat Hook

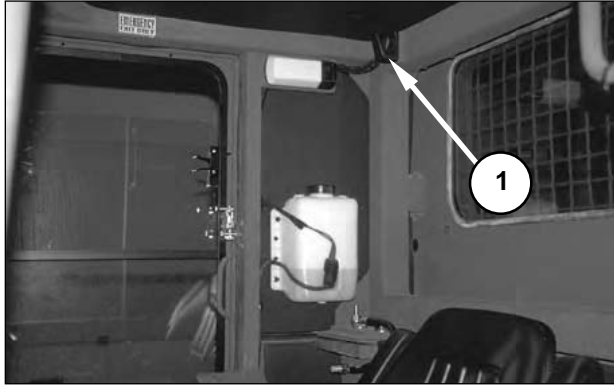

Coat hook (1) is located in the right rear corner of the cab.

Rear Windshield Guard

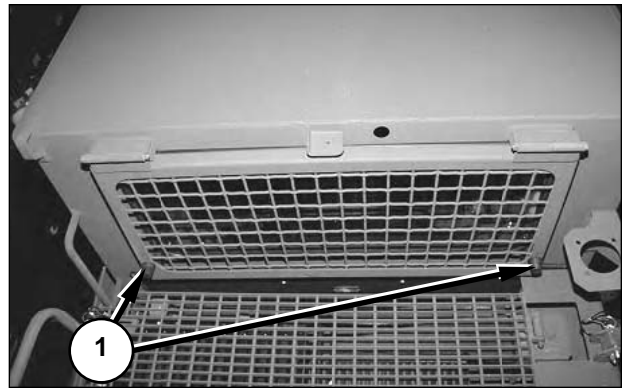

To raise rear windshield guard (1), pull out sharply on the lower corners to release the guard from the rubber fasteners. Raise the guard and allow it to rest on the top of the cab.

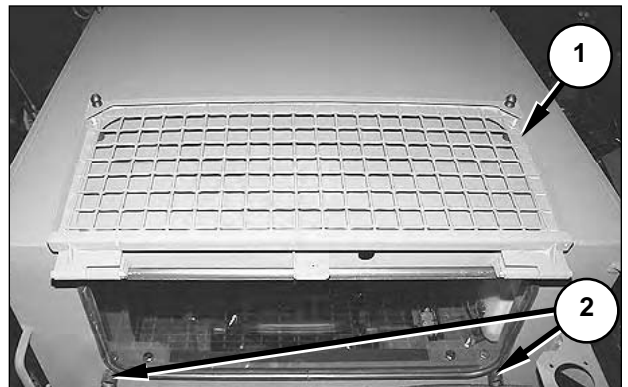

To lower rear windshield guard (1), raise the guard off the top of the cab and rotate it down in position over the rear window. Press sharply on the lower corners of the guard to secure it in rubber fasteners (2).

NOTE: Rear windshield guard (1) provides protection for the operator when the winch is operated. The rear windshield guard should only be raised to clean or replace the rear windshield. At all other times, the rear windshield guard should be lowered and secured in rubber fasteners (2).

WARNING

Operation of the winch while rear windshield guard (1) is in the raised position could result in injury or death.

Machine Features

Parking Brake

NOTICE

Do not apply the parking brake while the machine is moving, unless an emergency exists.

WARNING

With the engine running, this machine will spot turn when the steering wheel is turned, even if the transmission is in NEUTRAL.

To avoid personal injury due to unexpected movement, engage the parking brake and make sure the area is free of personnel before starting the engine.



 Parking brake switch (1) is located on the control console, to the right of the operator's seat.

Pull up on the switch to apply the parking brake.

NOTE: A lamp inside parking brake switch (1) will indicate that the brake is applied.

Push down on the switch to release the parking brake.

NOTE: The parking brake must be applied for the engine starter to function.

Service Brakes

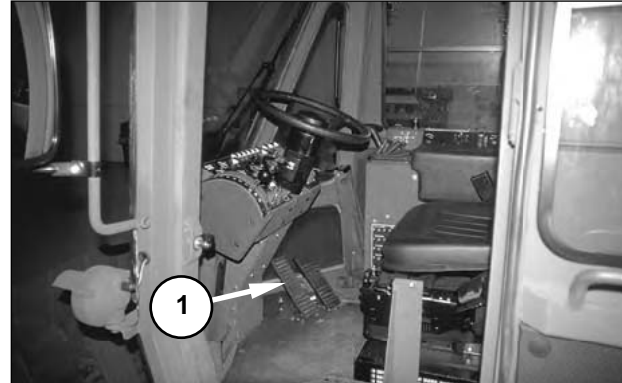

Depressing pedal (1) applies equal braking torque to both front idlers. Increasing pedal stroke increases brake torque.

WARNING

This machine is equipped with an accumulator in the brake system. The accumulator stores energy to apply the brakes if the engine stops running. The brake accumulator stores enough energy to apply the brakes five times after the engine stops. When the accumulator pressure is gone, the spring-applied parking brake will engage, and the machine will stop suddenly.

NOTICE

Use caution when towing loads at transport speeds (up to 15 mph). Reduce speed if towed load is not equipped with brakes. Avoid hard braking applications.

NOTE: Never rest a foot on the pedal. Resting a foot on the brake pedal causes unnecessary wear of the brake disks.

Accelerator Pedal



Push pedal (1) down to increase the engine speed. Release the pedal to decrease the engine speed.

Steering Wheel



Turn wheel (1) to the right to steer the machine to the right. Turn the wheel to the left to steer the machine left.

Transmission Control Lever

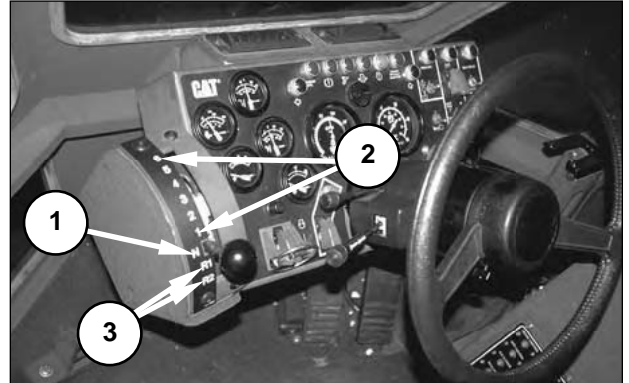

N NEUTRAL (1)—Move the lever into the detent position marked “N” to put the transmission into NEUTRAL.

Forward (2)—Move the lever forward to select one of six forward transmission speeds, marked “1” through “6.”



When the machine is in EARTHMOVING mode, the transmission is limited to three forward speeds. Each speed is manually selected. If the transmission control lever is placed in any position above “3,” the transmission will remain in third gear.

When the machine is in SELF-DEPLOY mode, there are six forward speeds. The transmission will automatically shift between first gear and the maximum gear selected.

R Reverse (3)—Move the lever to the rear to place the transmission into one of two reverse speeds, marked “R1” and “R2.”

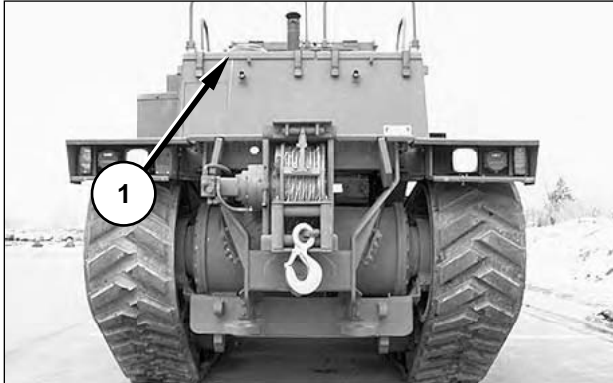
Main Disconnect Switch



-  ON (2)—Turn the switch ON to connect the electrical system to ground.
-  OFF (3)—Turn the switch OFF to disconnect the electrical system from ground.

NOTICE

Never turn the main disconnect switches to OFF with the engine running. Electrical system damage could result.

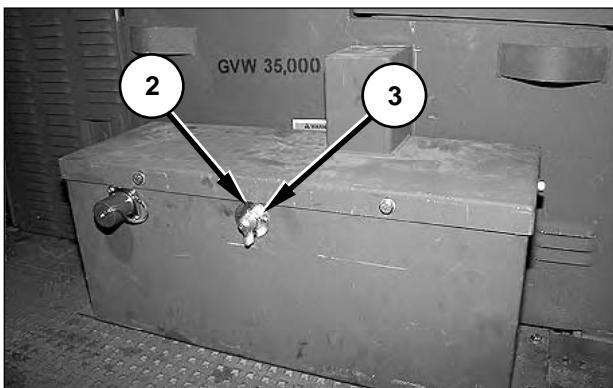
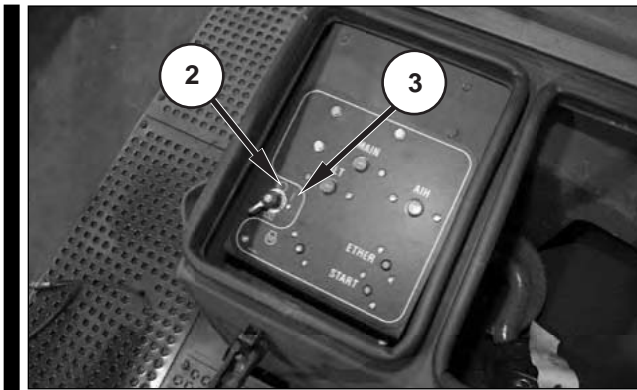

Second Main Disconnect Switch for Optional Arctic Starting System.

The main disconnect switch is located in electrical panel and BII compartment (1) at the rear of the machine. A second disconnect switch is located on the arctic battery box on the left fender, if the machine is equipped with the optional arctic starting system.

NOTE: If the machine is equipped with the optional arctic starting system, both disconnect switches must be in the OFF position to disable the electrical system.

Main Circuit Breakers

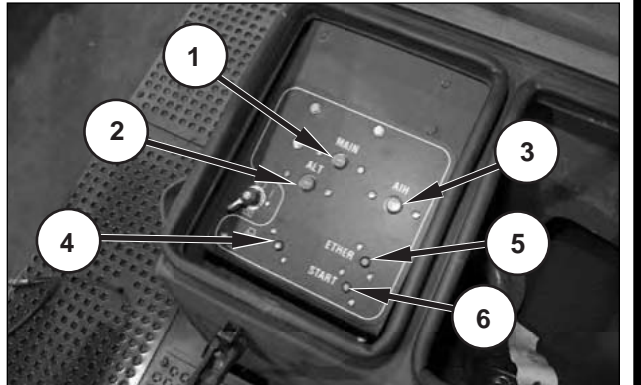

Press the red button to reset the circuit breaker.

- (1) Main—105 Amps
- (2) ALT (Alternator)—105 Amps
- (3) AIH (Intake Air Heater)—80 Amps
- (4)  (Engine Coolant Heater)—30 Amps
- (5) Ether—15 Amps
- (6) Start—10 Amps

NOTE: The main circuit breaker panel is one of two circuit breaker panels on this machine. For the location of the other circuit breaker panel, refer to “Monitoring Systems and Cab Features, Circuit Breakers” in this section.

Auxiliary Start Receptacle (NATO Slave)

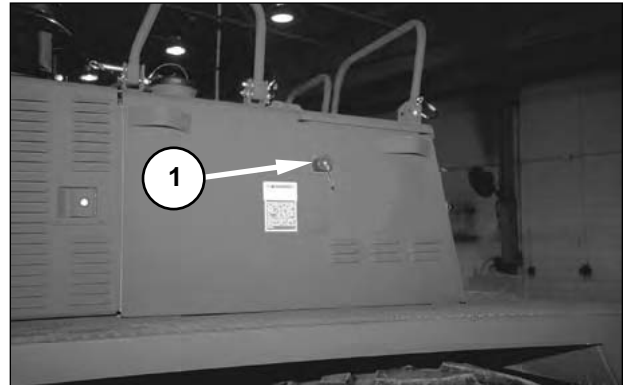

Auxiliary start receptacle (NATO slave) (1) is located at the left rear of the machine.



If the machine is equipped with the optional arctic starting system, auxiliary start receptacle (NATO slave) (1) is located on the arctic battery box on the left fender.

Remote Throttle Switch

WARNING

Do not activate the remote throttle switch when the vehicle is moving. When the remote throttle switch is placed in the ON position, the parking brake is automatically applied, the transmission is placed into NEUTRAL, and the accelerator pedal is disabled.

The remote throttle system holds the engine at a constant high speed for use when operating remote hydraulic tools.

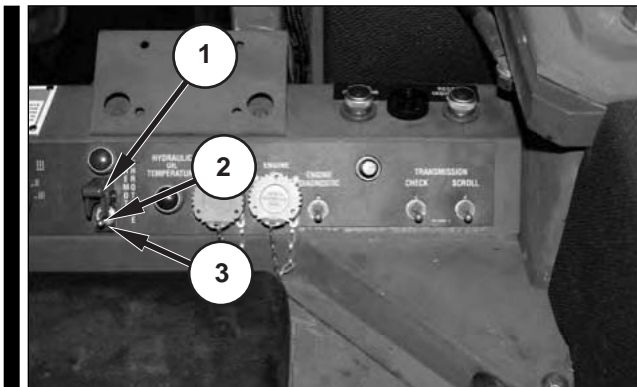

Lift switch cover (1) to access switch.

ON (2)—Move the switch into the ON position (up) to set the engine speed at 2400 rpm.

OFF (3)—Move switch cover (1) down to move the switch into the OFF position.

NOTE: If the remote throttle switch is moved into the OFF position while the transmission control is NOT in NEUTRAL, the transmission will remain in NEUTRAL until the shift lever is cycled back to the NEUTRAL position. If the parking brake switch is in the OFF position when the remote throttle switch is moved to the OFF position, the parking brake will remain ON until the parking brake switch is cycled to the ON and OFF positions.

Kneeling Switch

The kneeling switch lowers the front of the machine for air transport. Refer to “Transportation Information, Preparation for Air Transport (C-130, C-141, C-5)” in this section.

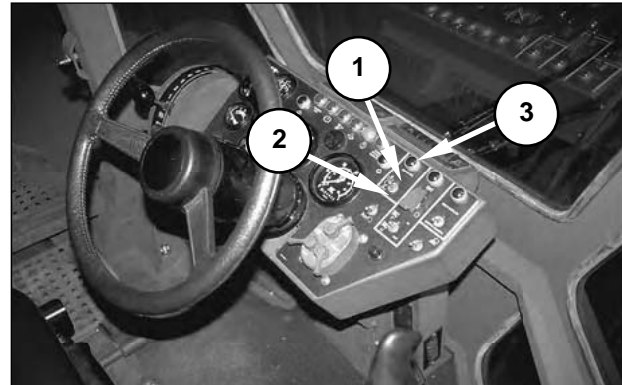

Raise (1)—Hold the switch up in the RAISE position to fully extend the front suspension cylinders and raise the machine.

NOTE: The blackout switch must be in the STOP LIGHT or SERVICE DRIVE position for indicator (3) to function.

NOTICE

The front cylinder locks must be installed to secure the machine in the kneeled position.

Do not operate the machine at speeds greater than 3 kph (2 mph) while it is lowered.

Only operate the machine in the RAISE position, unless in the air transport mode.



Lower (2)—Hold the switch down in the LOWER position to fully retract the front suspension cylinders and lower the machine. Indicator (3) turns on when the machine is fully lowered.

NOTE: The kneeling switch is a three-position toggle switch. The center position of the switch is the OFF position. The switch is spring-centered to the OFF position.

NOTE: The machine will not kneel if it is in the EARTHMOVING mode, or if the manual suspension lock valves are in the LOCK position.

Self-Deploy/Earthmoving Mode Switch

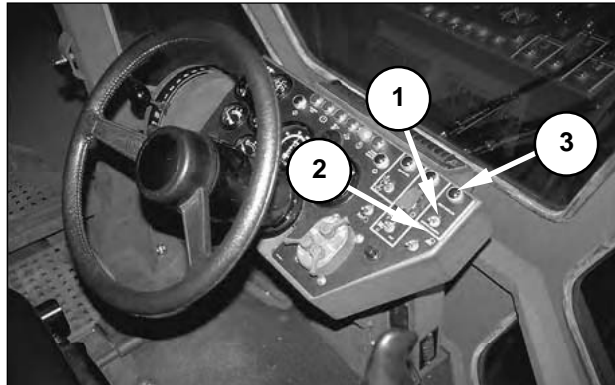

SELF-DEPLOY (1)—Move the switch into the SELF-DEPLOY position (up) to put the machine into SELF-DEPLOY mode.

Indicator (3) turns on when the machine has successfully been put into SELF-DEPLOY mode, if the blackout switch is in the SERVICE DRIVE or STOP LIGHT position.

When the machine is in SELF-DEPLOY mode, the suspension is active to protect the machine from shock loads while travelling at high speed; the blade will operate in all directions except LOWER; and the engine operates at the high horsepower setting.

NOTE: Refer to “Machine Operation, Self-Deploy Mode” in this section for the procedure to put the machine into SELF-DEPLOY mode.

NOTICE

Do not operate on slopes greater than 30 percent (17°) with the machine in SELF-DEPLOY mode. Use only EARTHMOVING mode for slopes greater than 30 percent (17°).

EARTHMOVING (2) – Move the switch into the EARTHMOVING position (down) to put the machine into EARTHMOVING mode.

When the machine is in EARTHMOVING mode, the suspension is deactivated to stabilize the machine for precision blade control, and the engine operates at the low horsepower setting.



NOTE: Refer to “Machine Operation, Earthmoving Mode” in this section for the procedure to put the machine into EARTHMOVING mode.

Winch Control Switches

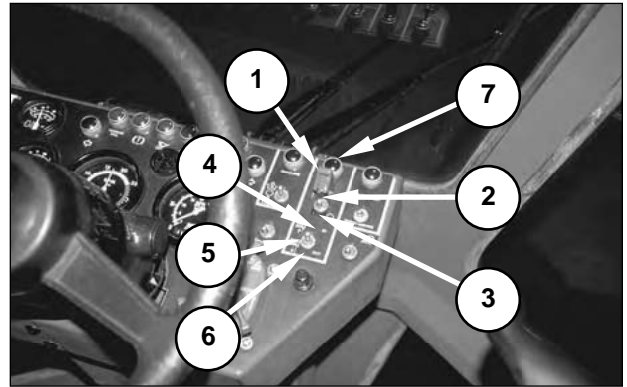
Winch Enable Switch



Lift switch cover (1) to access the switch.

-  **ON (2)**—Move the switch into the ON position (up) to enable the winch control system.
-  **OFF (3)**—Move the switch into the OFF position (down) by closing cover (1), to disable the winch control system.

Indicator (7) turns on when the winch is enabled if the blackout switch is in the SERVICE DRIVE or STOP LIGHT position.

Winch Control Switch

This switch is active when the winch enable switch is in the ON position. The winch clutch must be in the ENGAGED position for the winch to operate (refer to “Operation Section, Equipment Controls, Winch Controls” in this manual).

-  **IN (4)**—Hold the switch in the IN position (up) to operate the winch to reel in the cable.

HOLD (5)—Leave the switch in the center position to stop the winch.

-  **OUT (6)**—Hold the switch in the OUT position (down) to operate the winch to reel out the cable.

Refer to “Winch Operation,” in this manual, for more information on winch functions.

Kneeling Lock Pin

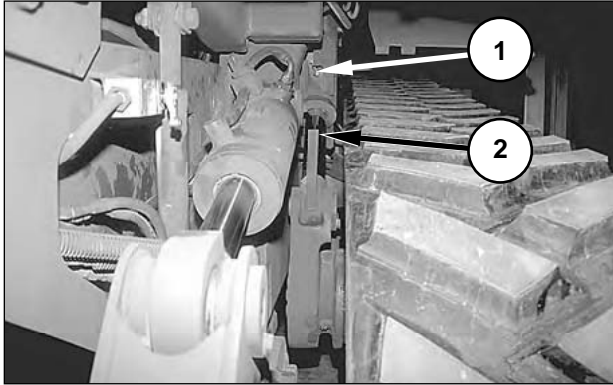

The kneeling lock pin locks the kneeling cylinder in place to ensure that the machine does not drift up after it has been put into the kneeled position. There is a pin on the kneeling cylinder, on each side of the machine.

To lock the kneeling cylinders, remove the pin from bracket (1) on both sides of the machine. When the machine is fully kneeled, insert the pin through bracket (1) and locking bar (2), on both sides of the machine.

NOTE: Use the pump lever to install and remove the pins. The pump lever and kneeling lock pins are normally stored in the BII compartment at the rear of the machine.

NOTICE

The kneeling lock pins should be installed only during air transport. Operating the machine with the kneeling lock pins installed may damage the machine.

Remote Hydraulic Tool Ports

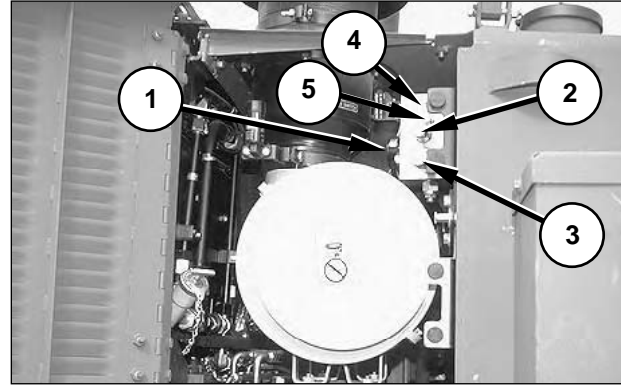

Valve (1) controls the pressure setting in the hydraulic system when the remote hydraulic tools are in use. This valve should be closed (turned clockwise against the stop) during normal machine operation.

NOTICE

The engine may not start if valve (1) is open. Machine performance is adversely effected when the valve is open during normal machine operation.

Ports (2) and (3) supply hydraulic oil to remote hydraulic tools. The ports are located in the air filter compartment, on the left side of the machine.

NOTE: Refer to the operation manual of the hydraulic tool being used for any cautions, notices, or warnings regarding the operation and use of remote tools.

NOTE: Refer to “Machine Operation, Remote Hydraulic Power Manifold” in this section for the procedure to operate the remote hydraulic tool function.

NOTE: Ports (4) and (5) are used for raising the blade and releasing the park brake.

Cab/Radiator Tilt Controls

The cab/radiator tilt controls are used by Unit Maintenance personnel for repairing the machine.

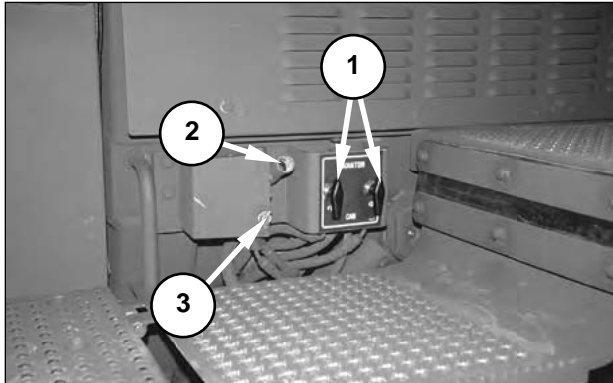

Selector Knobs (1)—When the selector knobs are pointing upwards (turned fully clockwise) the radiator tilt circuit is active. When the selector knobs are pointing downward (turned fully counterclockwise) the cab tilt circuit is active.

Pump Bracket (2)—The pump bracket is used with a lever to raise and lower the cab or radiator.

Direction Selector (3)—The slotted end of the pump lever is used to turn the direction selector. When the direction selector is turned fully counterclockwise, pumping the lever will lower the cab/radiator. When the direction selector is turned fully clockwise, pumping the lever will raise the cab/radiator.

Emergency Drive Belt Tension Adjustment Controls

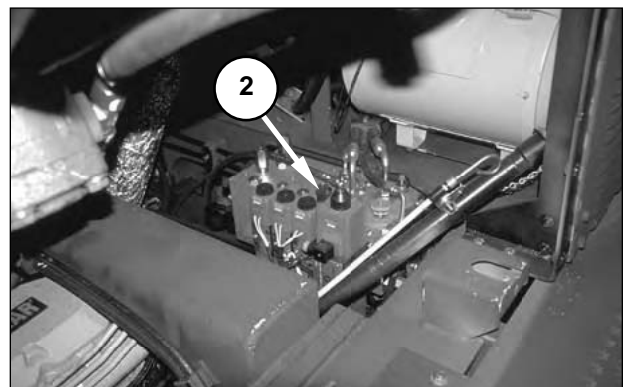
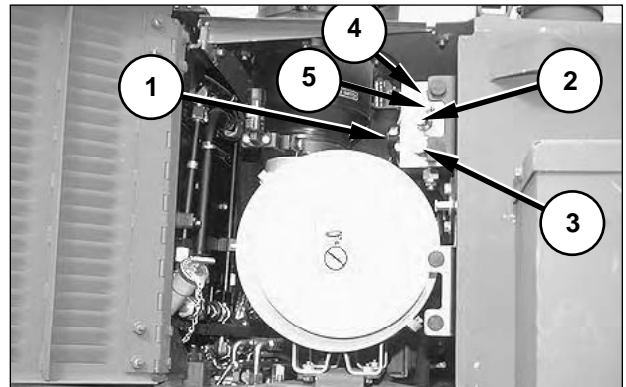

Radiator Shown in Raised Position for Photographic Clarity.

Auxiliary Charge Switch (1) – Move and hold the auxiliary charge switch up to pressurize the drive belt tension adjustment circuit.

Port (2) – The port provides pressurized hydraulic oil to increase the tension of the drive belt.

NOTE: Port (2) can be accessed by raising the radiator (as shown), or through the air filter compartment. For the belt tension procedures, refer to “Machine Operation, Emergency Belt Tension Procedure” in this section.

Suspension Manual Lockout Valves

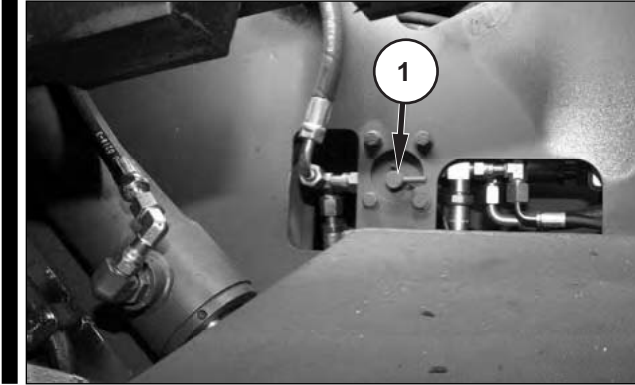

Suspension manual lockout valves (1) are located on both sides of the main frame, in front of the drive wheels. Turn both valves counterclockwise to manually lock the suspension. Turn both valves clockwise to control the suspension using the self-deploy/earthmoving mode switch in the cab.

NOTICE

Do not operate the machine in SELF-DEPLOY mode when the suspension is locked by the manual suspension lockout valves. Damage to the machine may result.

Do not air drop the machine with the manual suspension lockout valves in the LOCK position. Damage to the machine may occur.

Fire Extinguisher Bracket

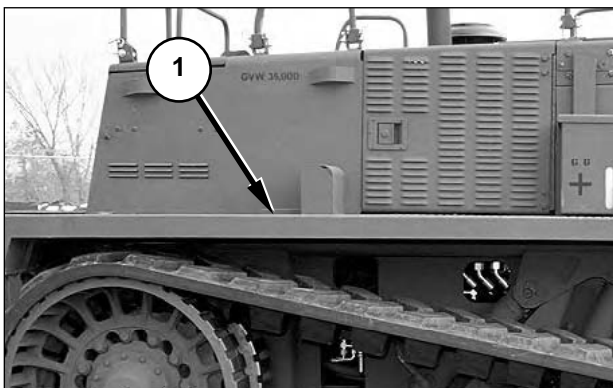

Fire extinguisher bracket (1) is located on the right fender at the rear of the machine.

Decontamination Container Bracket

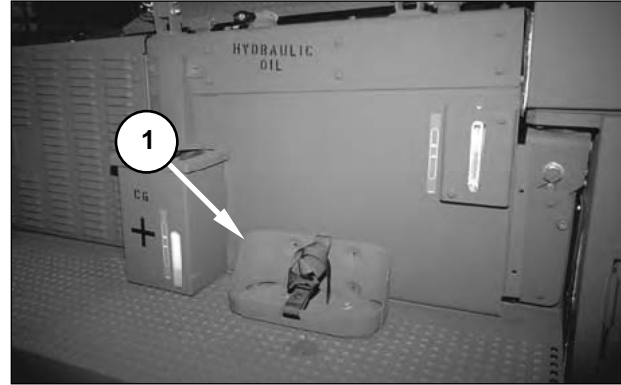

Decontamination container bracket (1) is located on the right side of the machine.

Pintle Hook

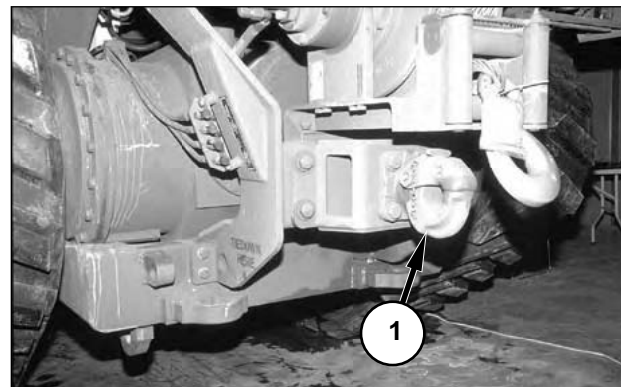

Pintle hook (1) is located at the rear of the machine.

Grab Rails

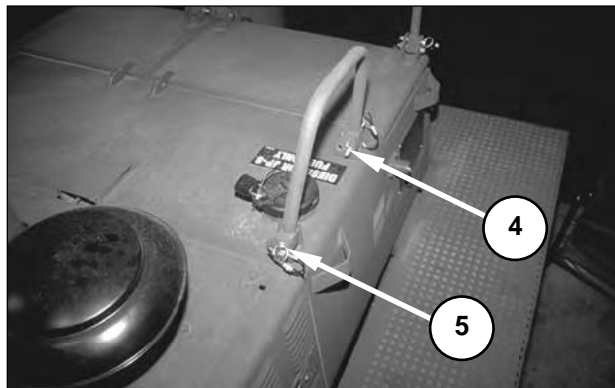
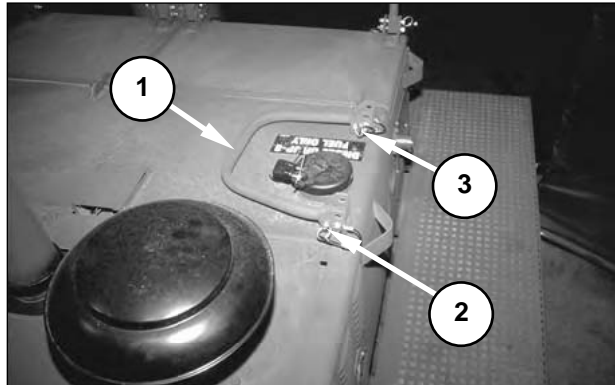

Six grab rails (1) are located around the rear of the machine. The grab rails should be in the up position whenever personnel are standing on the walkways. The grab rails should be in the down position when operating the machine in areas where tree branches and/or brush may damage the rails.

To raise a grab rail, remove locking pins (2 and 3) from the bottom holes, and rotate the rail up. Replace the locking pins in top holes (4 and 5) to lock the grab rail in the up position.

NOTE: The grab rails are pinned so they can be lowered for air transport. In the up position, some movement of the rails may occur.

Engine Coolant Fill Cap

WARNING

At operating temperature, the engine coolant is hot and under pressure. Any contact with the skin can cause severe burns. Also, cooling system additive contains alkalis. Avoid contact with the skin, eyes, and the mouth. Do not open engine coolant fill cap (3) until the temperature of the engine coolant is below 36°C (98°F).

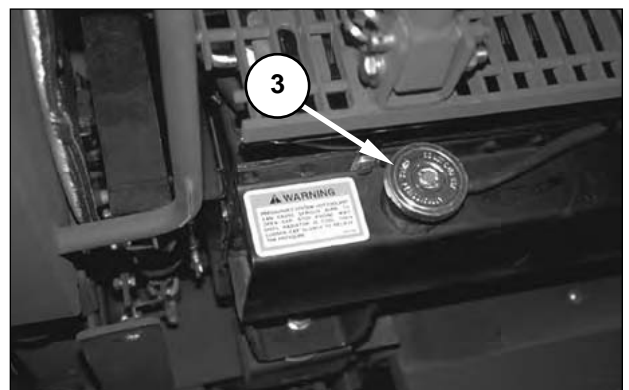
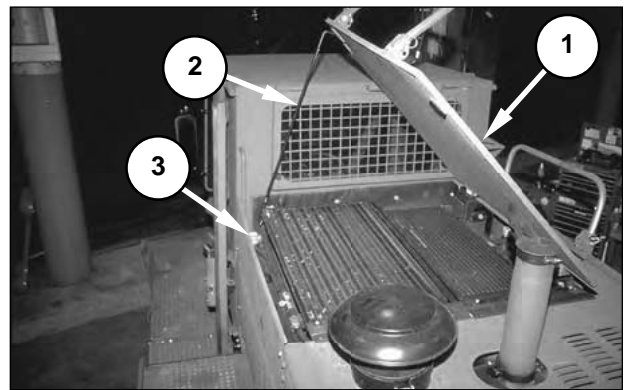

Raise radiator guard (1) to access engine coolant fill cap (3). Place support rod (2) in the prop hole in the radiator guard to secure the guard in the open position.

Turn engine coolant fill cap (3) counterclockwise to remove it. Press in and rotate the cap clockwise to install it.

NOTE: The normal location for checking the coolant level and adding coolant is the coolant overflow bottle. Only add coolant at this location if the coolant overflow bottle is empty or the cooling system has been completely drained.

Fuel Tank Fill Cap

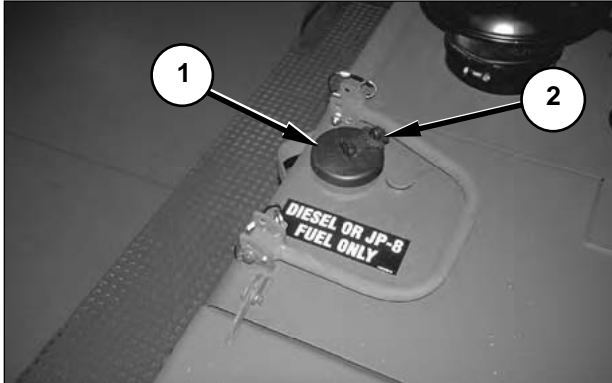

To remove fuel cap (1), raise lever (2) and turn the lever counterclockwise. To install fuel cap (1), install the cap, turn lever (2) clockwise and lower the lever.

Hydraulic Oil Tank Fill Cap

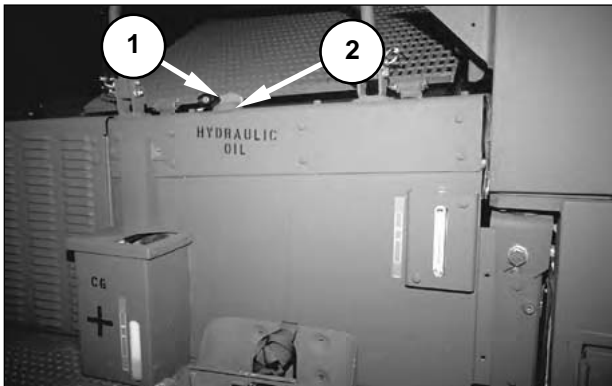

Remove—To remove the hydraulic oil tank fill cap, lift and hold lever (1) while rotating cap (2) counterclockwise.

Install—To install the hydraulic oil tank fill cap, lift and hold lever (1) while rotating cap (2) clockwise.

Power Train Oil Fill Cap

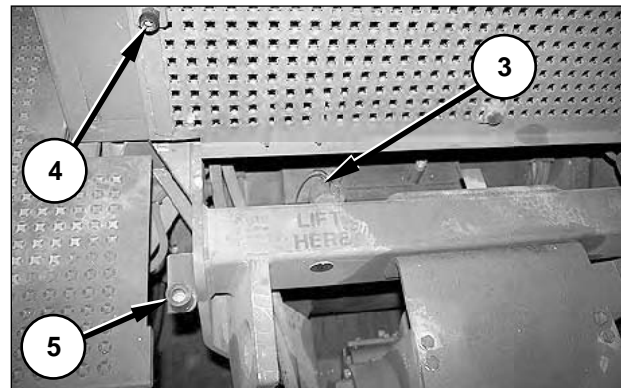
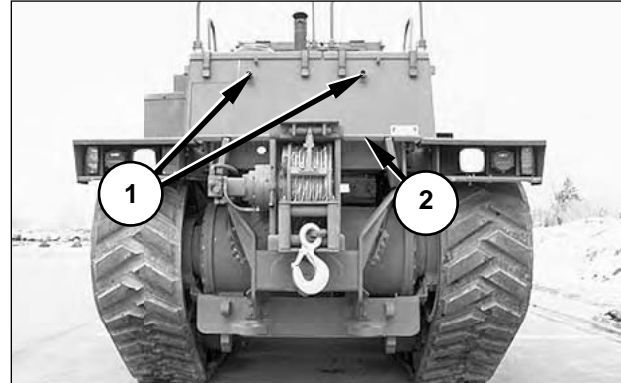

The power train oil fill cap is located under rear walkway (2). Raise the rear walkway and secure the walkway in the up position by inserting the plungers on the walkway into cups (1).

Remove—To remove the power train oil fill cap, rotate cap (3) counterclockwise.

Install—To install the power train oil fill cap, rotate cap (3) clockwise.

Secure rear walkway (1) in the down position by lowering the walkway until plunger (4) inserts in cup (5).

NOTE. Rear walkway (1) is equipped with one plunger (4) and cup (5) on each side.

Electrical Panel and Bll Compartment and Tool and Battery Compartment

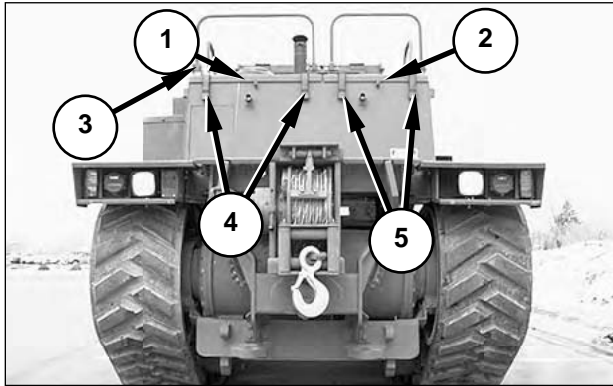

Electrical panel and Bll compartment (1) is the left compartment at the rear of the machine. To gain access to the electrical panel and Bll compartment, lift the bottom of rubber latches (4), and then rotate the top of the rubber latches away from the compartment. Use grab rail (3) to pull the lid towards the rear of the machine, and then raise the lid.

Close electrical panel and Bll compartment (1) by lowering the lid, rotating the top of rubber latches (4) towards the compartment, and then pushing the bottom of the rubber latches towards the compartment. The lid is secure when the top of the rubber latch clamps the lip which is attached to the lid.

Tool and battery compartment (2) is the right compartment, at the rear of the machine. Two rubber latches (5) secure the lid of the compartment. Access to the tool battery compartment can be gained by following the same procedure as described for access to electrical panel and Bll compartment (1).

Emergency Brake Release Valve

NOTE: The emergency brake release valve is used by Unit Maintenance personnel when they tow the machine.

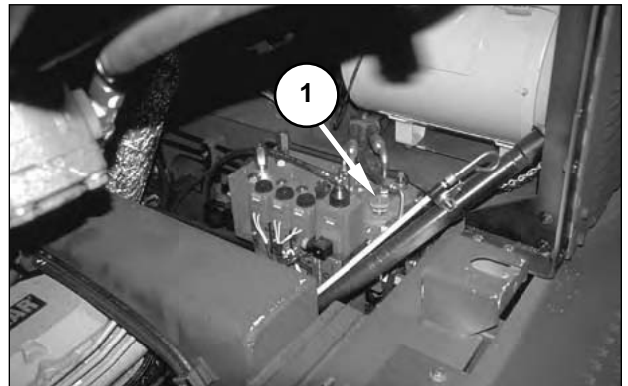

Radiator Shown in Raised Position for Photographic Clarity.

Valve (1) is located on the multifunction valve in the air intake compartment, on the left side of the machine.

Open—Turn valve (1) fully counterclockwise for normal operation.

Closed—Turn valve (1) fully clockwise to prepare the machine for manual parking brake release. When valve (1) is closed, the drain passage from the parking brake is plugged, which allows the manual brake release pump to operate.

Equipment Controls

Blade Controls

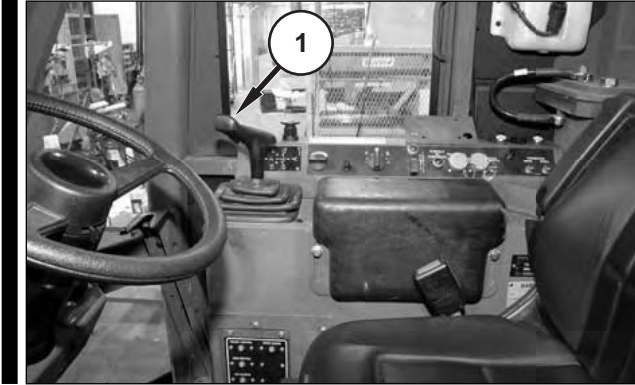

Blade control lever (1) is located on the control console, to the right of the operator.

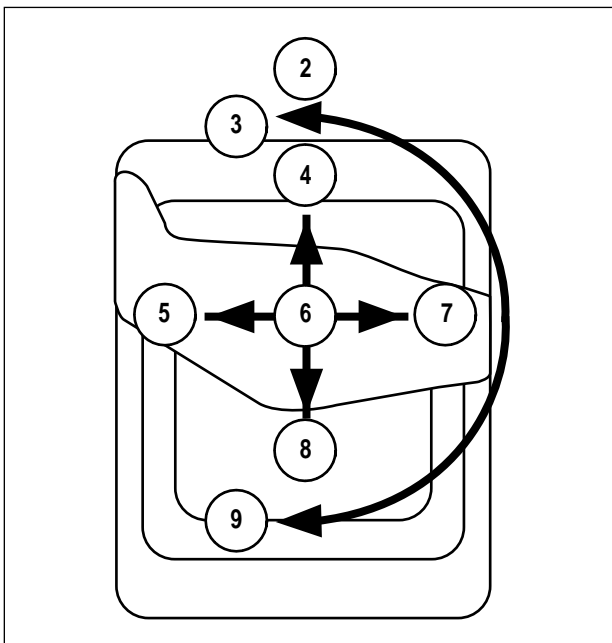

Float (2)—Push the lever all the way forward into the detent position. The blade moves up and down, following the contour of the ground.



Angle Left (3)—Rotate the blade control lever counterclockwise to angle the blade to the left. The lever returns to HOLD when released.



Lower (4)—Move the blade control lever forward to lower the blade. The lever returns to HOLD when released.



Tilt Left (5)—Move the blade control lever to the left to tilt the left corner of the blade down. The lever returns to HOLD when released.



Hold (6)—Return the lever to the center position to stop the blade from moving in any direction.

NOTE: The lever is spring-centered to the HOLD position, when released from all positions except FLOAT.



Tilt Right (7)—Move the blade control lever to the right to tilt the right corner of the blade down. The lever returns to HOLD when released.



Lift (8)—Move the blade control lever to the rear, to lift the blade. The lever returns to HOLD when released.



Angle Right (9)—Rotate the blade control lever clockwise to angle the blade to the right. The lever returns to HOLD when released.

Back Rippers

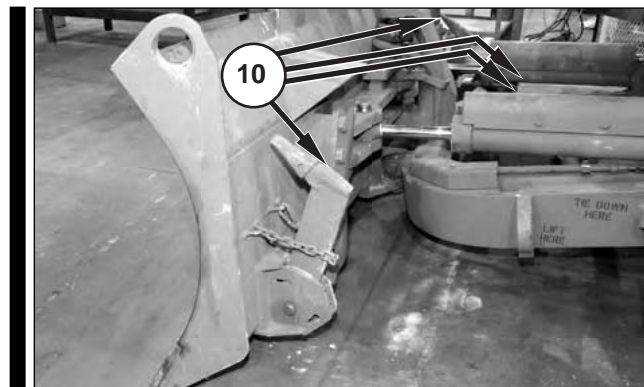

There are four back rippers (10) mounted on the blade and the blade C-frame. Use the blade control lever to position the rippers while ripping.

Winch Controls

Winch Clutch

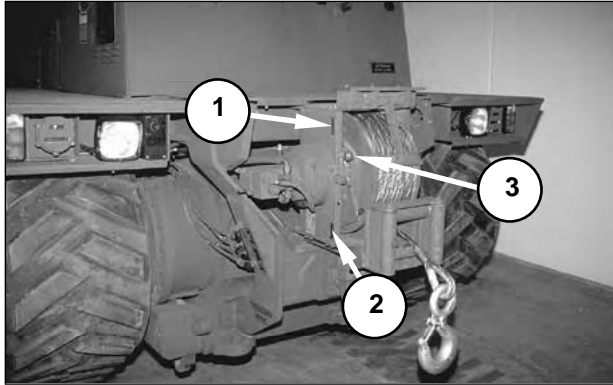

WARNING

Do not move the winch clutch lever to the DISENGAGED position with a load on the line. The load is released uncontrolled and can result in personal injury or death.

Disengaged (1)—To disengage the winch, pull knob (1) on the clutch lever out, and rotate the lever to the DISENGAGED position. Release the knob so the peg inserts in the hole in the winch frame.

Engaged (2)—To engage the winch, pull knob (3) on the clutch lever out, and rotate the lever to the ENGAGED position. Release the knob so the peg inserts in the hole in the winch frame.

NOTE: It may be necessary to momentarily operate the winch in or out to allow the winch clutch to engage smoothly.

NOTICE

Do not force the winch clutch lever into position. Damage to the winch may result if the lever is forced.

Before Starting the Engine

WARNING

Diesel engine exhaust contains products of combustion which may be harmful to your health. Always start and operate the engine in a well ventilated area and, if in an enclosed area, vent the exhaust to the outside.

Machine Prestart Checks



For maximum service life of the machine, make a thorough walk-around inspection before mounting the machine to start the engine. Refer to “Every 10 Service Hours or Daily, Walk-around Inspection” in this manual for the procedure.

Turn the main disconnect switch ON. Refer to “Machine Features, Main Disconnect Switch” in this section for the procedure.

Army operators should perform the Operator’s Preventative Maintenance Checks and Services (OPMCS) in Appendix A.

Seat and Seat Belt Checks

NOTE: Adjust the seat at the beginning of each shift, or when changing operators.

Adjust the seat to allow for full travel of the pedals when the operator is seated against the seat back.

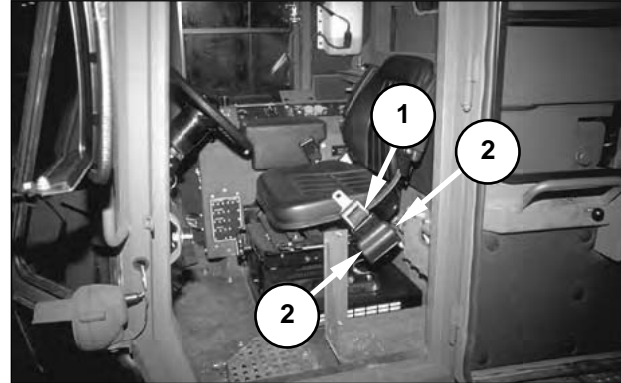

Inspect seat belt mounting hardware (2). Replace any damaged or worn hardware. Keep the mounting bolts tight.

Fasten seat belt (1) before starting the engine.

Gauges



Inspect all gauges on instrument panel (1). Have Unit Maintenance repair any unreadable gauges.

Engine Starting

! WARNING

Never idle the engine in a closed area. Exhaust gases, particularly carbon monoxide, may build up. These gases are harmful and potentially lethal.

! WARNING

With the engine running, this machine will spot turn when the steering wheel is turned, even if the transmission is in NEUTRAL.

To avoid personal injury due to unexpected movement, engage the parking brake and make sure the area is free of personnel before starting the engine.

NOTICE

Never push or tow the machine to start the engine. Doing so can damage the drive train.

Engine Starting Above 0°C (32°F)

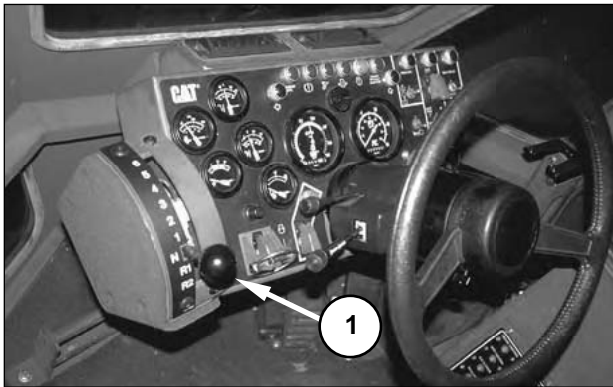

1. Move transmission control lever (1) into NEUTRAL.

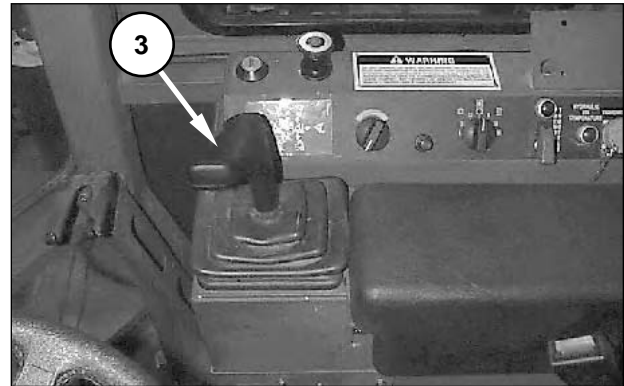

3. Move blade control lever (3) to the HOLD position.

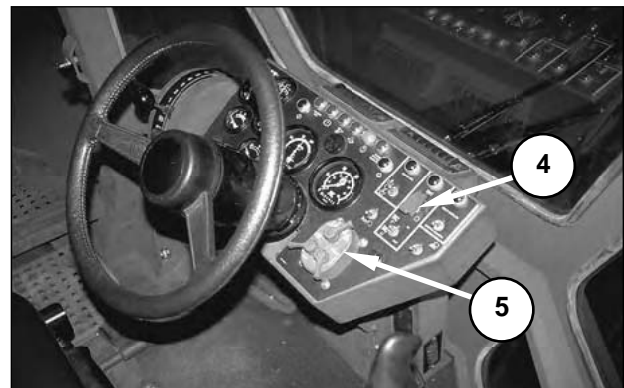

4. Close cover (4) on the winch enable switch to move the switch into the OFF position.

5. Move blackout light switch (5) into the desired operating position.

NOTE: The indicator check is only fully functional while the blackout switch is in the SERVICE DRIVE or STOP LIGHT position.



2. Pull up on knob (2) to engage the parking brake.

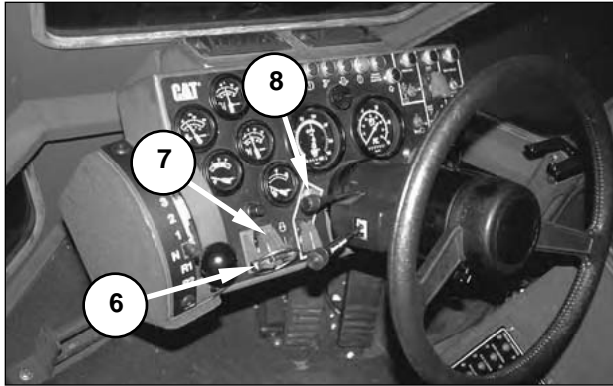

6. Remove locking pin (6) and lift cover (7) on the start switch.

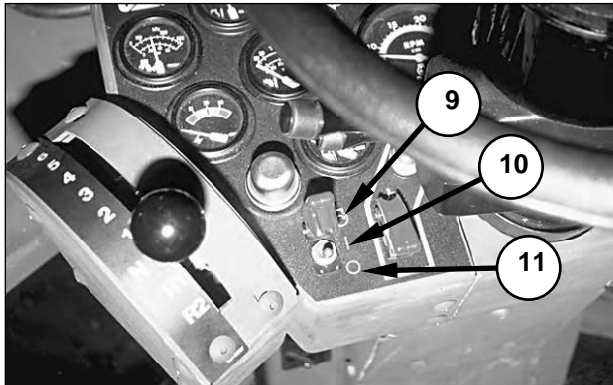

7. Move the start switch from OFF position (11) to ON position (10). If start-aid indicator (8) comes on, wait until the indicator turns off (up to 30 seconds) before attempting to start the engine.
8. Move the start switch to START position (9). Hold the switch in START, and engage the blade control lever at the same time to crank the engine. The indicators will turn on to indicate the presence of any burned out bulbs. (Refer to "Operation Section, Monitoring Systems and Cab Features, Blackout Light Switch," in this manual for a list of indicators which operate in the different blackout switch positions.) Release the engine start switch when the engine starts.

NOTE: Do not push or hold the accelerator pedal down while cranking the engine. The ECM will automatically provide the correct amount of fuel to start the engine.

NOTE: The combined action of holding the START switch and engaging the blade control lever simultaneously provides for easier starting and less strain on the implement pump.

9. If the engine does not start after 15 to 30 seconds of cranking, release the engine start switch and move it to ON position (10) to allow the air inlet heater to operate. Wait approximately 30 seconds to allow the starting motor to cool before operating the starter again. Repeat Steps 7 and 8.

NOTICE

Do not keep the starting motor engaged for more than 30 seconds at a time. Wait 30 seconds to allow the starting motor to cool before trying again. If the engine does not start after three attempts, determine the cause of the malfunction. Pumping the accelerator pedal will not assist in starting the engine.

Do not increase engine speed until the oil pressure gauge indicates between 250 and 450 kPa (30 and 70 psi). Oil pressure should raise within 15 seconds after the engine starts. If oil pressure is not indicated on the gauge within 15 seconds, do not drive the machine. STOP the engine, and report the problem to Unit Maintenance. Do not operate the machine until the problem has been corrected.

NOTE: Applying a light load will help the engine reach normal operating temperature sooner. When idling in cool weather, the ECM may increase the engine speed to approximately 1000 to 1200 rpm. Do not race the engine to make the machine warm up more quickly.

NOTE: The ECM will disengage the starter at 600 rpm. Holding the starter engaged after the engine has started will not damage the starter.

Engine Starting Between 0°C and -32°C (32°F and -25°F)

! WARNING

DO NOT SPRAY ETHER (starting fluids) into the air intake. This diesel engine is equipped with an electric air intake heater system to aid cold weather starting and reduce white smoke. Do not spray ether into the air inlet. It will contact the heater elements. Use ONLY the start-aid system or immediate engine damage and personal injury may result.

NOTICE

Inject starting aid (ether) only after initial start-up, until the engine is running smoothly.

Wait approximately three seconds before each ether injection.

Use ether for cold starting purposes only, as directed.

Use ether sparingly. Excessive ether without cranking can cause piston and ring damage.

1. Follow Steps 1 through 7 of "Engine Starting Above 0°C (32°F)," in this section.

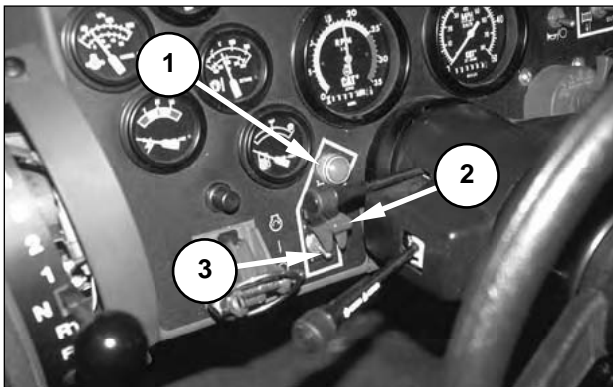

2. If start-aid indicator (1) comes on, wait until the indicator turns off (approximately 30 seconds) before attempting to start the engine.
3. When start-aid indicator (1) has turned off, hold the engine START switch and engage the blade control lever at the same time to crank the engine.

NOTE: The combined action of holding the START switch and engaging the blade control lever simultaneously provides for easier starting and less strain on the implement pump.

4. If the engine does not start after 15 to 30 seconds of cranking, release the engine start switch and move it to the ON position to allow the intake air heater to operate. Wait approximately 30 seconds to allow the starting motor to cool and intake air to heat before cranking the engine again. Repeat Steps 2 through 4 until the engine starts.

NOTE: Do not use ether to help start the engine at temperatures above -32°C (-25°F). At warmer temperatures, ether reduces the amount of oxygen available for combustion, which makes the engine more difficult to start.

NOTICE

Do not keep the starting motor engaged for more than 60 seconds at a time. Wait 30 seconds to allow the starting motor to cool and inlet air to heat before trying again. Pumping the accelerator pedal will not assist in starting the engine.

5. Release the engine start switch into the ON position after the engine reaches 1000 rpm. If the engine runs roughly, operate start-aid switch (3) manually to inject ether sparingly until the engine is running smoothly.

NOTE: The ECM will disengage the starter at 600 rpm. Holding the starter engaged after the engine has started will not damage the starter.

NOTICE

Do not increase engine speed until the oil pressure gauge indicates normal. The engine oil pressure indicator should go off, and the oil pressure should raise within 15 seconds after the engine starts. If oil pressure is not indicated on the gauge within 15 seconds, do not drive the machine. stop the engine, and report the problem to Unit Maintenance. Do not operate the machine until the problem has been corrected.

NOTE: Applying a light load will help the engine reach normal operating temperature sooner. When idling in cold weather, the ECM will increase the engine speed to approximately 1000 to 1200 rpm. Do not race the engine to speed warm-up.

Engine Starting Below -32°C (-25°F)**! WARNING**

Do not spray ether (starting fluids) into the air intake. This diesel engine is equipped with an electric air intake heater system to aid cold weather starting and reduce white smoke. Do not spray ether into the air inlet. It will contact the heater elements. Use only the start-aid system or immediate engine damage and personal injury may result.

! WARNING

Do not operate the engine coolant heater in an enclosed area. The heater produces combustion gases which may be harmful to your health. Always start and operate the heater in a well-ventilated area and, if in an enclosed area, vent the exhaust to the outside.



1. Press switch (1) to start the engine coolant heater. An indicator in the switch illuminates when the engine coolant heater is ON. Allow the engine coolant heater to operate for 40 minutes.
2. Press switch (1) to shut the engine coolant heater off. Wait for three minutes before attempting to start the engine.

NOTICE

Do not start the engine for three minutes after using the engine coolant heater. The engine coolant heater requires three minutes to complete the shutdown cycle. Damage to the engine coolant heater may result if the engine is started without a three-minute wait to purge the system.

3. Follow Steps 1 and 2 of "Engine Starting Between 0°C and -32°C (32°F and -25°F)" in this section.
4. Hold the engine start switch and engage the blade control lever at the same time to crank the engine.
5. After five to ten seconds of cranking, inject ether by pressing and holding the start-aid switch for three seconds, and then releasing it. Repeat the injection of ether every 10 to 15 seconds while cranking the engine.

NOTICE

Do not keep the starting motor engaged for more than 90 seconds at a time. Wait one minute to allow the starting motor to cool before trying to start the engine again. Pumping the accelerator pedal will not assist in starting the engine.

6. Release the engine start switch into the ON position after the engine reaches 1000 rpm. If the engine runs roughly, operate the start-aid switch manually to inject ether sparingly until the engine is running smoothly.

NOTE: The ECM will disengage the starter at 600 rpm. Holding the starter engaged after the engine has started will not damage the starter.

NOTICE

Do not increase engine speed until the oil pressure gauge indicates normal. The engine oil pressure indicator should go off, and the oil pressure should raise within 15 seconds after the engine starts. If oil pressure is not indicated on the gauge within 15 seconds, do not drive the machine. Stop the engine, and report the problem to Unit Maintenance. Do not operate the machine until the problem has been corrected.

NOTE: Applying a light load will help the engine reach normal operating temperature sooner. When idling in cold weather, the ECM may increase the engine speed to approximately 1000 to 1200 rpm. Do not race the engine to speed warm-up.

Engine Starting with Auxiliary Start (NATO Slave) Receptacle

WARNING

Jump only with a 24-volt battery source.

Turn off all lights and accessories on the stalled machine. Otherwise, the lights and accessories operate when the jump source is connected.

When starting from another machine, make sure the machines do not touch to prevent damage to engine bearings and electrical circuits.

Severely discharged maintenance-free batteries do not fully recharge from the alternator alone after jump starting. The batteries must be charged to the proper voltage with a battery charger. Many batteries thought to be unusable are still rechargeable.

NOTICE

This machine has a 24-volt starting system. Use only equal voltage for jump starting. Use of a higher voltage will damage the electrical system.

1. Refer to “Troubleshooting, Operational Troubleshooting, 1. Starter Fails to Crank When Start Switch Is Held in START Position” in this section to find the reason that the stalled machine failed to crank. Correct any detectable problems. If the cause cannot be determined, continue with this procedure to jump-start the machine. Report the problem to Unit Maintenance for repair.

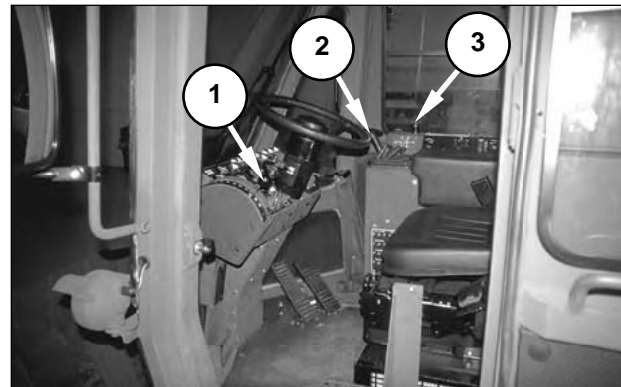

2. Place transmission control lever (1) into NEUTRAL on the stalled machine.
3. Pull knob (3) up to engage the parking brake on the stalled machine.
4. Move blade control lever (2) into the LOWER position on the stalled machine. Move the blade control lever to the HOLD position when the blade is resting on the ground.



5. Move the start switch into OFF position (4) on the stalled machine. Turn off all electrical accessories (lights, winch, fans, radios, wipers).

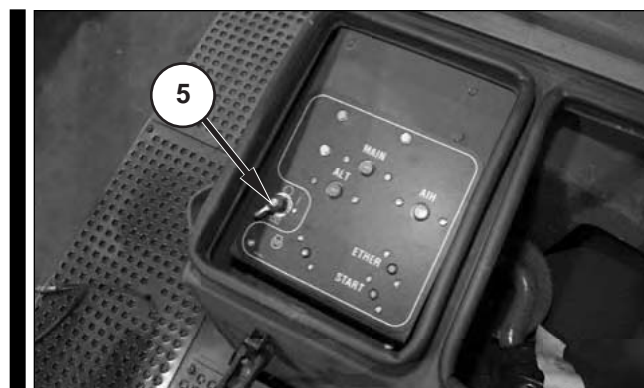

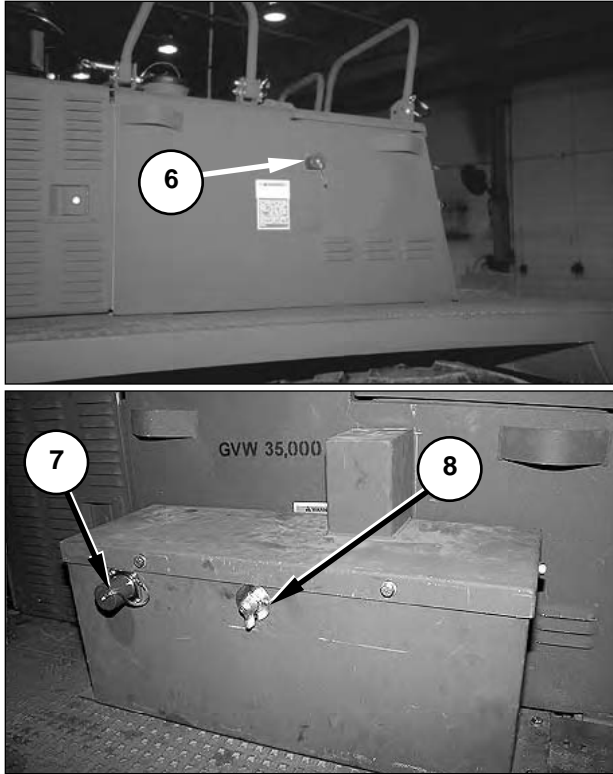

Optional Arctic Batteries.

11. Start the engine on the boost machine, or activate the charging system on the auxiliary power source.
12. Wait a minimum of two minutes for the batteries of the stalled machine to partially charge.
13. Attempt to start the stalled engine. Refer to the beginning of "Engine Starting," in this section.
14. Immediately after starting the stalled engine, disconnect the NATO slave cable from the BOOST SOURCE.
15. Disconnect the other end of the cable from the stalled machine.

6. Make sure that main disconnect switches (5) and (8, if equipped) are in the ON position on the stalled machine.
7. Move the boost-start machine near enough to the stalled machine for the cables to reach, but DO NOT ALLOW THE MACHINES TO TOUCH.

NOTICE

Do not allow the machines to touch while jump starting the machine. Damage to the boost-start machine or stalled machine may result.

8. Stop the engine on the boost machine, or, if using an auxiliary power source, turn off the charging system.
9. On the stalled machine, connect the NATO slave cable to the auxiliary start receptacle (NATO slave) (6) or (7, if equipped).
10. Connect the other end of this cable to the auxiliary start receptacle (NATO slave) of the boost source.

After Starting Engine

NOTICE

Keep the engine speed low until the engine oil pressure indicator turns off and the gauge indicates normal. If the light does not go out within 15 seconds, stop the engine and inform Unit Maintenance of the problem. Do not operate the machine until the cause of the problem has been corrected. Operating the machine when the engine oil pressure indicator is illuminated can result in engine damage. The engine oil pressure indicator illuminates when the engine oil pressure is 35 ± 21 kPa (5 ± 3 psi).

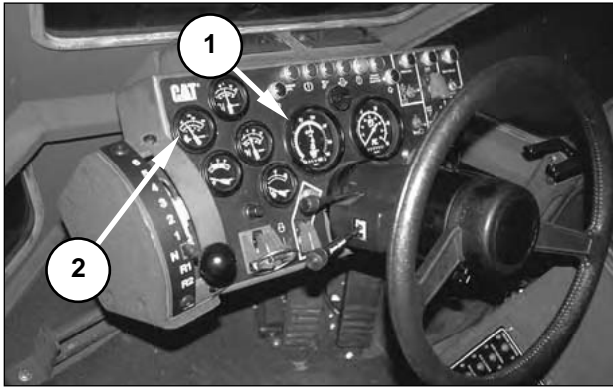

1. Gradually depress the accelerator pedal until tachometer (1) indicates that the engine speed is 1200 rpm.
2. When engine oil pressure gauge (2) indicates that the engine oil pressure is above approximately 240 kPa (35 psi), release the accelerator pedal.
3. Put the machine into EARTHMOVING mode. Refer to "Machine Operation, Earthmoving Mode" in this section.

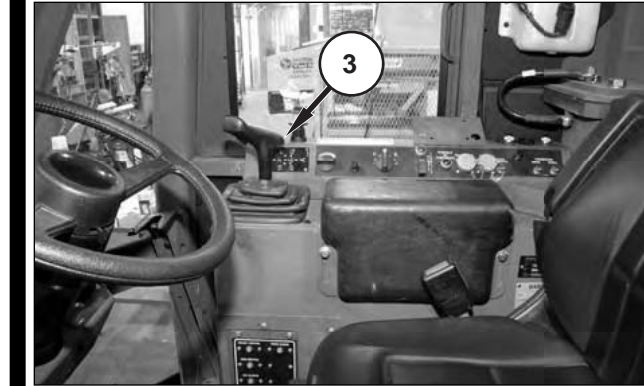

4. Allow the engine to warm up at LOW IDLE for five minutes. During the warm-up period, use blade control lever (3) to RAISE and LOWER the blade, in order to help speed the warm up of the hydraulic components.
5. Observe the gauges and indicators frequently during operation.

Machine Operation

WARNING

To minimize whole body vibration, based on 24 hour operations, limit daily machine usage to a maximum of 11.5 hours, no more than 4 hours continuous; the operator must rest between operations at least 4.16 hours. Failure to comply may result in injury.

Earthmoving Mode

Put the machine in EARTHMOVING mode when using the machine for dozing, or ripping. EARTHMOVING mode may also be used for winching. When the machine is in EARTHMOVING mode:

- the suspension is locked in forward, and active in reverse.
- the transmission is limited to three speeds forward, with manual shifting.
- the engine is limited to the low horsepower setting.

To Place the Machine in EARTHMOVING Mode



1. Stop the machine and place transmission control lever (1) into NEUTRAL.



2. Move the self-deploy/earthmoving switch to EARTHMOVING position (2).

Manual Suspension Locking

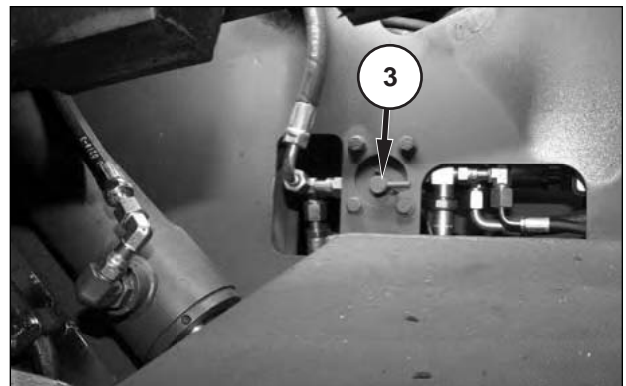

Valves are installed on the machine to manually lock the suspension into EARTHMOVING mode. These valves provide a way to lock the suspension if the electrically operated solenoids do not function.

LOCK—Turn manual suspension lockout valves (3) (on both sides of the machine) counterclockwise to manually lock the suspension into EARTHMOVING mode.

NOTICE

Do not operate the machine in SELF-DEPLOY mode when the suspension is locked by the manual suspension locking valves. Damage to the machine may result.

UNLOCK—Turn manual suspension lockout valves (3), on both sides of the machine, clockwise to return control of the suspension locking function to the self-deploy/earthmoving switch.

Self-Deploy Mode

Put the machine into SELF-DEPLOY mode to travel at high speeds. When the machine is in SELF-DEPLOY mode:

- the suspension is active.
- the transmission will automatically shift between six speeds in forward.
- the blade can be raised, angled or tilted, but not lowered.

WARNING

The blade can be lowered when the machine is in SELF-DEPLOY mode if the electrical power to the machine is off. Always keep clear of the blade when the blade is off the ground. Personal injury can occur.

- the engine operates at the high horsepower setting in transmission speeds three through six.
- the SELF-DEPLOY indicator is lit.

To Place the Machine in SELF-DEPLOY Mode

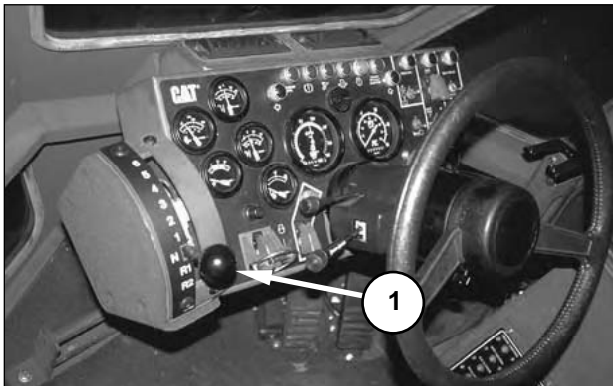

1. Stop the machine and place transmission control lever (1) into NEUTRAL.

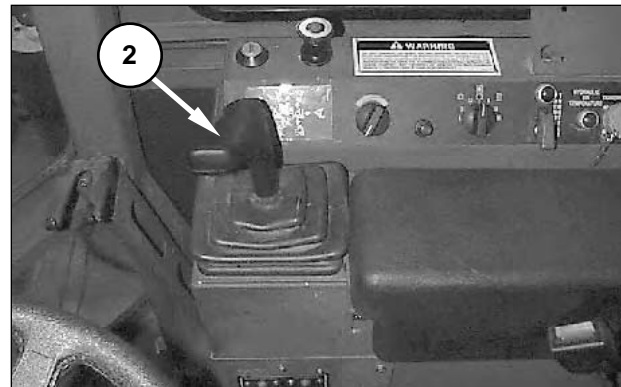

2. Move blade control lever (2) to LIFT, and raise the blade all the way up.

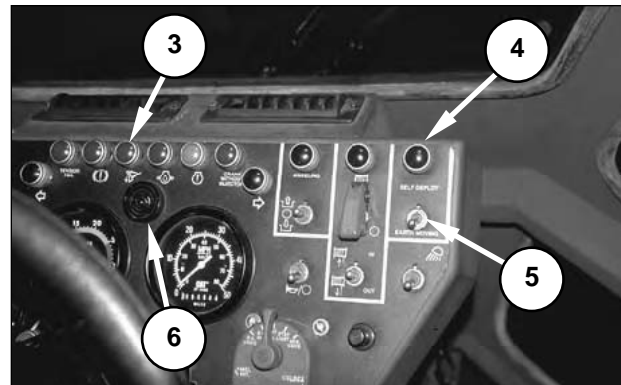

3. Move self-deploy/earthmoving switch (5) into SELF-DEPLOY position. Self-deploy indicator (4) will turn on. If the self-deploy indicator does not come on, raise the blade further until blade down indicator (3) and blade down alarm (6) turn off.

NOTE: Self-deploy indicator (4) will only function if the blackout light switch is in the SERVICE DRIVE or STOP LIGHT position.

NOTE: Blade down indicator (3) and blade down alarm (6) will only function if the blackout light switch is in the SERVICE DRIVE or STOP LIGHT position.

Winch Operation

WARNING

Make sure personnel are clear of wire rope cable when there is a load on it. The cable can break and cause personal injury or death.

WARNING

Thick gloves should be worn when working with cable. Failure to do so may cause severe injury to hands and fingers.

WARNING

Keep away from the winch fairlead when the cable is retracting. Personal injury due to pinching at the fairlead is possible when the winch cable is retracting.

NOTICE

Always operate the winch with the cable in as straight a line as possible. For winching operation other than self-recovery, always operate the winch with the tractor in a stationary position. Moving the tractor while operating the winch may damage the winch.

Refer to “Machine Features, Winch Control Switches” in this section for an explanation of the winch control switches, and “Equipment Controls, Winch Controls” in this section for explanation of the winch clutch.

The winch can be operated with the machine in either EARTHMOVING or SELF-DEPLOY modes. Use the engine accelerator pedal to control the winch speed.

The rear window screen must be down when the winch is operated.

The last five wraps of cable must be left on the drum to assist the cable clamp in holding the load.

The winch has a maximum pulling capacity of 97 856 N (22,000 lb). For loads greater than 97 856 N (22,000 lb), use the doubling block which is stored in the BII compartment (left compartment at the rear of the machine). When the doubling block is used, the maximum pulling force from the doubling block hook is 195 712 N (44,000 lb).

NOTICE

The of the doubling block must be used when performing self-rescue of the machine. The winch should not be used to tow another DEUCE.

Doubling Block Installation

NOTE: The weight of the doubling block is **23 kg (51 lb)**.

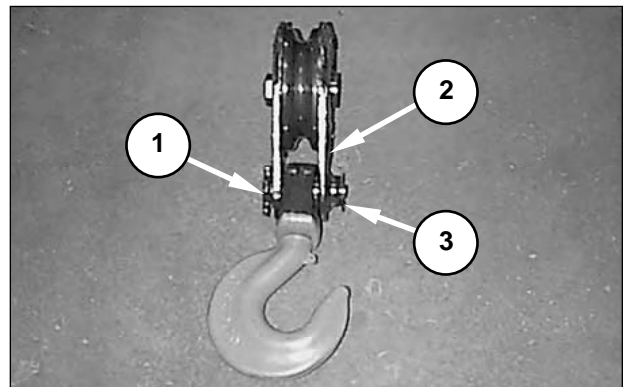

1. Remove cotter pin (3).
2. Turn pin (1) counterclockwise until the end of the pin clears side plate (2).

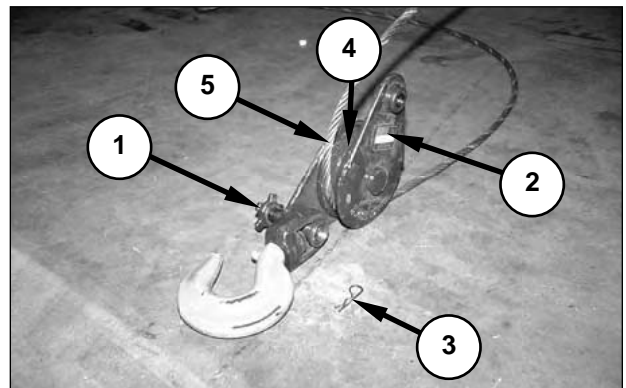

3. Rotate side plate (2) to allow access to sheave (4).
4. Run winch cable (5) around the sheave. Refer to “Equipment Controls, Winch Controls” in this section for explanation of the winch clutch.
5. Return side plate (2) to its original position, and reinstall pin (1) and cotter pin (3).

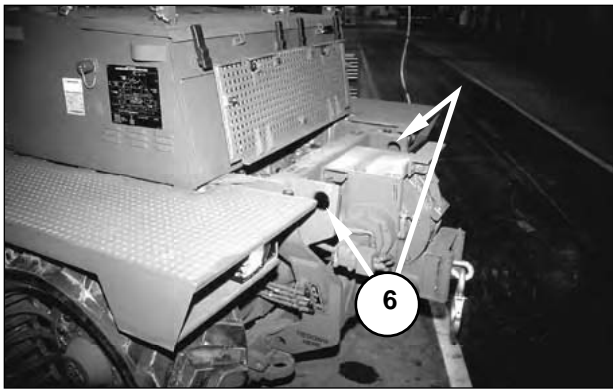

6. Attach the hook on the end of the winch cable to the lifting eye (6) on either side of the winch.

! WARNING

When attaching hook for winching operations, position the throat (open part) of hook upward in case overloading straightens the hook. Failure to do this may result in injury or death of personnel.

7. Attach the hook on the doubling block to the load, and operate the winch to haul the load in. Refer to "Machine Features, Winch Control Switches," in this section.

Remote Hydraulic Power Manifold

Preparation for Use of Remote Hydraulic Tools

! WARNING

Refer to operation and maintenance information for any tool to be used with the remote hydraulic power manifold. Army personnel should refer to TM 5-2420-224-10.

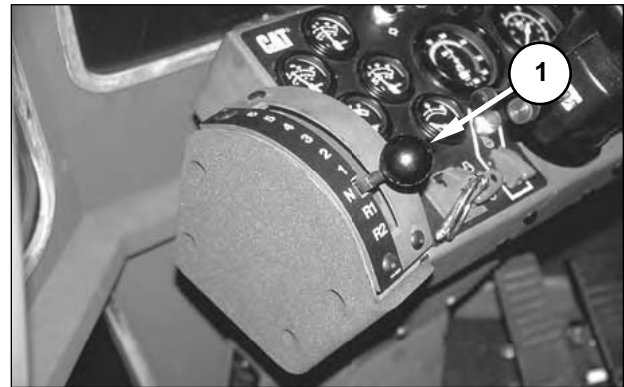

1. Start the engine. Refer to "Engine Starting" in this section. Leave transmission control lever (1) in NEUTRAL.

NOTE: The machine must be in the EARTHMOVING mode to lower the blade. Refer to "Machine Operation, Earthmoving Mode" in this section for the procedure to place the machine in the EARTHMOVING mode.

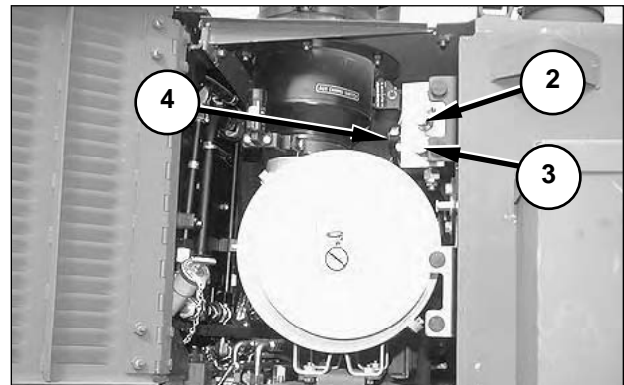

2. Install the remote tool supply line to fitting (2), located in the engine air intake compartment.
3. Install the remote tool return line to fitting (3).

4. Open the needle valve by turning knob (4) counterclockwise.

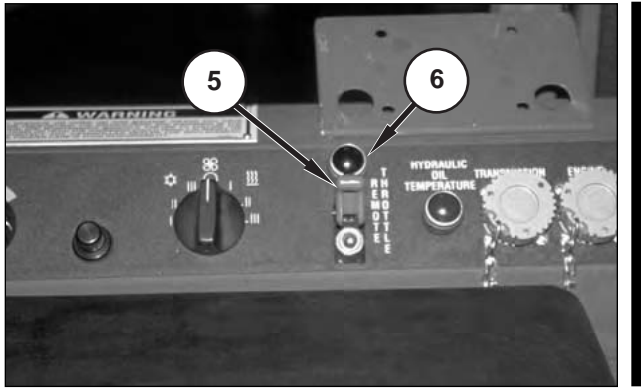

5. Lift switch cover (5) and move the remote throttle switch to ON (up).

NOTE: Remote throttle indicator (6) will illuminate if the blackout switch is in STOP LIGHT or SERVICE DRIVE; engine speed will increase to 2400 rpm; the parking brake will remain engaged, regardless of the position of knob (3); the accelerator pedal will not function; and the transmission will remain in NEUTRAL, regardless of the position of transmission control lever (1).

6. Use the remote tools in accordance with the manufacturer's recommendations.

NOTE: Refer to the operating instructions of the remote hydraulic tool in use for safety precautions and correct operating instructions.

Returning Machine to Normal Operation

1. Move the remote throttle switch into the OFF position, and close switch cover (7).
2. Close the needle valve by turning knob (6) clockwise, until tight.

NOTICE

Failure to close the needle valve will cause the machine hydraulic system to not operate within specifications.

3. Disconnect the remote tool supply line and remote tool return line from fittings (4) and (5).

Back Rippers

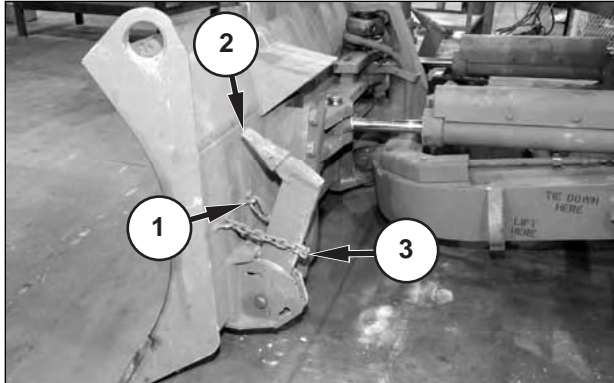

To lower the back rippers for use, remove chain (3) while holding ripper (2). Allow the ripper to rest on the ground and secure chain to ring (1).

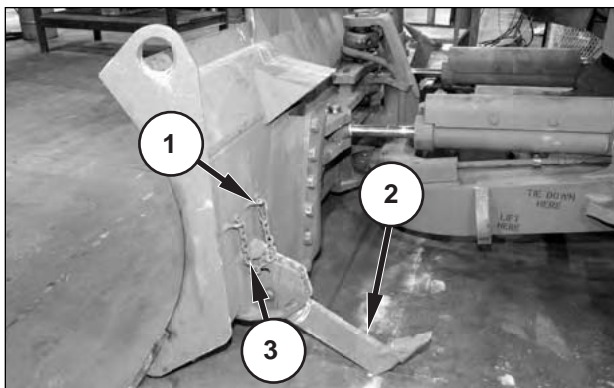

To raise the back rippers for storage, lift back ripper (2), and hold in place, while securing chain (3), to ring (1).

Emergency Suspension Charging and Emergency Drive Belt Tension Procedure

WARNING

The hydraulic system operates at high pressure. Wear eye and face protection, gloves and protective clothing when performing this procedure. Failure to comply may result in severe injury or death.

NOTICE

This procedure is for emergency field use, to mobilize the machine if either of the drive belts become loose. If this procedure is performed for any reason, deliver the machine to Unit Maintenance to have the suspension properly charged before returning the machine to normal service. Do not overcharge the cylinders.

Suspension Hydraulic Charge Specifications

Description	Minimum Charge With Machine On Ground in kPa (psi)
Middle Suspension Cylinders	8276±690 (1200±100)
Bogie Cylinders	11790±690 (1710±100)
Recoil Cylinders	15170±690 (2200±100)

NOTE: The same procedure can be applied to either side of the machine.

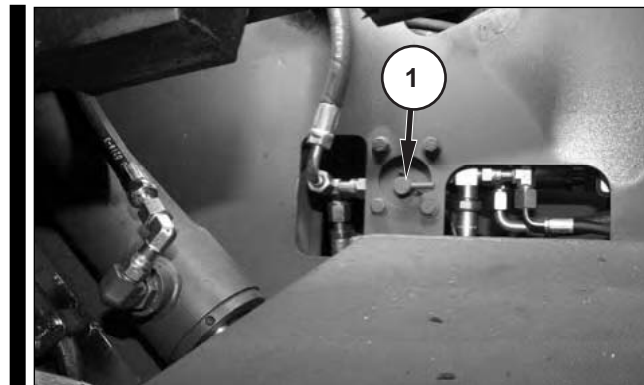

1. Open suspension manual lock valve (1) by rotating the valve clockwise.

NOTE: The emergency drive belt tension procedure will not work if the suspension is locked.

NOTE: Thoroughly clean the couplings of all hoses used in this procedure before connecting the coupling to any port on the machine.

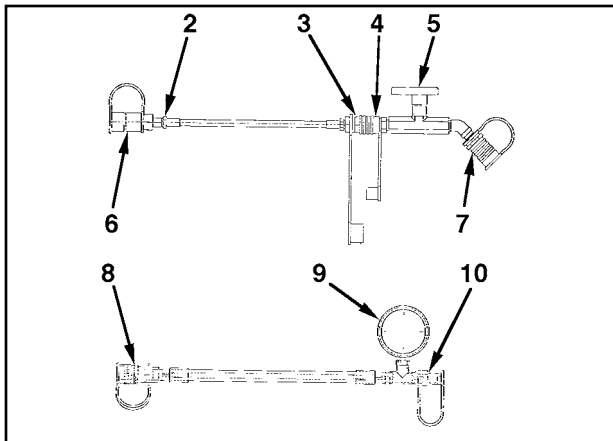

2. Remove the charge hose and the gauge group from the BII compartment. Disconnect coupling (3) from coupling (4) on the charge hose. Connect coupling (8) of the gauge group to coupling (4) of the charge hose. Connect coupling (10) of the gauge group to coupling (3) of the charge hose.

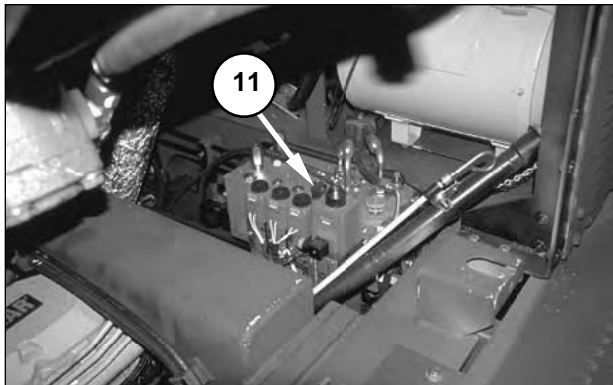

Radiator Shown in Raised Position for Photographic Clarity.

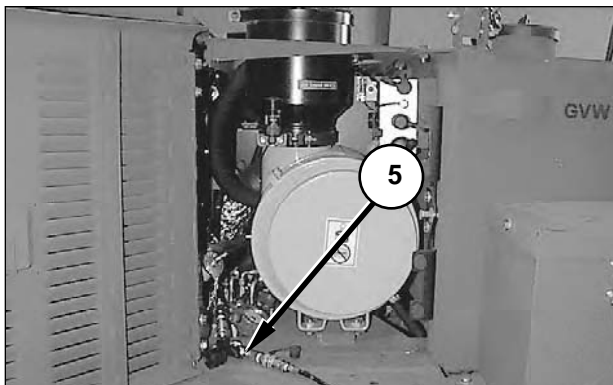

3. Attach coupling (7) to pressure tap (11). Open ball valve (5) on the charge hose (valve knob is in-line with valve body).

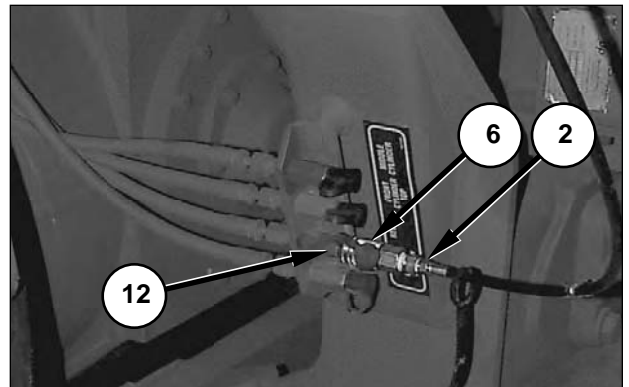

4. Install coupling (6) to "Recoil Cylinder" fitting (12) at the rear of the machine.

NOTE: To install coupling (6) to fitting (12), snap the coupling onto the fitting. Turn nut (2) clockwise until it is hand tight. The hose will turn with the nut.



5. Start the engine. Refer to "Engine Starting" in this section. Leave transmission control lever (13) in NEUTRAL.



6. Move blade control lever (14) towards the rear of the machine to fully raise the blade.

! WARNING

Keep personnel clear of the blade while the blade is raised. The blade could fall, resulting in injury or death.



7. Move the self-deploy/earthmoving switch to SELF-DEPLOY position (15).

NOTE: The machine must be in the SELF-DEPLOY mode to unlock the suspension. Refer to “Machine Operation, Self-Deploy Mode” in this section for the procedure to place the machine in the SELF-DEPLOY mode.

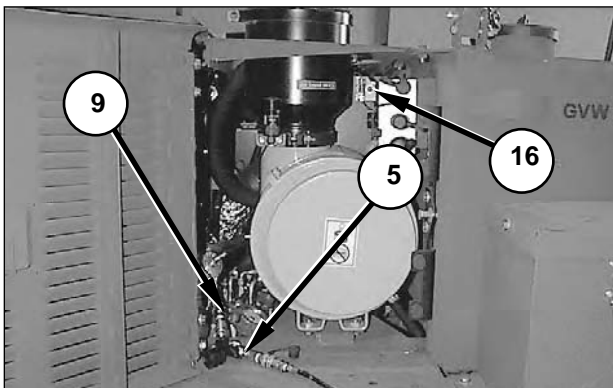

8. With the engine operating at low idle, hold auxiliary charge switch (16) up to direct hydraulic oil into the recoil cylinder.

9. Watch the pressure reading on the pressure gauge on gauge assembly (9).

10. Release auxiliary charge switch (16) and close ball valve (5) (turn the valve knob perpendicular to the valve body) when the pressure reading on the pressure gauge reaches 15 170 kPa (2200 psi).

NOTICE

Overtightening the drive belt will cause accelerated wear of undercarriage components and decreased machine performance.

11. Turn nut (2) three-quarters of a turn counterclockwise (this locks the valve). Open ball valve (5) (turn the valve knob in line with the valve body).
12. Remove coupling (6) from fitting (12).
13. Repeat Steps 4 and 8 through 11 for the other drive belt, if necessary.
14. Remove coupling (7) from pressure tap (11) on the multifunction valve.
15. Turn nut (2) counterclockwise, until the nut stops rotating (an additional three-quarters of a turn may be required). Remove coupling (6) from fitting (12).
16. Disconnect coupling (8) of the gauge group from coupling (3) of the charge hose. Disconnect coupling (10) of the gauge group from coupling (4) of the charge hose. Connect coupling (3) to coupling (4). Return the charge hose and gauge group to the BII compartment for storage.
17. Deliver the machine to Unit Maintenance as soon as possible to recharge the suspension.

Emergency Machine Leveling

WARNING

The hydraulic system operates at high pressure. Wear eye and face protection, gloves and protective clothing when performing this procedure. Failure to comply may result in severe injury or death.

NOTICE

This procedure is for emergency field use to mobilize the machine. If this procedure is performed for any reason, deliver the machine to Unit Maintenance to have the suspension properly charged before returning the machine to normal service.

NOTE: Before performing the emergency machine leveling procedure, fully kneel and raise the machine twice on level ground. Refer to “Machine Features, Kneeling Switch” in this section.

NOTE: The same procedure can be applied to either side of the machine.

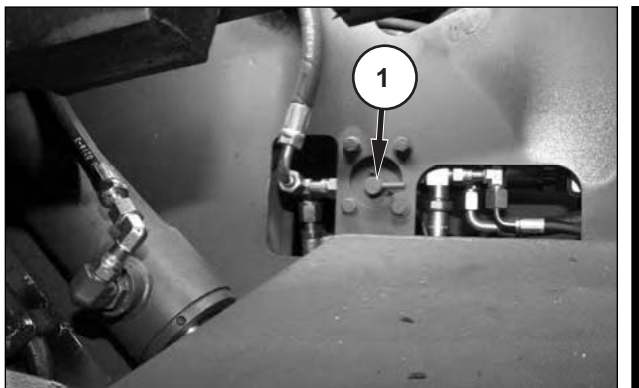

1. Open suspension manual lock valve (1) by rotating the valve clockwise.

NOTE: The emergency machine levelling procedure will not work if the suspension is locked.

NOTE: Thoroughly clean the couplings of all hoses used in this procedure before connecting the coupling to any port on the machine.

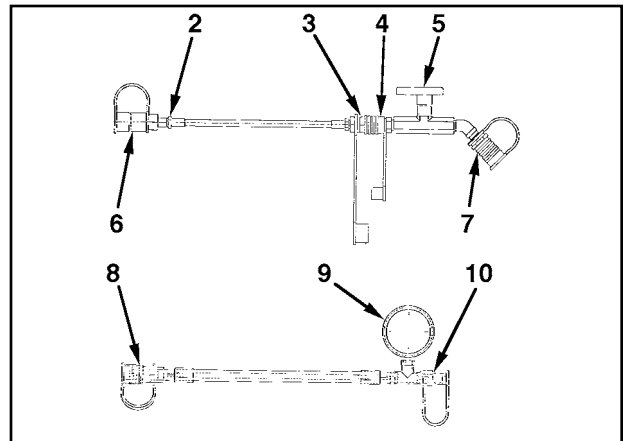

2. Remove the charge hose and the gauge group from the BII compartment. Disconnect coupling (3) from coupling (4) on the charge hose. Connect coupling (8) of the gauge group to coupling (4) of the charge hose. Connect coupling (10) of the gauge group to coupling (3) of the charge hose.

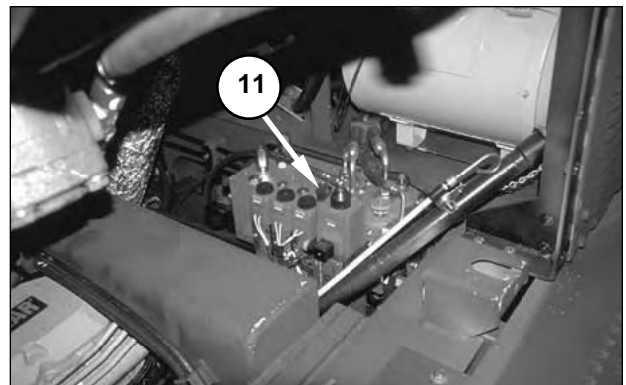

Radiator Shown in Raised Position for Photographic Clarity.

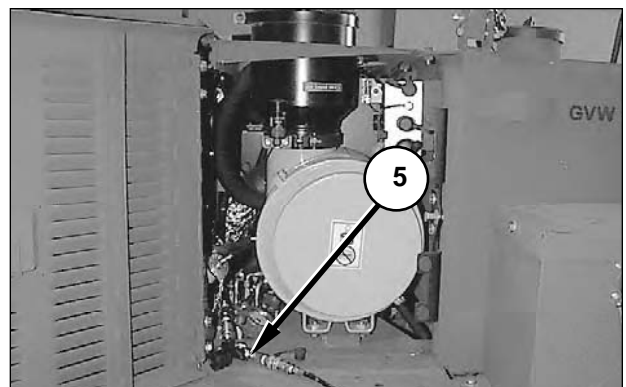

3. Attach coupling (7) to pressure tap (11). Open ball valve (5) on the charge hose (valve knob is in-line with valve body).

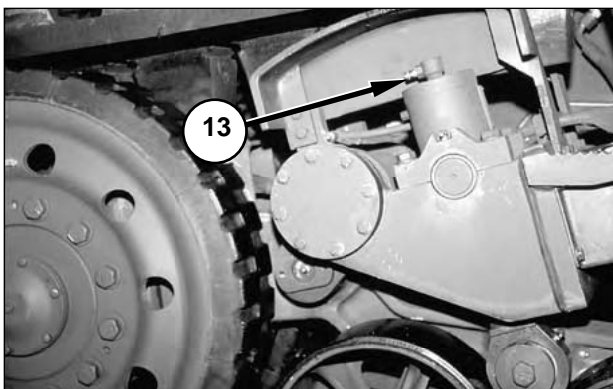
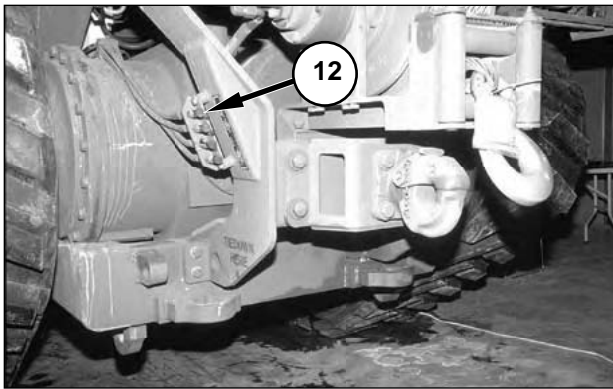

4. If the left rear of the machine is low, install coupling (6) to middle cylinder charge fitting (12). If the left front of the machine is low, install coupling (6) to front bogie cylinder charge fitting (13).

NOTE: To install coupling (6) to fitting (12) or (13), snap the coupling onto the fitting. Turn nut (2) clockwise until it is hand tight. The hose will turn with the nut.



5. Start the engine. Refer to “Engine Starting,” in this section. Leave transmission control lever (14) in NEUTRAL. Operate the engine at low idle.



6. Use blade control lever (15) to raise the blade off the ground.



Keep personnel clear of the blade while the blade is raised. The blade could fall, resulting in injury or death.



7. Move the self-deploy/earthmoving switch (16) into the SELF-DEPLOY position.

NOTE: The machine must be in the SELF-DEPLOY mode to unlock the suspension. Refer to “Machine Operation, Self-Deploy Mode” in this section for the procedure to place the machine in the SELF-DEPLOY mode.

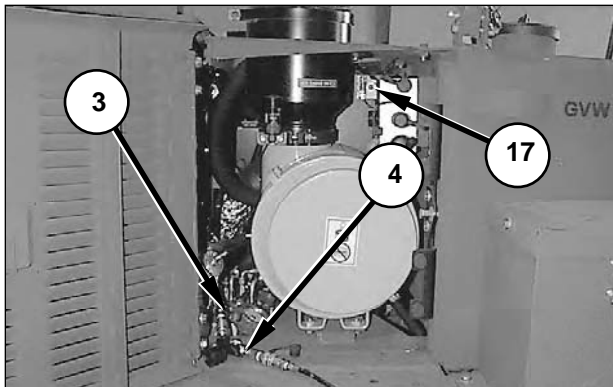

8. To raise the machine, hold auxiliary charge switch (17) up to direct hydraulic oil into the cylinder.
9. Watch the reading on the gauge and the level of the machine.

NOTE: Do not exceed a maximum pressure of 8276 ± 690 kPa (1200 ± 100 psi) when middle cylinder charge fitting (12) is used, and do not exceed a maximum pressure of $11\,790 \pm 690$ kPa (1710 ± 100 psi) when the bogie cylinder charge fitting (13) is used.

10. Release auxiliary charge switch (17) and close the valve (turn the knob perpendicular to the valve body) on ball valve (5) when the machine is level or when the maximum pressure for the cylinder is reached.
11. Turn nut (2) counterclockwise, until the nut stops rotating (an additional three-quarters of a turn may be required).
12. Remove coupling (6) from the fitting of the cylinder which was charged.
13. Repeat Steps 4 and 8 through 12 for the other cylinders until the machine is level.
14. Remove coupling (7) from pressure tap (11).
15. Disconnect coupling (8) of the gauge group from coupling (3) of the charge hose. Disconnect coupling (10) of the gauge group from coupling (4) of the charge hose. Connect coupling (3) to coupling (4). Return the charge hose and gauge group to the BII compartment for storage.
16. Deliver the machine to Unit Maintenance as soon as possible to recharge the suspension.

Moving the Machine

1. Start the engine. Refer to “Before Starting the Engine” and “Engine Starting” in this section for the starting procedure.

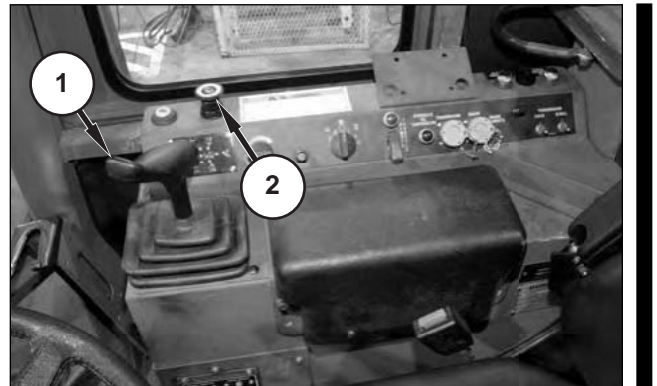

2. Use blade control lever (1) to raise the blade off the ground.

WARNING

Keep personnel clear of the blade while the blade is raised. The blade could fall, resulting in injury or death.

NOTE: If the machine is to be operated in the SELF-DEPLOY mode, the blade must be fully raised.



3. Place self-deploy/earthmoving switch (3) in the desired position.

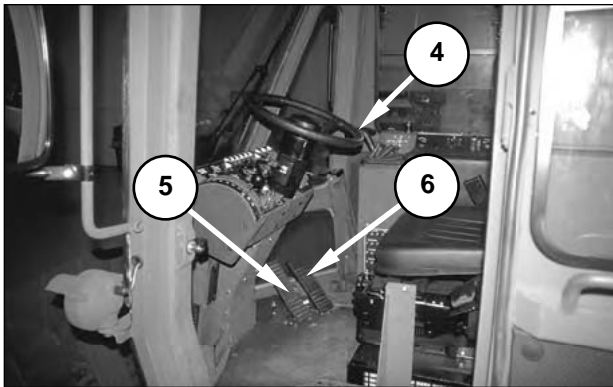

4. Depress service brake pedal (5) to engage the service brake.
5. Push knob (2) in to release the parking brake.

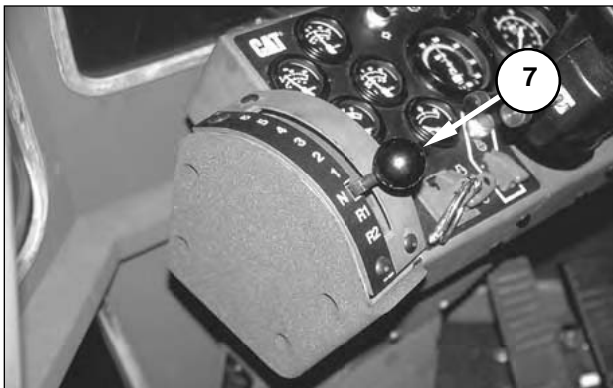

6. Place transmission control lever (7) in the desired gear.

NOTE: In EARTHMOVING mode, the transmission is limited to the REVERSE gears and manual operation of FIRST, SECOND, and THIRD FORWARD. If operating in SELF-DEPLOY mode, the transmission will automatically shift to the highest forward gear selected.

7. Release service brake pedal (5) and accelerate the machine using accelerator pedal (6).
8. Steer the machine using steering wheel (4).
9. Slow and stop the machine by depressing service brake pedal (5).

NOTE: Refer to "Machine Parking" in this section for parking instructions.

Pintle Hook

WARNING

Use caution when operating the pintle hook. It is possible to pinch your fingers in the clasp, causing injury.

NOTICE

Use caution when towing loads at transport speeds (up to 24 kph [15 mph]). Reduce speed if the towed load is not equipped with brakes. Avoid hard braking applications.

NOTICE

Do not operate at speeds greater than 24 kph (15 mph) when towing a load. Exceeding 24 kph (15 mph) while towing a load may damage the machine.

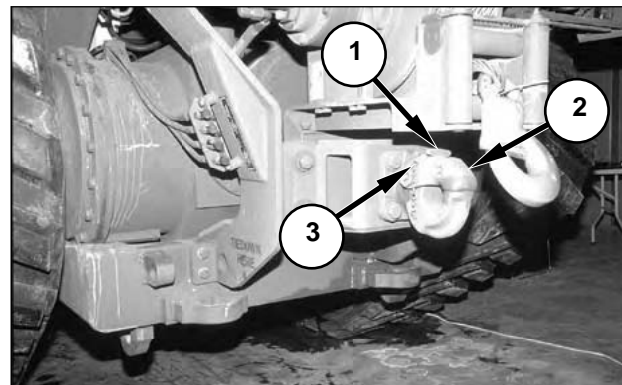

1. Remove pin (3).
2. Pull lever (1) and lift clasp (2) until the clasp locks into the up position.
3. Back the machine up to the load.
4. Lift lever (1) and lower clasp (2).
5. Reinstall pin (3).

Operating Techniques

⚠ WARNING

Alert ground support personnel to stay a minimum of 50 ft from the deuce during dozing operations. Failure to comply may result in injury or death from flying rocks and debris.

NOTE: The illustrations in this section are not specific to the DEUCE. However, the techniques described are valid operating techniques for the DEUCE.

Bulldozing

Straight Dozing

For the best performance during straight dozing, a level cut should be maintained. After the bulldozer blade is filled, the load should be carried to the landfill.

- Do not lug or stall the machine.
- Do not allow the drive belt to spin excessively.
- If the machine must be turned under load, the bulldozer tilt cylinders, not the steering wheel, should be used to steer the machine.

During leveling work, a full bulldozer blade can be managed more effectively than a partially loaded blade.

Slot Dozing

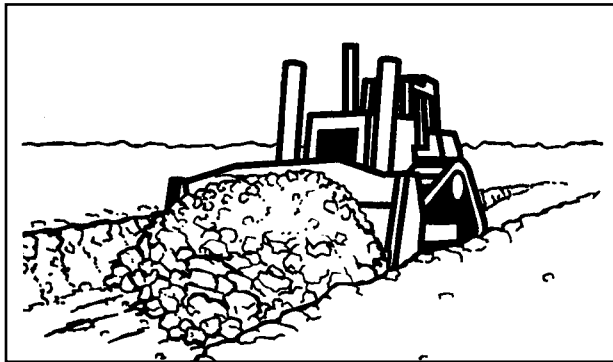

NOTICE
During slot dozing, side wall cave in may occur, potentially causing damage to the drive belt and suspension..

When material is trapped in a slot, larger loads can be carried in front of the bulldozer blade.

Once the depth of the slot exceeds the blade height, production using this method will decrease. Decrease is due to excess spoil falling back over the blade.

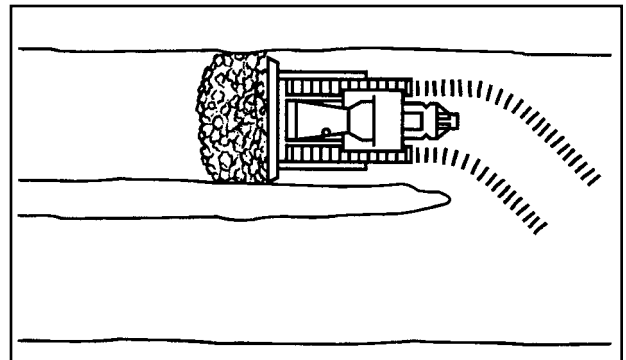

⚠ WARNING

Moderate breaking and reverse gear one (R-1) must be used when backing down any slope. Failure to do so could result in injury or death.

Start at the dump end, and operate rearward. This is shown in Figure (A). This technique permits loading downhill, and the carrying of a load on a level surface. When working from the rear of the slot to the dump end, the previous technique is more efficient. This is shown in Figure (B). Uphill loading does not utilize the slot. This is shown in Figure (B). Level dozing through the entire slot is inefficient, due to the longer distance of the push.

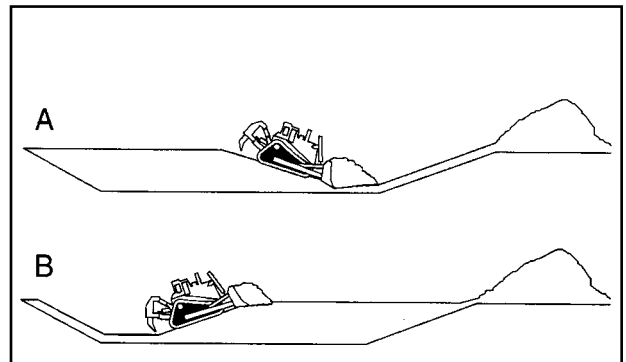

When parallel slots are dug, the center should be removed from the rear. This procedure permits the operator to maintain a slot until the center is removed. The center should be maintained at a minimum width. The maximum width should be approximately one-third of the bulldozer blade.

NOTICE
During earthmoving operations it is possible to collapse the recoil cylinder completely. To reduce the possibility of breaking track belts in this condition, a recoil alarm has been added to the machine to alert the operator to this condition. If the alert sounds, the operator should reverse direction and clear material from the undercarriage.

Machine on a Slope

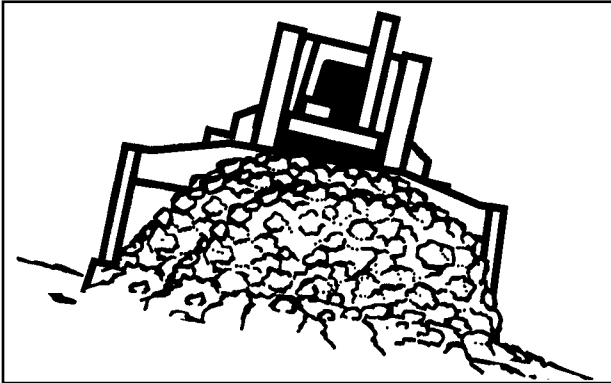

! WARNING

Moderate breaking and reverse gear one (R-1) must be used when backing down any slope. Failure to do so could result in injury or death.

When possible, a slope should be worked vertically.

Banks or slopes must be worked cautiously to avoid machine tipping.

If the machine starts to sideslip on a slope, lighten the load and turn the machine downhill.

When a slope is worked horizontally, start at the top of the slope and work downhill. Maintain a windrow of material on the low side of the machine to provide stability.

Do not undercut the slope. Undercutting will increase the slope.

V-Ditching

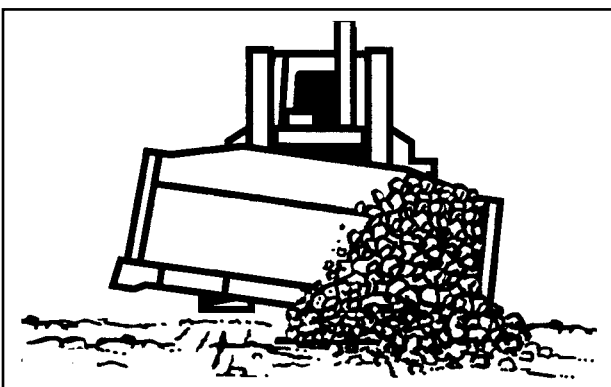

To V-ditch, tilt the bulldozer blade to the desired slope. Position the corner of the bulldozer blade in the center of the ditch, and cut the ditch to the desired depth.

Backfilling

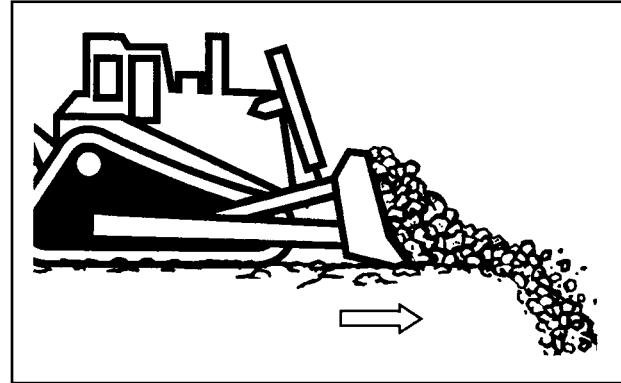

Backfill material should be pushed into a trench at a 90° angle to the trench. Do not twist the machine on a new backfill. When material is cut on a side slope, material may fall on the machine.

Roading Information

NOTE: Required permits must be obtained before the machine is operated on a public road. Check with local officials to determine if permits are required.

Before the machine is driven, Army operators should perform the “Operator’s Preventative Maintenance Checks and Services (OPMCS)” as described in “Appendix A.”

If a drive belt is loose, perform the procedure described in “Operation Section, Machine Operation, Emergency Suspension Charging, and Emergency Drive Belt Tension Procedure” in this manual.

Use the SELF-DEPLOY mode when driving the machine on a public road. Refer to “Operation Section, Machine Operation, Self-Deploy Mode” in this manual.

Place the blackout switch in the position which meets the requirements of the current situation. Refer to “Operation Section, Monitoring Systems and Cab Features, Blackout Light Switch” in this manual.

! WARNING

The work lights may impair the vision of drivers of approaching vehicles, which may cause injury or fatal accidents. Therefore, when traveling on public roads or accesses, ensure that the work light switch is in the OFF position. Refer to “Operation Section, Monitoring Systems and Cab Features, Work Light Switch” in this manual.

Travel at moderate speeds. Do not exceed the speed limit on public roads.

NOTE: The maximum travel speed of the machine is 48 kph (30 mph). Maximum attainable speed is dependent on ambient temperature, oil level, and oil weight. The fluids must be at normal operating temperature, and the machine must be operated on level terrain to reach 48 kph (30 mph).

! WARNING

Reduce travel speed if directional stability is noticeably diminished. Always use the seat belt when operating the machine. Loss of machine control can result in injury or death.

Back Ripping**General Ripping Technique**

When the back rippers are used, the machine should be operated in the EARTHMOVING mode with the transmission in FIRST SPEED REVERSE. If additional production is required, use additional shanks instead of increasing the ripping speed.

NOTICE

When ripping is performed, the machine must be driven in a straight line. Also, all four rippers must be used at the same time or the rippers must be used in symmetrical pairs.

NOTICE

Do not turn the machine while the ripper shanks are in the ground. The shanks may fail if they are twisted.

Use the accelerator pedal to match the drawbar pull to the underfoot conditions. Do not allow the drive belt to slip.

Rip the ground as deep as the underfoot conditions will allow. Partial depth ripping may be required. Remove the material in natural layers.

The depth and width of the pass control the sizing of the ripped material.

The back rippers are not intended for use in rock or in deep ripping applications. Only use the ripper shanks which are specified in *Parts Manual, Deployable Universal Combat Earthmover (DEUCE)*.

Ripping Technique for Packed Soil, Hardpan, or Clay

Follow the recommendations given in “General Ripping Technique,” above.

Use the greatest possible number of shanks to break the material to the desired size. The number of shanks used should not cause the machine to stall or hang up.

NOTE: Four shanks usually work well in these materials.

Operation in High Ambient Temperatures (Above 38°C [100°F])

In high ambient temperatures, the gauges must be checked more often. If a system is overheating, reduce the load, and allow the system to cool to normal operating temperature.

NOTICE

To prevent the fuel from overheating, the fuel level should be maintained above one-half of a tank. Overheated fuel can cause reduced power and possibly damage the fuel system.

The operator's preventative maintenance checks and services should be performed more often than normal. Refer to “Appendix A, Operator’s Preventive Maintenance Checks and Services (OPMCS)—DEUCE.” Contact Unit Maintenance for assistance in determining new maintenance intervals.

Machine Parking

Machine Stopping

NOTE: If possible, park the machine on level ground. If the machine must be parked on a grade, block both drive belts on the downhill side of the machine.

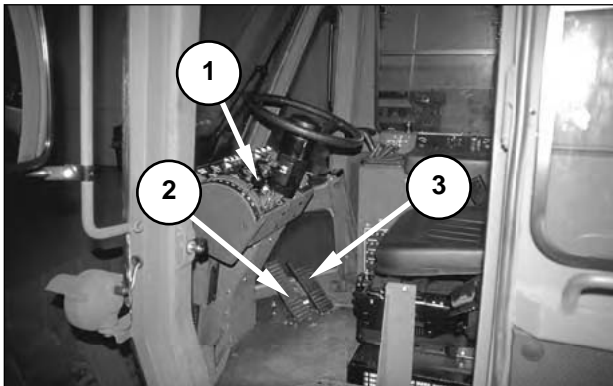

1. In preparation to park the machine, release accelerator pedal (3) to decrease engine speed.
2. Depress service brake pedal (2), and move transmission control lever (1) to a lower gear, to slow the machine travel speed.
3. Fully depress service brake pedal (2) to stop the machine.

WARNING

With the engine running, this machine will spot turn when the steering wheel is turned, even if the transmission is in NEUTRAL.

To avoid personal injury due to unexpected movement, engage the parking brake and make sure the area is free of personnel before starting the engine.

4. Move transmission control lever (1) into NEUTRAL.

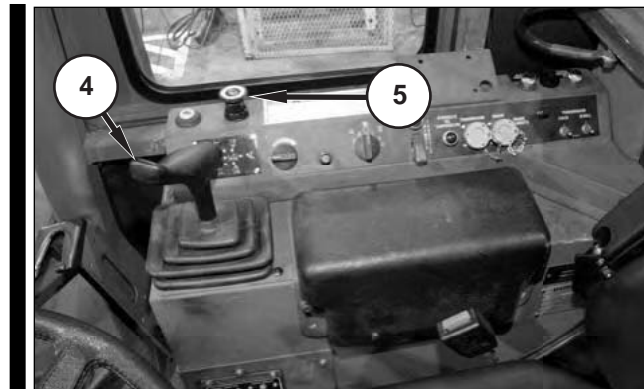

5. Pull knob (5) up to engage the parking brake.

NOTE: Service brake pedal (2) can be released after the parking brake is engaged.



6. Move the self-deploy/earthmoving switch (6) into EARTHMOVING position.
7. Move blade control lever (4) forward to LOWER the blade to the ground. Apply a slight downward pressure with the blade after the blade contacts the ground.

NOTE: When the engine is operating, the machine must be in the EARTHMOVING mode before the blade will lower. When the engine is not operating, movement of the blade control lever will allow the blade to lower.

NOTE: If the engine is to be stopped, refer to “Machine Parking, Engine Stopping” in this section for engine shutdown instructions.

Engine Stopping

NOTICE

Stopping the engine immediately after it has been working under load can result in overheating and accelerated wear of the engine components.

Follow the engine stopping procedure, outlined below, to allow the engine to cool and to prevent excessive temperatures in the turbocharger center housing which causes oil blocking problems.

1. Stop the machine. Refer to “Machine Parking, Machine Stopping” in this section for the procedure to stop the machine.
2. Operate the machine at low idle for five minutes. This allows hot areas in the engine to cool gradually, extending engine life.



3. Close cover (1) to move the engine start switch to the OFF position and to stop the engine.

Leaving the Machine



1. Stop the engine following the procedure given in “Machine Parking, Engine Stopping” in this section, and install start switch cover locking pin (1).

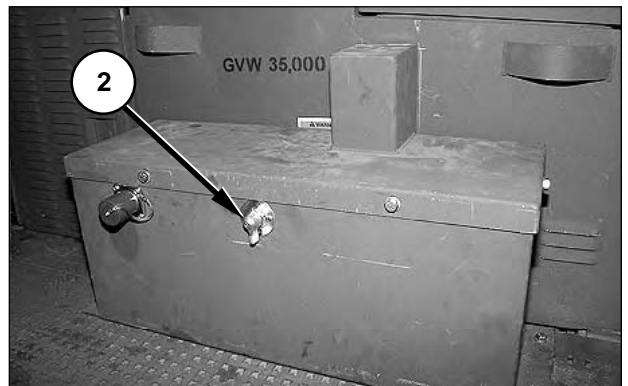

2. Move disconnect switch (2) to the OFF position, if the machine is equipped with the optional arctic batteries. Refer to “Machine Features, Main Disconnect Switch” in this section.

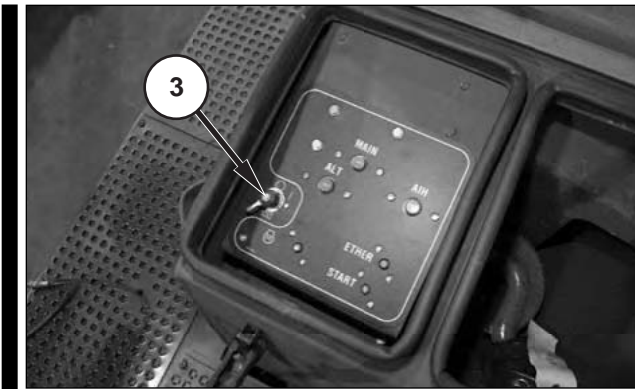

3. Open the electrical panel and BII compartment at the rear of the machine, and turn main disconnect switch (3) to the OFF position. Refer to “Machine Features, Main Disconnect Switch” in this section.

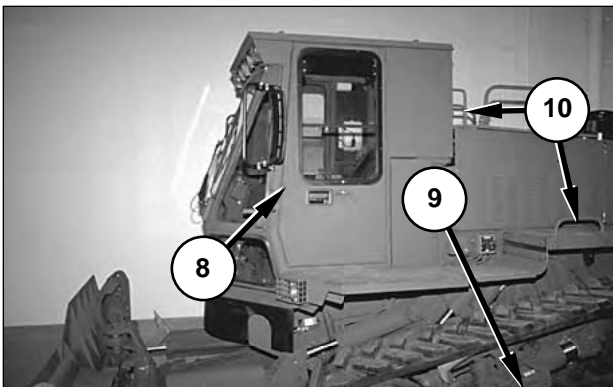

4. If necessary, install padlocks on start switch locking pin (1), fuel tank cap (4), electrical panel and BII compartment (5), tool/battery box (6), hydraulic tank cap (7), and cab door (8).

5. Dismount the machine, maintaining three-point contact with hand holds (10) and step (9).

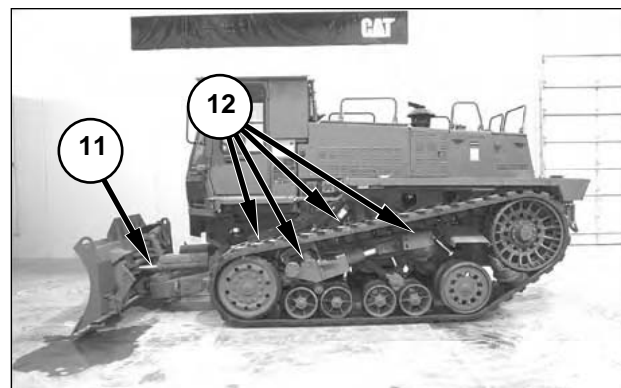
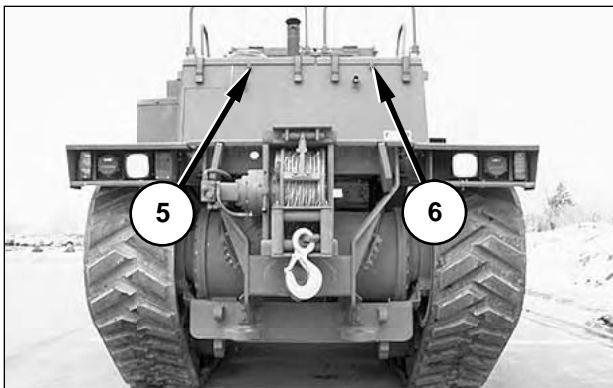

6. Inspect back side (11) of the blade and inside (12) of the drive belt components on both sides of the machine for any accumulation of debris. Clean out any debris before the debris hardens.

Transportation Information

General Information

Machine Shipping

For machine shipping specifications, refer to “General Section, Specifications and Model Views” in this manual.

NOTICE

Remove any ice, snow or other slippery material from the shipping machine and loading dock before loading the machine.

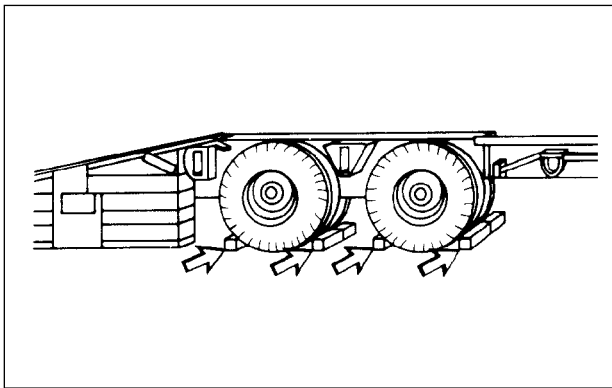

Always block the trailer or rail car wheels before loading the machine.

Load the machine with the rear end forward to avoid damage if the cab door opens during transport.

Block the front and rear of the drive belts, and tie the machine down before moving the hauling vehicle.

Cover the engine exhaust opening to prevent the turbocharger from spinning in transit. If the machine is loaded with the rear end towards the front of the transport vehicle, the rain cap on the exhaust stack must be fastened down.

Comply with regulations governing weight, width and length of load.

NOTICE

Protect the cooling system with an antifreeze mixture rated to the lowest expected temperature on the travel route, or, drain the cooling system completely after the machine is loaded for transport. If the cooling system is drained, refill the system before starting the engine to unload the machine. Operating the machine without coolant will damage the engine.

Ground Transportation

1. Drive the machine to the loading area. For operating instructions, refer to “Before Starting the Engine,” “Engine Starting,” “After Starting Engine,” and “Machine Parking” in this section.

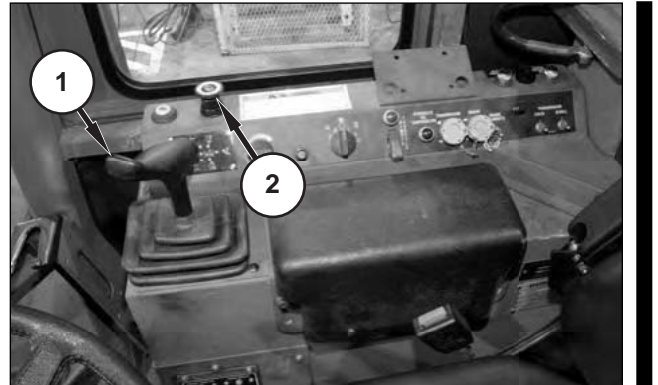

2. Move blade control lever (1) towards the rear of the machine to fully raise the blade.



3. Place the self-deploy/earthmoving switch (3) into SELF-DEPLOY position.
4. Drive the machine onto the hauling unit so that the rear end of the machine faces forward.

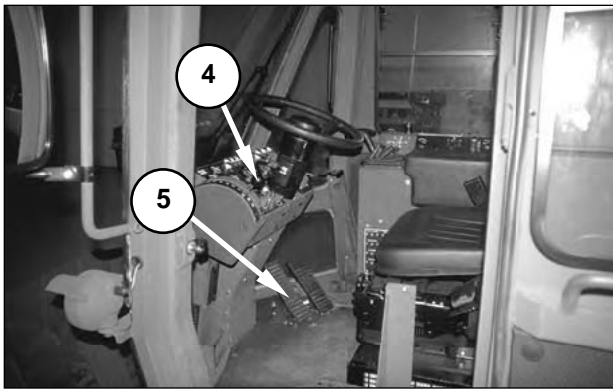

5. With service brake pedal (5) depressed, move transmission control lever (4) to NEUTRAL.
6. Pull knob (2) up to engage the parking brake before releasing service brake pedal (5).
7. Place the self-deploy/earthmoving switch (3) into EARTHMOVING position.

NOTE: If necessary, the blade can be collapsed to reduce the total shipping width. For the procedure to collapse the blade, refer to “Special Shipping Preparation” in this section.

8. Move blade control lever (1) towards the front of the machine, and lower the blade until the blade contacts the bed of the hauling unit.
9. Stop the engine. Refer to “Machine Parking, Engine Stopping,” and “Machine Parking, Leaving the Machine” in this section for procedures for stopping the engine and leaving the machine.
10. Block the front and rear of each drive belt.
11. Secure the machine to the hauling unit using the tie down locations on each side of the machine. Refer to “Transportation Information, Tie Downs” in this section for the tie-down locations.

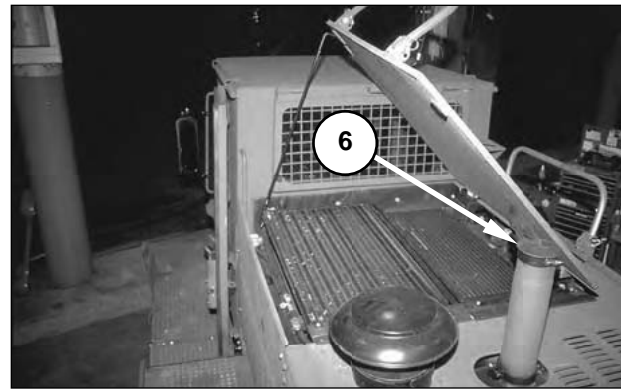

12. Secure engine exhaust cover (6) down to prevent wind and water entry into the engine.
13. Secure all windows, doors, and compartments before shipping the machine.

Machine Roading

Check the travel route for overpass clearances. Make sure there is adequate clearance.

The military load classification for this vehicle is 20. This number is stenciled on the right side of the cab.

Check and obey all local and traffic regulations.

Machine Lifting and Tie Downs

Lifting

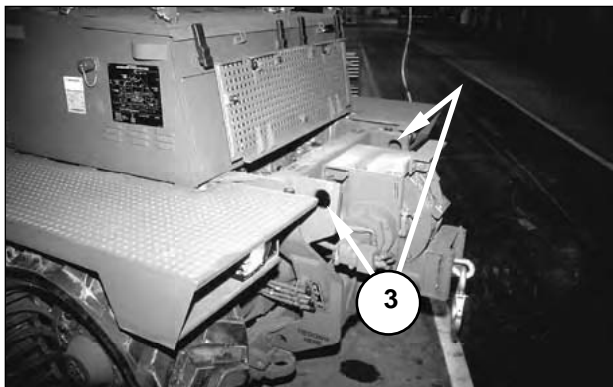
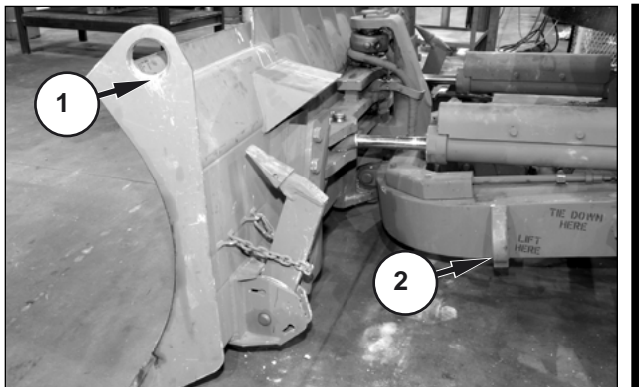

! WARNING

Improper lifting can allow the load to shift and cause injury or damage.

One lifting eye (1) is located on either side of the blade. Use these lifting eyes to lift the blade. The blade should be fully raised when the machine is lifted.

One lifting eye (2) is located on either side of the C-frame. One lifting eye (3) is located on either side of the winch. Use lifting eyes (1) and (3) to lift the machine. The blade should be fully raised when the machine is lifted.

NOTICE

Do not use lifting eyes (2) for single-point lifting when the ROPS (top half of cab shell) is installed. The rigging will interfere with the top of the cab. Use lifting eyes (1) for single-point lifting with the ROPS installed.

Refer to lifting information plate (4) for lifting and slinging information and the center of gravity location.

The gross vehicle weight of the machine is 16 140 kg (35, 500 lb). The weight given here apply to machines as manufactured by Caterpillar Inc.

Use properly rated cables and slings for lifting. Position the crane for level lifting.

Tie Downs

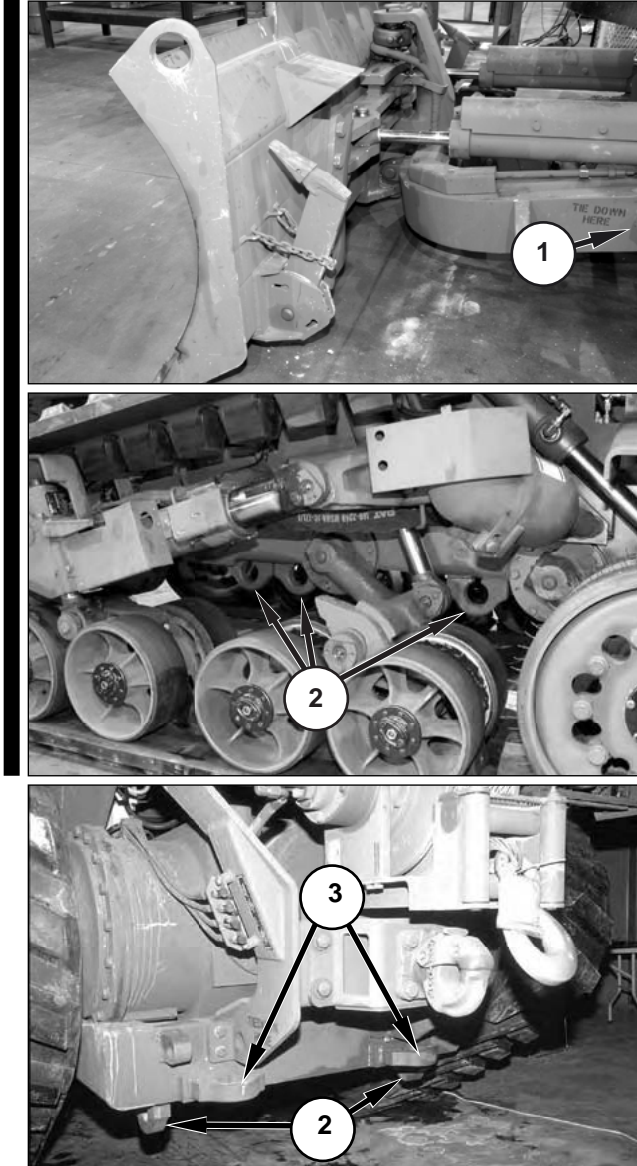

The machine is equipped with 12 tie-down locations: one (1) on each side of C-frame, four (2) on each side of machine frame, and two (3) under the winch.

WARNING

Use an appropriate tie-down method for a machine with a gross vehicle weight of approximately 16 140 kg (35,500 lb). Failure to properly secure the machine during transport can result in injury or death.

Preparation for Air Transport (C-130, C-141, C-5)

This machine is capable of drive-on and drive-off loading on the C-130, C-141 and C-5 aircraft. To prepare the machine for drive-on/drive-off, follow the procedure below. The Aircraft Loadmaster may require shoring to distribute floor loading. Before the machine is driven on an aircraft, remove antennas and other items from the machine which may interfere with the loading process.

NOTICE

Protect the cooling system with an antifreeze mixture rated to the lowest expected temperature on the travel route, or, drain the cooling system completely after the machine is loaded for transport. If the cooling system is drained, refill the system before starting the engine to unload the machine. Operating the machine without coolant will damage the engine.

Drive On

1. Drive the machine to the loading area.

NOTE: For operating instructions, refer to “Before Starting the Engine,” “Engine Starting,” “After Starting Engine,” and “Machine Parking” in this section.

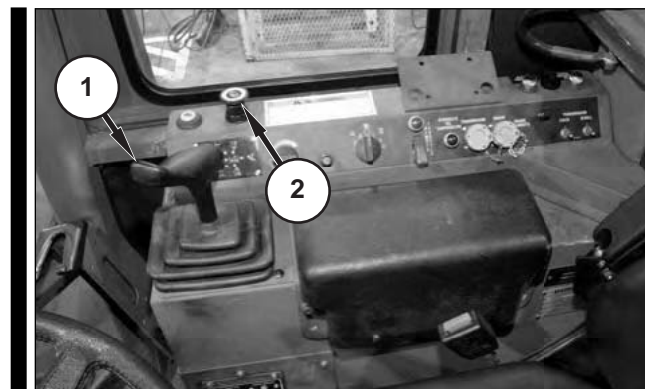

2. Install castor wheels on blade. Refer to “Castor Wheel Installation”, in this manual.

- a. Move blade control lever (1) towards the rear of the machine to fully raise the blade.

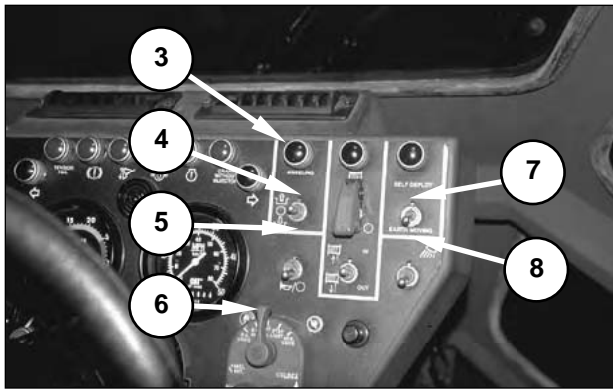

3. Place blackout light switch (6) in the STOP LIGHT or SERVICE DRIVE position. Refer to “Monitoring Systems and Cab Features, Switches” in this section for details about positions of blackout light switch (6).
4. Place the self-deploy/earthmoving switch into SELF-DEPLOY position (7).
5. Move the kneeling switch down to LOWER (4), and hold the switch in the LOWER position until kneeling indicator (3) illuminates.

! WARNING

With the kneeling switch in the LOWER position, the front of the machine lowers, reducing clearance between the walkways and the drive belts and also causing the blade position to lower. Keep personnel clear of the machine when lowering the machine.



6. Use the pump handle to install the kneeling lock pin on both sides of the machine when locking bar (10) aligns with the hole in bracket (9).

NOTE: The kneeling lock pins and pump handle are stored in the electrical panel and Bll compartment at the left rear of the machine.

NOTICE

The kneeling lock pins must be installed to secure the machine in the kneeled position.

Do not operate the machine at speeds greater than 3 kph (2 mph) in the kneeled position.

7. Lower all grab rails. Refer to “Machine Features, Grab Rails” in this section.
8. Place the self-deploy/earthmoving switch into EARTHMOVING position (8).
9. Place the blade in the float position.

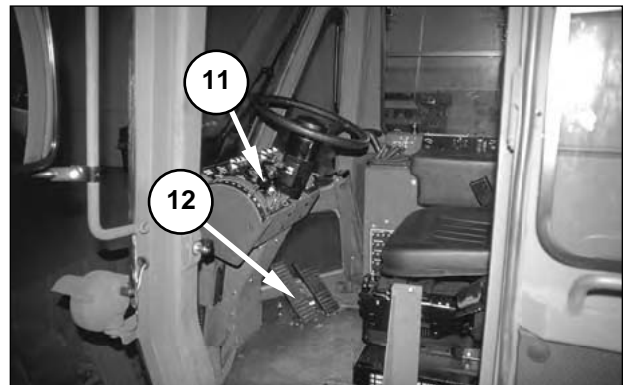

10. Move transmission control lever (11) to first gear, and slowly drive the machine onto the aircraft.
11. When the machine is in place on the aircraft, depress service brake pedal (12), and move transmission control lever (11) into NEUTRAL.

! WARNING

With the engine running, this machine will spot turn when the steering wheel is turned, even if the transmission is in NEUTRAL.

To avoid personal injury due to unexpected movement, engage the parking brake and make sure the area is free of personnel before starting the engine.

12. Pull knob (2) up to engage the parking brake before releasing service brake pedal (12).

NOTE: If necessary, the blade can be collapsed to reduce the total shipping width. Refer to “Transportation Information, Preparation for Special Shipping Width” in this manual.

13. Move blade control lever (1) to HOLD.
14. Stop the engine. Refer to “Machine Parking, Engine Stopping,” and “Machine Parking, Leaving the Machine” in this section for procedures for stopping the engine and leaving the machine.
15. Block the front and rear of each drive belt.
16. Secure the machine to the floor of the aircraft by using the six tie-down locations on each side of the machine. Refer to “Transportation Information, Tie Down” in this section for the tie-down locations.

Drive Off

NOTICE

If the cooling system was drained for transport, refill the system before starting the engine. Operating the machine without coolant will damage the engine.

1. Start the engine.

NOTE: For operating instructions, refer to “Before Starting the Engine,” “Engine Starting,” “After Starting Engine,” and “Machine Parking” in this section.

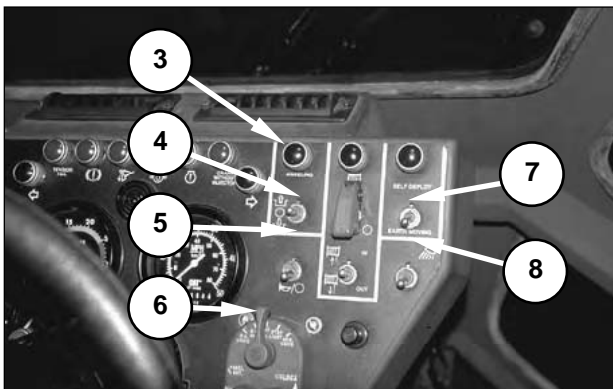

2. Ensure that blackout light switch (6) is in the STOP LIGHT or SERVICE DRIVE position.

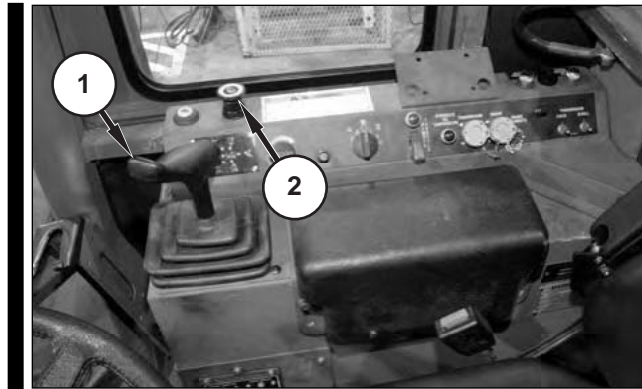

3. Move blade control lever (1) toward the front of the machine to fully lower the blade into the float position.
4. Drive the machine off the aircraft.

NOTICE

Do not operate the machine at speeds greater than 3 kph (2 mph) in the kneeled position.

5. When the machine is in an open location, depress service brake pedal (12), and move transmission control lever (11) to NEUTRAL.
6. Pull knob (2) up to engage the parking brake before releasing service brake pedal (12).
7. Move the self-deploy/earthmoving switch into SELF-DEPLOY position (7).
8. Move the kneeling switch to LOWER (4). Hold the kneeling switch in the LOWER position for several seconds to release any force on the kneeling lock pins caused by natural leakage inside the kneeling cylinders.
9. Remove the kneeling lock pins on both sides of the machine and return the pins to the electrical panel and BII compartment for storage.
10. Move the kneeling switch to RAISE (5). Hold the kneeling switch in the RAISE position until the machine is fully raised.
11. Remove castor wheel assembly. Refer to “Castor Wheel Installation and Removal”, in this manual

Preparation for Special Shipping Width

The shipping width of the machine can be reduced to 2591 mm (102 in). Notify Unit Maintenance personnel to prepare the machine for the special shipping width. Refer to Appendix E for Unit Level transportation procedure. U.S. Army Operators are not authorized to perform the procedures in Appendix E.

Towing Information

WARNING

Personal injury or death could result when towing a disabled machine incorrectly.

Be sure all necessary repairs and adjustments have been made before a machine that has been towed to a service area is put back into operation.

Follow the recommendations below to properly perform the towing procedure.

NOTICE

The winch cable is rated at 195 712 N (44,000 lb). This cable can be used for self-recovery but cannot be used to tow another DEUCE.

NOTICE

This machine is equipped with internally, spring-applied parking brakes. The parking brakes must be hydraulically released before the machine can be towed. Also, the final drives must be disabled before the machine is towed. Failure to release the parking brake and/or disable the final drives before the machine is towed can damage the machine. Notify Unit Maintenance to perform these procedures if the machine must be towed.

NOTE: This information is not authorization for the operator to maintain additional tools or to perform maintenance tasks.

These towing instructions are for moving a disabled machine a short distance, at low speed (no faster than 2 kph [1.2 mph]) to a convenient location for repair. These instructions are for emergencies only. Always haul a disabled machine if long distance moving is required.

Shielding must be provided on the towing machine to protect the operator if the tow line, or bar, should break. The rear window screen on the DEUCE must be down when the machine is towing or being towed.

Do not allow an operator on the machine being towed since it is not possible to control the steering and braking.

Before towing, make sure the tow line, or bar, is in good condition and has enough strength for the towing situation involved. Use a towing line, or bar,

with a strength of at least 1.5 times the gross weight of the towing machine for a disabled machine stuck in the mud, or when towing on a grade.

Do not use a chain for pulling. A chain link may break, causing possible injury. Use a wire rope cable with loop or ring ends. An observer (in a safe position) should stop the pulling procedure if the cable starts to break or unravel. Stop pulling whenever the pulling machine moves but the towed machine does not.

Keep the tow angle to a minimum. Do not exceed a 30-degree angle from the straight-ahead position.

Quick machine movement could overload the tow line, or bar, and cause it to break. Gradual and smooth machine movement works better.

Normally, the towing machine should be as large as the disabled machine. Satisfy yourself that the towing machine has enough brake capacity, weight and power, to control both machines for the grade and distance involved.

To provide sufficient control and braking when towing a disabled machine down a hill, a larger towing machine or additional machines connected to the front may be required. This prevents it from rolling uncontrollably.

All different situational requirements cannot be given, as minimal towing machine capacity is required on smooth level surfaces, and increased capacity is required on inclines or poor surface conditions.

Any towed machine, when loaded onto a trailer, must be equipped with its own brake system which is operable from the operator's compartment.

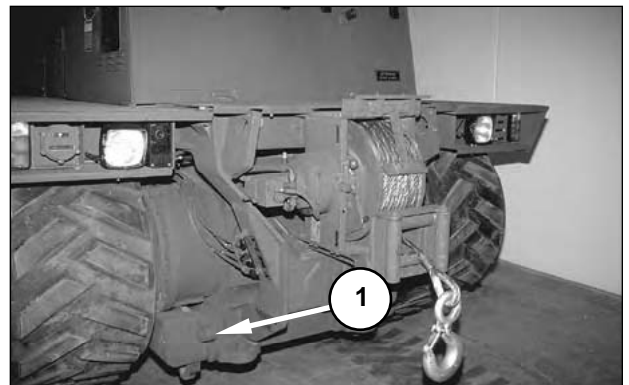

When towing the machine, use towing brackets (1) at the rear of the machine, on both sides of the winch.

Troubleshooting

Engine Diagnostic Codes

Entering Engine Diagnostic Mode

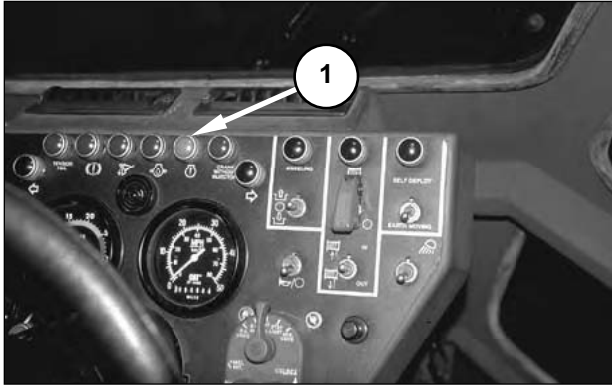

NOTE: Enter the engine diagnostic mode if check engine indicator (1) is illuminated. Use the engine diagnostic to retrieve any stored engine diagnostic codes.

NOTE: The blackout light switch must be in STOP LIGHT or SERVICE DRIVE for the check engine indicator to function.

NOTE: The engine may be running or not running during this procedure.

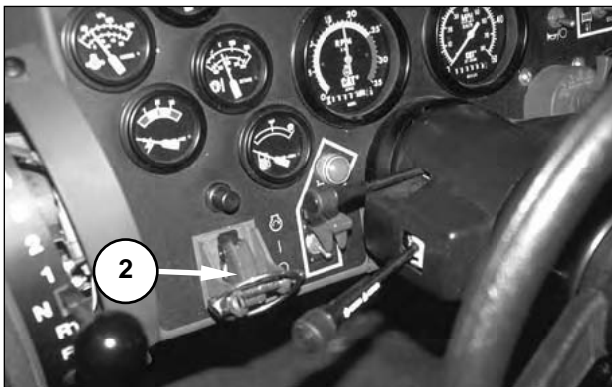

1. Lift cover (2) on the engine start switch, and move the engine start switch into the ON position.

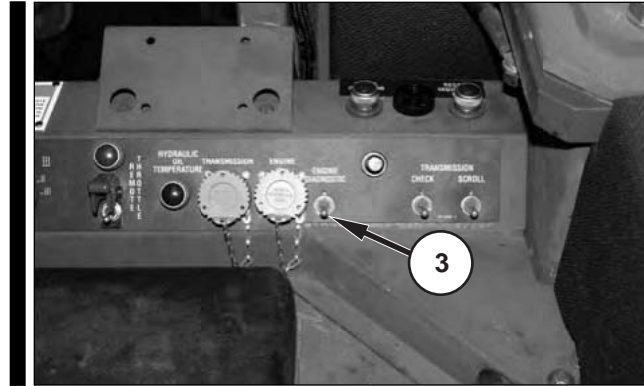

2. Hold engine diagnostic switch (3) up to initiate the engine diagnostic mode.

Interpreting Error Codes

If there are any active errors in the ECM, check engine indicator (1) on the instrument panel will flash a set of two numbers for each error.

For example, to indicate an error code of "42," the light will blink four times, followed by a short pause, and then the light will blink two times. There is a longer pause between each set of error codes.

When the ECM has flashed the code for every active error, it will repeat from the beginning with the first error code.

NOTE: An error code of "55" indicates that there are no active errors detected.

Refer to the chart on the next page for a list of error codes, the effect the error will have on engine performance, and the suggested action to take if the error code is present.

DIAGNOSTIC FLASH CODE/ENGINE PERFORMANCE RELATIONSHIP-3100 HEUI VEHICLE ENGINE (DEUCE)							
Diagnostic Flash Codes	EFFECT ON ENGINE PERFORMANCE				SUGGESTED ACTION		
	Engine Misfire	Low Power	Engine Speed Reduced	Engine Shutdown	Shutdown Machine	Service ASAP	Schedule Service
12—Crank-Without-Inject Fault							
15—Injection actuation pressure sensor fault	✓	✓				✓	
17—Injection actuation pressure fault	✓	✓				✓	
18—Injection actuation pressure driver fault	✓			✓		✓	
21—Sensor supply voltage fault ¹	✓	✓				✓	✓
25—Boost pressure sensor fault ¹		✓					✓
26—Rating select input fault		✓	✓				
27—Coolant temperature sensor fault ¹						✓	✓
28—Throttle sensor calibration fault			✓			✓	
32—Throttle position sensor fault			✓			✓	
34—Engine rpm signal fault							✓
37—Engine oil temp sensor fault						✓	
38—Inlet manifold temp sensor fault ¹	✓						✓
39—Injection actuation pressure system fault	✓	✓		✓		✓	
42—Timing sensor calibration fault							
49—Inlet air heater fault ¹							✓
51—Low/intermittent power to ECM	✓			✓		✓	
55—No detected faults							
56—Check customer/system parameters		✓	✓				✓
59—Incorrect engine software				✓		✓	
72—Cylinder 1 or 2 fault	✓	✓				✓	
73—Cylinder 3 or 4 fault	✓	✓				✓	
74—Cylinder 5 or 6 fault	✓	✓				✓	
88—Ether start relay fault	✓						✓
89—Start-aid indicator fault							✓
91—Crank-without-inject indicator fault							✓

¹—These diagnostic flash codes may affect the system only under specific environmental conditions, such as engine start-up at cold temperature, cold weather operation at high altitude, etc.

Shutdown Machine: Drive the machine to a safe stopping area and get immediate service. Severe engine damage may result.

Service ASAP (As Soon As Possible): The operator should go to the nearest qualified service location.

Schedule Service: The operator should have the problem investigated when convenient.

Operational Troubleshooting

This section describes possible problems and provides basic solutions to problems which may be encountered during machine operation. This section is only a guide: not all possible problems and corrections are addressed. If a problem is not covered, or if the problem is not corrected by the action described in this section, refer the problem to Unit Maintenance for resolution.

Problem List

1. Starter Fails to Crank When Start Switch Is Held in START Position.....	88
2. Engine Cranks but Will Not Start	89
3. Engine Runs Roughly After Starting	90
4. Engine Smokes More Than Normal After Warm-up.....	91
5. Engine Overheats During Normal Operation.....	91
6. Greater-Than-Normal Fuel Consumption	92
7. Greater-Than-Normal Oil Consumption.....	93
8. Low Engine Oil Pressure.....	93
9. Engine Stops During Operation	93
10. Engine Power Less Than Normal.....	94
11. Transmission Will Not Go in Any Gear	94
12. Transmission Will Not Shift into High Gear in SELF-DEPLOY Mode	95
13. Transmission Overheats During Normal Operation	95
14. Parking Brake Will Not Release	95
15. Service Brakes Slip.....	96
16. Machine Drifts or Pulls to One Side During Straight Travel	96
17. Machine Turns in Opposite Direction Than Expected During REVERSE Travel	96
18. Machine Not Level on Level Ground.....	96
19. Hydraulic Functions Erratic or Noisy	97
20. Blade Functions Exhibit Less Power Than Normal	97
21. Blade Will Not Lower	97

22. Lights Do Not Work.....	98
23. Cab Blower Produces Less Air Flow Than Normal	98
24. Recoil Alert Sounds During Earthmoving Operations.....	98

Problem 1: Starter Fails to Crank When Start Switch Is Held in START Position

Probable Cause(s):

- Transmission not in NEUTRAL
 - Main disconnect switch OFF
 - Circuit breaker(s) tripped
 - Batteries not providing voltage
1. Transmission not in NEUTRAL:
 - a. Inspect the position of the transmission control lever. If the transmission control lever is in NEUTRAL, go to Step 2. If the transmission control lever is not in NEUTRAL, go to Step b.
 - b. Move the transmission control lever to NEUTRAL, and attempt to start the engine again. If the engine does not crank, go to Step 2.
 2. Main disconnect switch OFF:
 - a. While holding the start switch in the START position, observe the tension fail indicator, the low brake pressure indicator, the engine oil pressure indicator, and the hydraulic oil temperature indicator. If any of these lamps illuminates, go to Step 3. If none of these lamps illuminates, go to Step b.
 - b. Check the position of the main disconnect switch. If the main disconnect switch is ON, go to Step 3. If the main disconnect switch is OFF, go to Step c.
 - c. Move the main disconnect switch to ON, and attempt to start the engine again. If the engine will not crank, go to Step 3.
 3. Circuit breaker(s) tripped:

Reset the following circuit breakers: main, start switch, ECM, and EPTC II. Attempt to start the engine again. If the engine will not crank, go to Step 4.

4. Batteries not providing voltage:

**WARNING**

Batteries produce flammable gasses. Do not smoke when working around batteries. Open flames or sparks can cause an explosion.

Remove jewelry and dog tags when working with batteries. Metal shorting across battery poles can cause electrical shock.

Batteries contain a strong acid solution. Wear protective gloves and safety glasses or goggles when working around batteries.

- a. With the start switch in the ON position, observe the position of the needle in the voltmeter. If the needle lies within the first green zone, go to Step b. If the needle in the voltmeter points to the first red zone, go to Step c.
- b. The batteries are fully charged. Refer the problem to Unit Maintenance for repair.
- c. Inspect the battery for damage, or loose or corroded connections. Clean and apply grease to the battery terminals and terminal clamps. Tighten terminal clamps to the battery terminal clamps. Proceed to Step d.
- d. Attempt to start the engine again. If the engine does not crank, refer the problem to Unit Maintenance for repair.

Problem 2: Engine Cranks but Will Not Start**Probable Cause(s):**

- No fuel or incorrect fuel
- Engine in crank-without-inject mode
- Needle valve open
- Engine oil level low
- Restriction in air intake system
- Cold ambient temperatures
- Batteries not providing sufficient voltage

1. No fuel or incorrect fuel:

**WARNING**

Diesel fuel is combustible. Do not smoke when working around diesel fuel. Open flames or sparks can cause a fire or explosion.

- a. With the start switch in the ON position, observe the position of the needle in the fuel gauge. If the needle is above the empty mark and there is fuel visible in the tank, go to Step c. If the needle is on the empty mark, go to Step b.
- b. Add the correct grade of fuel to the fuel tank, and attempt to restart the engine. If the engine will not start, go to Step 2.

NOTE: If the fuel system is completely empty, contact Unit Maintenance to prime the fuel system before attempting to start the engine.

- c. Refer the problem to Unit Maintenance for repair.

2. Engine in crank-without-inject mode:

- a. With the start switch in the ON position and the blackout light switch in STOP LIGHT, observe the crank-without-inject indicator. If the indicator is not illuminated, go to Step 3. If the indicator is illuminated, go to Step b.
- b. Refer the problem to Unit Maintenance for repair.

3. Needle valve open:

Ensure that the needle valve on the remote hydraulic tool manifold is closed. Refer to "Maintenance Features, Remote Hydraulic Tool Ports" in this section. If the needle valve is open, close the valve, and attempt to start the engine. If the needle valve is closed, go to Step 4.

4. Engine oil level low:

- a. Check the engine oil level. If the engine oil level is normal, go to Step 5. If the engine oil level is low, go to Step b.
- b. Fill the crankcase with the appropriate type of engine oil, and attempt to start the engine again. If the engine does not start, go to Step 5.

5. Restriction in air intake system:

- a. Check the air filter indicator. If red does not appear in the window, go to Step 6. If red appears in the window, go to Step b.
- b. Clean the primary air filter element, and attempt to restart the engine. If the engine does not restart, go to Step 6.

6. Cold ambient temperatures:



Do not operate the engine coolant heater in an enclosed area. The heater produces combustion gasses which may be harmful. Always start and operate the heater in a well ventilated area.

- a. If the temperature is above approximately 5°C (40°F), go to Step 7. If the temperature is between -32°C and approximately 6°C (-25°F and 40°F), go to Step b. If the temperature is below -32°C (-25°F), go to Step e.
- b. Observe the start-aid indicator after moving the start switch from OFF to ON. If the start-aid indicator illuminates for approximately 30 seconds, go to Step d. If the start-aid indicator does not illuminate, go to Step c.
- c. Reset the start-aid circuit breaker and the intake air heater circuit breaker. Observe the start-aid indicator when the start switch is moved from OFF to ON. If the start-aid indicator does not illuminate, go to Step 7. If the start-aid indicator illuminates, go to Step d.
- d. Hold start-aid switch in the ON position for three seconds, and attempt to start the engine. If the engine does not start go to Step 7.
- e. Turn the engine coolant heater ON. If the indicator in the engine coolant heater switch illuminates, go to Step g. If the indicator does not illuminate, go to Step f.
- f. Reset the engine coolant heater circuit breaker, and turn the engine coolant heater ON. If the indicator in the engine coolant heater switch illuminates, go to Step g. If the indicator does not illuminate, refer the problem to Unit Maintenance for repair.
- g. Allow the engine coolant heater to operate for 40 minutes. After a three-minute cool down period, attempt to start the engine. If the engine does not start, go to Step 7.

7. Batteries not providing sufficient voltage:

Follow the procedure given in Problem 1, Step 4.

Problem 3: Engine Runs Roughly After Starting

Probable Cause(s):

- Cold ambient temperatures
- Water in fuel
- Restriction in air intake system

1. Cold ambient temperatures:

Refer to the engine starting procedure for the appropriate air temperature, and follow the steps in the procedure to start the machine and warm it up. If the machine does not run smoothly after 10 minutes, go to Step 2.

2. Water in fuel:



Diesel fuel is combustible. Do not smoke when working around diesel fuel. Open flames or sparks can cause a fire or explosion.

- a. Check the water separator in the primary fuel filter for water or sediment. If water or sediment is not present, go to Step 3. If water or sediment is present, go to Step b.
 - b. Drain the water and sediment from the water separator into a container, and discard the fluid in accordance with local regulations. Operate the engine for several minutes. If the engine does not run smoothly after several minutes of operation, go to Step 3.
3. Restriction in air intake system:
- a. Check the air filter indicator. If red does not appear in the window, refer the problem to Unit Maintenance for repair. If red appears in the window, go to Step b.
 - b. Clean the primary air filter element, and check the engine operation. If the engine does not run smoothly, refer the problem to Unit Maintenance for repair.

Problem 4: Engine Smokes More Than Normal After Warm-up**Probable Cause(s):**

- Engine wear or mechanical problem
- Engine not at normal operating temperature
- Restriction in air intake system
- Incorrect or poor quality fuel

1. Engine wear or mechanical problem:

- a. Observe the color of the smoke. If the smoke is dark black or blue, go to Step b. If the smoke is white, go to Step 2.
- b. Report the problem of more than normal black or blue smoke to Unit Maintenance for repair.

2. Engine not at normal operating temperature:

- a. After the engine has idled for approximately five minutes, observe the engine coolant temperature gauge. If the engine coolant temperature is below normal, go to Step b. If the engine coolant temperature is normal, go to Step 3.
- b. While operating the engine at low idle, lift and lower the blade for several minutes. If the engine coolant temperature does not increase to normal, refer the problem to Unit Maintenance for repair. If the engine coolant temperature increases to normal but the white smoke remains, go to Step 3.

3. Restriction in air intake system:

- a. Check the air filter indicator. If red does not appear in the window, go to Step 4. If red appears in the window, go to Step b.
- b. Clean the primary air filter element, and check the engine operation. If the white smoke is still greater-than-normal, go to Step 4.

4. Incorrect or poor quality fuel:

- a. Check the grade of fuel which was last added to the tank. If the fuel grade is not correct for the current operating environment, go to Step b. If the fuel grade is correct for the operating environment, go to Step c.

b. Report the fuel quality problem to Unit Maintenance.

c. Report the problem of more than normal amount of white smoke to Unit Maintenance for repair.

Problem 5: Engine Overheats During Normal Operation**Probable Cause(s):**

- Low engine coolant level
- Low engine or power train oil levels
- Cooler cores blocked
- Cooling fan not operating
- Restriction in exhaust system
- Water to antifreeze ratio too high for operating environment

NOTICE

If the engine is overheating, investigate the cause immediately. Operating the machine while the engine is overheating may cause damage.

1. Low engine coolant level: **WARNING**

At operating temperature, the engine coolant is hot and under pressure. Any contact with the skin can cause severe burns. Also, cooling system additive contains alkalis. Avoid contact with the skin, eyes, and mouth. Do not open the engine coolant fill cap until the temperature of the engine coolant is below 36°C (98°F).

a. Check the coolant level. If the coolant level is normal, go to Step 2. If the coolant level is below normal, go to Step b.

b. Inspect the machine for visible coolant leaks. If leaks are found, go to Step c. If no leaks are found, go to Step d.

c. Report the location of the coolant leak to Unit Maintenance for repair.

- d. Check the engine oil level. If the engine oil level is normal, go to Step 3. If the engine oil level is low, go to Step 2. If the engine oil level is high, go to Step e.
 - e. Report to Unit Maintenance that the machine is overheating and has a possible internal coolant leak.
- 2. Low engine oil or power train oil level:**
- a. Check the engine oil level. If the engine oil level is normal, go to Step c. If the engine oil level is low, go to Step b.
 - b. Fill the crankcase with the appropriate type of engine oil, and go to Step c.
 - c. Check the power train oil level. If the power train oil level is normal, go to Step 3. If the power train oil level is low, go to Step d.
 - d. Fill power train with the appropriate type of oil, and go to Step 3.
- 3. Cooler cores blocked:**
- a. Inspect the fins of the cooler cores for debris. If debris is found, go to Step b. If no debris is found, go to Step c.
 - b. Clean the debris from the cooler cores, and go to Step c.
 - c. Look for evidence of debris in the coolant. If rust, dirt, or a green slime is present, go to Step d. If the coolant is not contaminated, go to Step 4.
 - d. Report the contamination to Unit Maintenance for repair.
- 4. Cooling fan not operating:**
- a. Inspect the cooling fan. If the cooling fan is not operating, go to Step c. If the cooling fan is operating, go to Step b.
 - b. Listen to the speed of the cooling fan when the coolant temperature is greater than 100°C (212°F). Allow the engine to cool to 90°C (194°F) or less, and listen to the fan speed. If the fan speed sounds the same, go to Step c. If the fan speed is noticeably slower, go to Step 5.

- c. Report to Unit Maintenance that the machine is overheating, and possibly has a cooling fan problem.

5. Restriction in exhaust system:

- a. Inspect the exhaust system for restrictions. If restrictions are found, go to Step b. If no restrictions are found, go to Step 6.
- b. Report the location of the restrictions to Unit Maintenance for repair.

6. Water to antifreeze ratio too high for operating environment:

If operating in a hot climate with a high concentration of antifreeze, inform Unit Maintenance that the machine is overheating during normal operation.

Problem 6: Greater-Than-Normal Fuel Consumption

Probable Cause(s):

- Restriction in air intake system
- Fuel leak
- Incorrect or poor quality fuel

1. Restriction in air intake system:

- a. Check the air filter indicator. If red does not appear in the window, go to Step 2. If red appears in the window, go to Step b.
- b. Clean the primary air filter element, and go to Step 2.

2. Fuel leak:



Diesel fuel is combustible. Do not smoke when working around diesel fuel. Open flames or sparks can cause a fire or explosion.

The fuel supply lines contain high pressure fluid. Do not use hands to inspect for fuel leaks. High pressure fluid can penetrate skin.

- a. Inspect the fuel system for visible leaks. If leaks are found, go to Step b. If no leaks are found, go to Step 3.

b. Refer the fuel leak to Unit Maintenance for repair.

3. Incorrect or poor quality fuel:

Refer the problem of greater-than-normal fuel consumption to Unit Maintenance for repair.

Problem 7: Greater-Than-Normal Oil Consumption

Probable Cause(s):

- Oil needs to be changed
- Oil leakage
- Wrong grade of oil used
- Engine wear

1. Oil needs to be changed:

- a. Determine the service meter reading at the last engine oil change or AOAP reading. If more than 250 service hours have elapsed since that reading, go to Step b. If less than 250 service hours have elapsed, go to Step 2.
- b. Deliver the machine to Unit Maintenance for performance of a 250 hour maintenance service.

2. Oil leakage:

- a. Inspect the machine for visible engine oil leaks. If leaks are found, determine the class of leak (I, II, or III), and then go to Step b. If no leaks are found, go to Step 3.
- b. Report the oil leak to Unit Maintenance for repair.

3. Engine wear:

- a. Observe the color and quantity of exhaust smoke. If the exhaust smoke is greater-than-normal and blue or black, go to Step b. If the exhaust smoke is of normal quantity and color, go to Step c.
- b. Report the greater-than-normal oil consumption and greater-than-normal amount of exhaust to Unit Maintenance for evaluation.
- c. Report the greater-than-normal oil consumption to Unit Maintenance for evaluation.

Problem 8: Low Engine Oil Pressure

Probable Cause(s):

- Low engine oil level

NOTICE

Stop the engine immediately after low engine oil pressure is detected. Operating the engine with low oil pressure may damage the engine.

1. Low engine oil level:

- a. Check the engine oil level. If the engine oil level is normal, go to Step e. If the engine oil level is low, go to Step b.
- b. Inspect for visible oil leaks. If leaks are found, go to Step d. If no leaks are found go to Step c.
- c. Fill the crankcase with the appropriate type of engine oil, and carefully watch the engine oil pressure during machine operation. Also watch for engine overheating (refer to “Problem 5, Engine Overheats During Normal Operation” in this section). If low oil pressure continues, go to Step e.
- d. Report the leaks to Unit Maintenance for repair.
- e. Report the low oil pressure to Unit Maintenance for repair.

Problem 9: Engine Stops During Operation

Probable Cause(s):

- No fuel or wrong grade of fuel
- Circuit breaker(s) tripped
- Water in fuel

1. No fuel or wrong grade of fuel:



WARNING

Diesel fuel is combustible. Do not smoke when working around diesel fuel. Open flames or sparks can cause a fire or explosion.

- a. Check the fuel level. If the machine has fuel, go to Step c. If the machine does not have fuel, go to Step b.

- b. Add the correct grade of fuel to the fuel tank, and attempt to restart the engine. If the engine will not start, go to Step 2.

NOTE: If the fuel system was completely empty, contact Unit Maintenance to prime the fuel system before attempting to start the engine.

- c. Check the grade of fuel which was last added to the tank. If the fuel grade is not correct for the current operating environment, refer the problem to Unit Maintenance. If the fuel grade is correct for the current operating environment, go to Step 2.

2. Circuit breakers tripped:

Reset the following circuit breakers: main, alternator, engine control, and transmission control. Refer to “Monitoring Systems and Cab Features, Circuit Breakers” and “Machine Features, Main Circuit Breakers” in this section. Attempt to start the engine again. If the engine will not start, go to Step 3.

3. Water in fuel:

- a. Check the water separator in the primary fuel filter for water or sediment. If water or sediment is not present, go to Step c. If water or sediment is present, go to Step b.
- b. Drain the water and sediment from the water separator into a container and discard the fluid according to local regulations. Attempt to start the engine. If the engine does not start, go to Step c.
- c. Refer the problem to Unit Maintenance for repair.

Problem 10: Engine Power Less Than Normal

Probable Cause(s)

- Restriction in air intake system
- Poor quality or wrong grade of fuel for operating conditions

1. Restriction in air intake system:

- a. Check the air filter indicator. If red does not appear in the window, go to Step 2. If red appears in the window, go to Step b.

- b. Clean the primary air filter element, and operate the machine. If the engine power is still below normal, go to Step 2.

2. Poor quality or wrong grade of fuel for operating conditions:

- a. Check the grade of fuel which was last added to the tank. If the fuel grade is not correct for the current operating environment or the fuel quality is poor, go to Step b. If the fuel grade is correct for the current operating environment, go to Step c.
- b. Report the fuel grade or quality problem to Unit Maintenance.
- c. Report the low power problem to Unit Maintenance for evaluation.

Problem 11: Transmission Will Not Go in Any Gear

Probable Cause(s):

- Parking brake is engaged
- Low power train oil pressure

1. Parking brake is engaged:

- a. Release the parking brake and go to Step b. Refer to “Problem 14: Parking Brake Will Not Release” in this manual.
- b. With the service brake depressed, move the transmission control lever to the desired gear. If the transmission does not go into gear, go to Step 2.

2. Low power train oil pressure:

- a. Check the power train oil level. If the power train oil level is low, go to Step b. If the power train oil level is normal, go to Step d.
- b. Check for visible leaks in the power train hydraulic system. If leaks are found, go to Step d. If no leaks are found, go to Step c.
- c. Add the appropriate amount and grade of oil to the power train hydraulic system, and attempt to move the machine again. If the machine does not move, go to Step d.
- d. Refer the problem to Unit Maintenance for repair.

Problem 12: Transmission Will Not Shift into High Gear in SELF-DEPLOY Mode**Probable Cause(s):**

- Machine in EARTHMOVING mode
- Drive belts too tight
- Engine power lower than normal

1. Machine in EARTHMOVING mode:

- a. With the blackout light switch in the STOP LIGHT or SERVICE DRIVE position, observe the self-deploy indicator, the blade down indicator, and the blade down alarm. If the self-deploy indicator is not illuminated, the blade down indicator is illuminated, and the blade down alarm is sounding, go to Step b. If the self-deploy indicator is illuminated, the blade down indicator is not illuminated, and the blade down alarm is not sounding, go to Step 2.
- b. Fully raise the blade and observe the self-deploy indicator, the blade down indicator and the blade down alarm. If the self-deploy indicator is not illuminated, the blade down indicator is illuminated, and the blade down alarm is sounding, go to Step d. If the self-deploy indicator is illuminated, the blade down indicator is not illuminated, and the blade down alarm is not sounding, go to Step 2.
- c. Operate the machine. If the machine still will not go into high gear, go to Step 2.
- d. Report to Unit Maintenance that the machine is stuck in the EARTHMOVING mode.

2. Drive belts too tight:

- a. Determine if the procedures for emergency drive belt tension or emergency suspension charging have been performed recently. If either of these procedures have been completed, go to Step b. If these procedures have not been completed, go to Step 3.
- b. Inform Unit Maintenance that the suspension system must be recharged as soon as possible.

3. Engine power lower than normal:

- a. Refer to "Problem 10, Engine Power Less Than Normal" in this section. If low engine power is determined not to be the problem, go to Step b.

- b. Refer the shifting problem to Unit Maintenance for repair.

Problem 13: Transmission Overheats During Normal Operation**Probable Cause(s):**

- Low power train oil level
- Engine or hydraulic system overheating

1. Low power train oil level:

- a. Check the power train oil level. If the power train oil level is low, go to Step b. If the power train oil level is normal, go to Step 2.
- b. Check for visible leaks in the power train hydraulic system. If leaks are found, go to Step d. If no leaks are found, go to Step c.
- c. Add the appropriate amount and grade of oil to the power train hydraulic system, and operate the machine again. If the power train oil continues to overheat, go to Step 2.
- d. Refer the problem to Unit Maintenance for repair.

2. Engine or hydraulic system overheating:

- a. Determine if the engine or the hydraulic system is overheating. If either or both of these systems are overheating, have the problem corrected. If neither of these systems are overheating, go to Step b.
- b. Refer the overheating problem to Unit Maintenance for repair.

Problem 14: Parking Brake Will Not Release**Probable Cause(s):**

- Service brake not engaged or transmission not in NEUTRAL
- Emergency brake release valve closed

1. Service brake not engaged or transmission not in NEUTRAL:

- a. Move the transmission control lever to NEUTRAL. Go to Step b.

- b. Cycle the parking brake ON and OFF. If the parking brake does not release, move the parking brake switch back to the ON position and go to Step 2.

2. Emergency brake release valve closed:

- a. Turn the needle valve counterclockwise, and attempt to release the parking brake. Refer to "Machine Features, Emergency Brake Release Valve" in this section. If the parking brake does not release, go to Step b.
- b. Refer the problem to Unit Maintenance for repair.

Problem 15: Service Brakes Slip

Probable Cause(s):

- Drive belt loose
- Front idlers worn

1. Drive belt loose:

- a. Observe the tension fail indicator. If the tension fail indicator is illuminated, go to Step c. If the indicator is not illuminated, go to Step b.
- b. Estimate if the drive belt is sufficiently loose to cause the brake slippage. If the drive belt is determined as the probable cause for the brake slippage, go to Step c. If the drive belt is determined not to be the likely cause of the problem, go to Step e.
- c. Perform an emergency drive belt tension procedure, and go to Step d.
- d. Inform Unit Maintenance that the suspension system must be recharged as soon as possible.
- e. Refer the brake problem to Unit Maintenance for repair.

2. Front idlers worn:

Report to Unit Maintenance that the front idlers should be checked for excessive wear.

Problem 16: Machine Drifts or Pulls to One Side During Straight Travel

Probable Cause(s):

- Drive Belt Loose

1. Drive belt loose:

- a. Observe the tension fail indicator. If the tension fail indicator is illuminated, go to Step c. If the indicator is not illuminated, go to Step b.
- b. Visually inspect the belt tension to determine if one drive belt is significantly more loose than the other. If one drive belt is determined to be significantly more loose than the other, go to Step c. If differences between the tension of the drive belts cannot be detected, go to Step e.
- c. Perform the emergency drive belt tension procedure, and go to Step d.
- d. Inform Unit Maintenance that the suspension system must be recharged as soon as possible.
- e. Refer the problem to Unit Maintenance for repair.

Problem 17: Machine Turns in Opposite Direction Than Expected During REVERSE Travel

Probable Cause(s):

- Circuit breaker tripped

1. Circuit breaker tripped:

- a. Check the operation of the gauges or kneeling switch. If the gauges and kneeling switch function properly, go to Step c. If the gauges and kneeling switch do not function properly, go to Step b.
- b. Reset the auxiliary circuit breaker and check the steering operation in REVERSE. Also check the function of the gauges and the kneeling switch. If any of these checks show a malfunction, go to Step c.
- c. Report the steering malfunction to Unit Maintenance for repair.

Problem 18: Machine Not Level on Level Ground

Probable Cause(s):

- One manual suspension lock valve closed
- Suspension system not charged correctly

1. One manual suspension lock valve closed:

- a. Examine the position of the manual suspension lock valves. If both valves are in the same position, go to Step 2. If one valve is open and one is closed, go to Step b.
- b. Place the machine in the EARTHMOVING mode, and open the manual suspension lock valve which was closed. Go to Step c.
- c. Place the machine in the SELF-DEPLOY mode, and lower and raise the machine using the kneeling switch. Go to Step d.
- d. Determine if the machine is level. If the machine is not level, go to step 2.

2. Suspension system not charged correctly:

- a. Determine if the condition of the machine interferes with the operation of the machine. If the machine cannot be operated in its current condition, go to Step b. If the machine can be operated in its current condition, go to Step c.
- b. Perform the emergency machine-leveling procedure. If the procedure restores the machine to an operational condition, go to Step c. If the procedure does not change the condition of the machine, go to Step d.
- c. Continue to operate the machine. However, deliver the machine to Unit Maintenance as soon as possible for a complete charging of the suspension system.
- d. Refer the problem to Unit Maintenance for repair.

Problem 19: Hydraulic Functions Erratic or Noisy

Probable Cause(s)

- Low oil level

1. Low oil level:

- a. Check the oil level in the hydraulic tank. If the oil level is low, go to Step b. If the oil level is normal, go to Step 2.
- b. Examine the hydraulic system for loose fittings and visible leaks. If loose fittings or leaks are found, go to Step d. If no loose fittings or leaks are found, go to Step c.

- c. Add the appropriate amount and grade of oil to the hydraulic tank. If the hydraulic functions continue to be erratic or noisy, go to Step e.
- d. Inform Unit Maintenance of the leaks, and have the leaks repaired as soon as possible.
- e. Refer the problem to Unit Maintenance for evaluation.

Problem 20: Blade Functions Exhibit Less Power Than Normal

Probable Cause(s):

- Needle valve on remote hydraulic power manifold open

1. Needle valve on remote hydraulic power manifold open:

- a. Determine if the engine is hard to start and if the engine produces black smoke after starting. If yes, go to Step b. If no, go to Step d.
- b. Examine the position of the needle valve on the remote hydraulic power manifold. Refer to "Maintenance Features, Remote Hydraulic Tool Ports" in this section. If the valve is open, go to Step c. If the valve is closed, go to Step d.
- c. Close the valve, and observe the operation of the blade functions. If the blade functions still exhibit less power than normal, go to Step d.
- d. Report the low power problem to Unit Maintenance for evaluation.

Problem 21: Blade Will Not Lower

Probable Cause(s):

- Machine in SELF-DEPLOY mode

1. Machine in SELF-DEPLOY mode:

- a. Examine the position of the self-deploy/earthmoving switch. If the switch is in EARTHMOVING, go to Step c. If the switch is in SELF-DEPLOY position, go to Step b.
- b. Move the self-deploy/earthmoving switch to EARTHMOVING position, and attempt to lower the blade. If the blade does not lower, go to Step c.

- c. Report the malfunction to Unit Maintenance for repair.

Problem 22: Lights Do Not Work

Probable Cause(s):

- Lamps burned out
- Circuit breaker(s) tripped

1. Lamps burned out:

- a. If a single indicator will not illuminate when it should, go to Step b. If multiple lamps do not illuminate when they should, go to Step 2.
- b. Report the burned-out indicator to Unit Maintenance for repair.

2. Circuit breaker(s) tripped:

- a. If the dome light and remote throttle indicator, start-aid indicator, check engine indicator, winch indicator, and crank-without-inject indicator do not function, go to Step b. If other lamps do not function, go to Step c.
- b. Reset the horn/dome circuit breaker and the start-aid circuit breaker, and retest the lamps. Refer to “Monitoring Systems and Cab Features, Circuit Breakers” and “Machine Features, Main Circuit Breakers” in this section. If the lamps still do not function, go to Step c.
- c. Report the malfunctioning lamps to Unit Maintenance for repair.

Problem 23: Cab Blower Produces Less Air Flow Than Normal

Probable Cause(s):

- Circuit breaker tripped
- Cab air filters plugged

1. Circuit breaker tripped:

- a. Determine if the blower motor operates when the blower switch is moved to ON. If the blower does not operate, go to Step b. If the blower operates, go to Step 2.
- b. Reset the air conditioning and blower motor circuit breaker. If the blower operates but still produces less air flow than normal, go to Step 2. If the blower does not operate, go to Step c.

- c. Report the blower malfunction to Unit Maintenance for repair.

2. Cab air filters plugged:

- a. Clean the external and internal cab air filters. If the blower still produces less flow than normal, go to Step b.
- b. Report the diminished air flow to Unit Maintenance for repair.

Problem 24: Recoil Alert

Probable Cause(s):

- Excess material trapped in undercarriage

NOTICE

During earthmoving operations it is possible to collapse the recoil cylinder completely. Operation of the machine in this condition may cause damage to the track belts.

1. Excess material trapped in undercarriage.

- a. If the recoil alert sounds during earthmoving operations reverse the direction of the machine to clear any excess material from the undercarriage area.
- b. If the recoil alert continues to sound, stop the machine and visually inspect tracks for blockage. Remove any excess debris from undercarriage area.
- c. Report malfunctions to Unit Maintenance for repair.

Cooling System Specifications

General Coolant Information

Water

Distilled or deionized water is recommended for use in cooling systems. Do not use hard water, tap water, or salt softened tap water in engine cooling systems. If distilled or deionized water is not available, use the cleanest water available and have the cooling system cleaned and the coolant replaced.

NOTICE

Water that does not meet the minimum acceptable limits will reduce engine service life when used in cooling systems.

Additives

Additives must be included in all coolant mixtures. Additives help prevent the formation of rust, scale, and mineral deposits. Additives protect metals from corrosion, prevent liner cavitation, and contain anti-foaming agents.

NOTICE

MIL-A-53009 Supplemental Coolant Additive (SCA) is not acceptable for use in the engine on this machine.

Glycol

Engine coolant glycol is normally either ethylene or propylene. Glycol raises the boiling point of water to help prevent boil-over, provides freeze protection, helps prevent water-pump cavitation, and reduces cylinder liner pitting.

NOTICE

For ambient temperatures requiring lower freeze protection (higher than 50 percent glycol), use ethylene glycol. do not use propylene glycol.

Proper freeze and boil protection requires the proper ratio of glycol and acceptable water. Use the following charts to determine glycol concentrations to mix with acceptable water.

Percentage of Propylene Glycol	Freeze Protection	Anti-Boil Protection
30%	-15°C (-5°F)	102°C (216°F)
40%	-23°C (-9°F)	104°C (219°F)
50%	-37°C (-35°F)	106°C (223°F)

Percentage of Ethylene Glycol	Freeze Protection	Antiboil Protection
30%	-15°C (-5°F)	104°C (219°F)
40%	-24°C (-11°F)	106°C (223°F)
50%	-37°C (-35°F)	108°C (226°F)
60%	-57°C (-71°F)	111°C (232°F)

Coolant Recommendations

Preferred—Caterpillar Extended Life Coolant (ELC) or a commercial ELC that meets the Caterpillar specification (EC-1).

Acceptable—A Caterpillar Diesel Engine Antifreeze/Coolant (DEAC) or a commercial heavy-duty coolant/antifreeze that meets ASTM D4985, ASTM D5345, or MIL-A-46153 specifications.

Unacceptable—Any high silicate coolant that is classified as meeting ASTM D3306.

NOTICE

Most commercial engine coolant/antifreeze is formulated for gasoline engine applications and have a high silicate content. High silicates are conducive to cylinder liner cavitation and corrosion. Caterpillar does not recommend high silicate coolant/antifreeze.

NOTICE

Never add coolant to an overheated engine; allow the engine to cool first. Do not add coolant too quickly. Filling the cooling system at over 19 L (5 U.S. gal) per minute can create air pockets in the cooling system. Engine damage can result.

NOTE: MIL-A-4615 Antifreeze can be mixed with the Caterpillar ELC supplied in the DEUCE.

When filling or adding coolant to the system, premix the coolant solution prior to pouring it into the cooling system. Pure, undiluted glycol will freeze at -23°C (-0°F). Use a coolant solution in a range which will provide protection to the lowest expected outside (ambient) temperature and provide the required boil-over protection.

Fuel Specifications

Fuel Recommendations

NOTICE

Fill the fuel tank at the end of each day of operation to remove moist air and prevent condensation. Maintain a constant level in the tank (near the top) to avoid drawing moisture into the tank as the level decreases.

Do not fill the tank to the top. Fuel expands as it warms, and may overflow.

Do not fill fuel filters with fuel before installing them. Contaminated fuel causes accelerated wear to fuel system parts.

Use only the fuel recommended in this section of this manual. Fuel grades recommended for use in Caterpillar diesel engines are: No.2-D diesel fuel with low sulfur (0.05 percent maximum), or regular sulfur (0.5 percent maximum). No.1 grades are acceptable.

The table lists worldwide fuel standards which meet Caterpillar requirements.

WORLDWIDE FUEL SPECIFICATIONS FOR DIESEL ENGINES	
Specifications	Designated Fuels
American Standards (U.S.) ASTM D975 ASTM D396 ASTM D2880	No. 1-D No. 2-D fuel oil No. 1 fuel oil and No. 2 fuel oil No. 1-GT fuel for the gas turbine engine and No. 2-GT fuel for the gas turbine engine
British Standards BS 2869	Class A1 diesel fuel Class A2 diesel fuel Class B1 diesel fuel Class C2 fuel for heating and Class D fuel for heating
German Standards DIN 51601 DIN 51603	Diesel fuel
Australian Standards AS 3570	Automotive diesel fuel
Japanese Standard JIS K2204	Type 1 (spl) fuel oil Type 1 fuel oil Type 2 fuel oil Type 3 fuel oil Type 3 (spl) fuel oil
U.S. Government W-F-800C W-F-815C	U.S. DF-1 diesel fuel U.S. DF-2 diesel fuel U.S. DF-20 diesel fuel FS-1 fuel oil for heating and FS-2 fuel oil for heating
U.S. Military Standards MIL-L-16884G	Marine oil

Aviation kerosene-type fuels meeting acceptable limits may also be used as an engine fuel. The table below lists some of the acceptable kerosene-type fuels.

ACCEPTABLE KEROSENE FUELS	
ASTM D 1655-80	Aviation Turbine Fuel (JET A-1)
MIL-T-83133B	Aviation Turbine Fuel (JP-8) (NATO Code No. F-34)
W-F-800F1	Grade DF-A (Arctic)

Lubricant Specifications

Engine Lubricant Specifications

Diesel Engine Oils

The performance of commercial diesel engine oils is based on API categories. These API categories are developed to provide commercial lubricants for a wide variety of diesel engines that operate at various conditions.

If Caterpillar DEO (multi-grade) is not used, use only the following commercial oils:

Preferred — API CG-4

Allowed — API CF-4

Oils which meet specification MIL-L-2104 are acceptable for use in the engine on this vehicle. These oils can be mixed with the preferred and allowed oils described above.

Caterpillar Transmission/Drive Train Oil (TDTO) (TO-4)—Hydraulic System, Power Train, Offset Arms, Rear Idlers, Midrollers

Caterpillar TDTO TO-4 is balanced to give maximum frictional material life in power shift transmissions. TO-4 oil specifications include frictional and gear wear requirements. TO-4 oil is offered in several viscosity grades, including SAE 50, for maximum component life at high ambient temperatures and heavy duty cycles.

NOTICE

TO-4 is formulated for transmissions and drive trains only. Using TO-4 in an engine would result in shortened engine life.

Do not use engine oils for lubricating transmissions or drive trains. Failure to follow this recommendation can cause shortened transmission life due to material incompatibility and inadequate frictional requirements for disk materials.

NOTE: Use of a single viscosity grade MIL-L-2140 oil in the Hydraulic System, Power Train is acceptable. Single viscosity oils which meet MIL-L-2104 can be mixed with the Caterpillar TDTO oils

Caterpillar does not currently offer multigrade oils for use in transmissions. Multigrade oils which use high molecular weight polymers as viscosity index improvers lose their viscosity effectiveness (permanent and temporary shear), and are therefore not recommended for transmission and drive train compartments. The Caterpillar TO-4 specification includes a test for multigrade oil shear stability; oils that meet this specification may be available in the future.

Lubricating Grease

The National Lubricating Grease Institute (NLGI) classifies grease, based on ASTM D217-68 Worked Penetration characteristics. Grease characteristics are given a defined consistency number.

Molybdenum Grease: NLGI No. 2 Grade contains three percent molybdenum disulfide to five percent molybdenum disulfide. This grease is a multipurpose grease with an operating temperature range from -28°C to 149°C (-18°F to 300°F).

Water and Temperature Resistant Grease: NLGI No. 2 Grade is highly resistant to water. This grease meets the ASTM D-1264 "Water Washout Test" requirement and resists low temperatures and high temperatures. This grease has a starting torque at -40°C (-40°F) and is not fluid at 316°C (600°F).

Lubricant Viscosities and Refill Capacities

Lubricant Viscosities

LUBRICANT VISCOSITIES FOR AMBIENT (OUTSIDE) TEMPERATURES ⁽¹⁾					
Compartment or System	Oil Viscosities	°C		°F	
		Min	Max	Min	Max
Engine Crankcase DEO	SAE 0W20	-40	+10	-40	+50
	SAE 15W40	-10	+50	+15	+122
Power Train, Midrollers, Rear Idlers TDTO	SAE 0W20 (SPC) ¹	-40	+10	-40	+50
	SAE 30	0	+35	+32	+95
	SAE 40	+5	+45	+41	+113
	SAE 50	+10	+50	+50	+122
Hydraulic System, Suspension Cylinders, Recoil Cylinders TDTO	SAE 0W20 (SPC) ¹	-40	+10	-40	+50
	SAE 10W	-20	+40	-4	+104
	SAE 30	+10	+50	+50	+122
Winch Gearbox TDTO	SAE 0W20 (SPC) ¹	-40	+10	-40	+50
	SAE 40	+5	+45	+41	+113
	SAE 50	+10	+50	+50	+122
Cab/Radiator Tilt Pump TDTO	SAE 0W20 (SPC) ¹	-40	+50	-40	+122

¹ Special oils with synthetic base stocks that do not contain polymer viscosity index improvers. The high viscosity index of the "synthetic" oils provide natural multiviscosity properties.

Refill Capacities

REFILL CAPACITIES (APPROXIMATE)			
Compartment or System	Liters	U.S. Gal.	Imperial Gal.
Cooling System	42	11	9.2
Fuel Tank	341	90	75
Engine Oil With Filter	35	9.2	7.7
Power Train	152	40	33.3
Hydraulic Tank	72	19	15.8
Midrollers	.125	4.2 oz	4.4 oz
Winch Gearbox	1.1	.3	.2
Rear Idlers	1.5	.4	.3
Windshield Washer Bottle	3.8	1.0	.8
Cab/Radiator Tilt Pump	1	.26	.22

Lubrication Chart

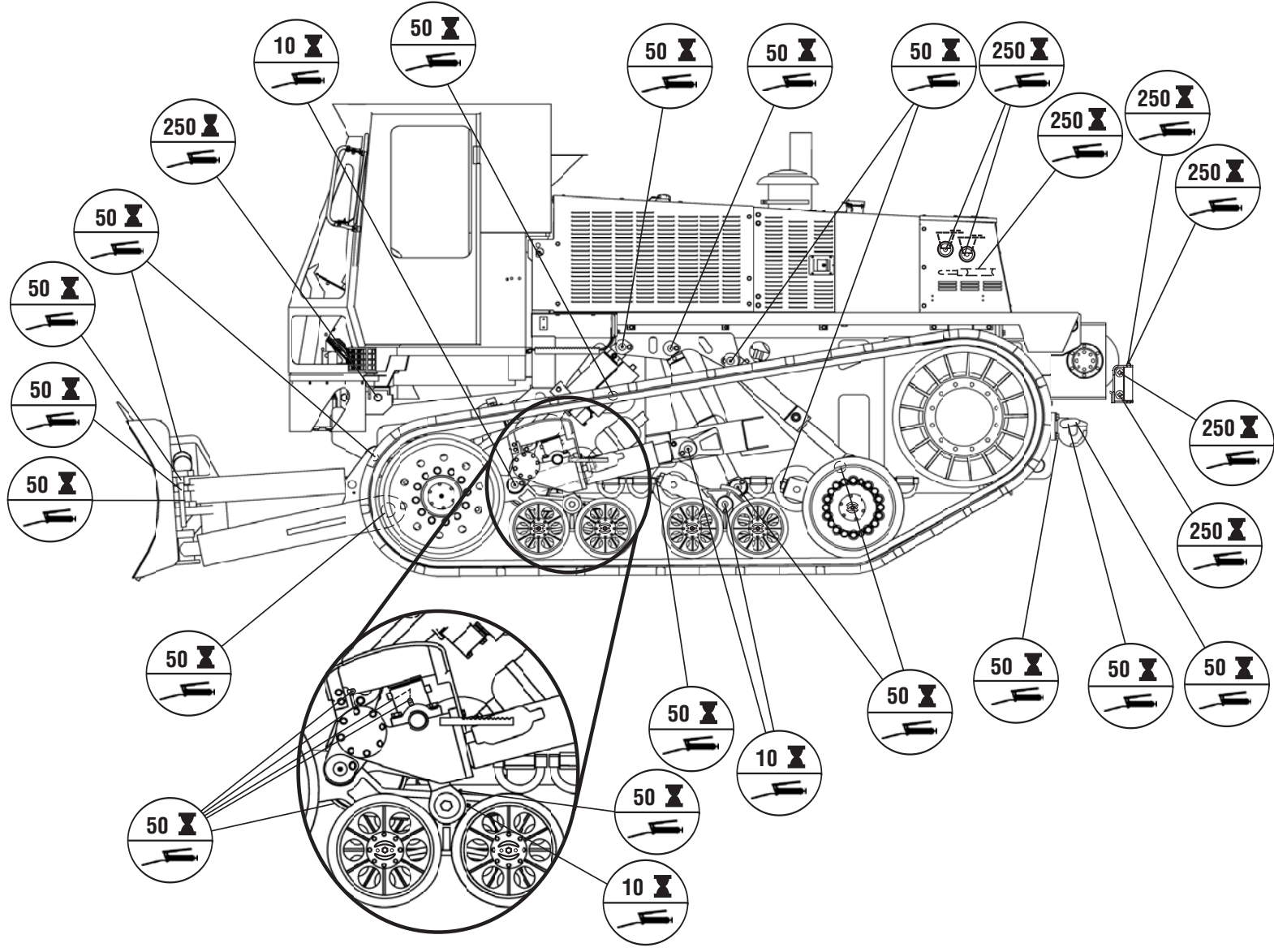

Maintenance Intervals

When Required

Engine Air Intake System—Service Filter..... 106
 Cab Air System—Service Filters 108
 Radiator—Clean Radiator..... 110
 Circuit Breakers—Reset 110
 Windshield Wipers—Replace 111
 Windshield Washer Fluid—Refill 111

10 Service Hours or Daily

Walk-Around Inspection—Inspect Machine 112
 Seat Belt—Inspect for Damage 118
 Engine Crankcase—Check Oil Level..... 118
 Hydraulic Tank—Check Oil Level 119
 Power Train Oil—Check Oil Level 120
 Radiator—Check Coolant Level 120
 Water Separator—Drain Water/Sediment..... 121
 Indicators, Gauges, Horns and Lights—
 Check Operation 121
 Brakes—Check Operation 122
 Backup Alarm—Check Operation 123
 Undercarriage—Lubricate..... 123
 Undercarriage—Check Oil Level 124 ■
 Undercarriage—Check Balance 124

50 Service Hours or Weekly*

Undercarriage—Lubricate 125
 Undercarriage—Check Oil Level 125 ■
 Pintle Hook—Lubricate 126
 Blade—Lubricate 126

250 Service Hours or 3 Months

Cab Pins—Lubricate..... 127
 Winch—Check Hooks, Cable/Lubricate/..... 127
 Doubling Block..... 128
 Castor Wheel Assembly 128
 Engine Coolant Heater—Check Operation..... 128

*First perform maintenance items from previous service intervals.

When Required

You must first read and understand the warnings and instructions contained in this manual before performing any operation or maintenance procedures.

Engine Air Intake System

Service Filter Elements

WARNING

If nuclear, biological, or chemical (NBC) exposure is suspected, all filter media should be handled by personnel wearing protective equipment. Consult the unit NBC officer or NBC noncommissioned officer for appropriate handling or disposal procedures.

NOTICE

Service the air intake filters only with the engine stopped, or engine damage could result.

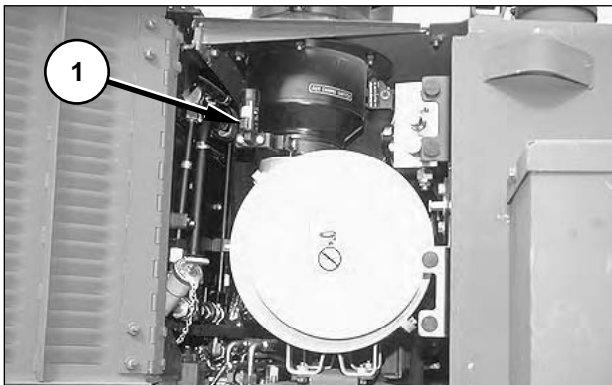

Air Filter Service Indicator (1)—Service the air intake filter elements when red appears in the viewing window or when the arrow is at the 25 inches position. Reset the indicator by pushing up on the button.

Service Primary Element

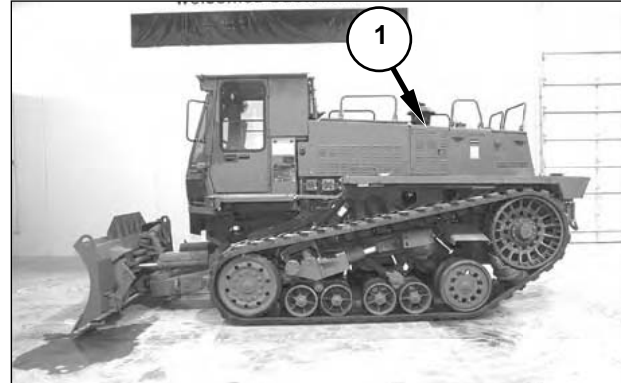

1. Open air intake compartment access door (1) on the left side of the machine.

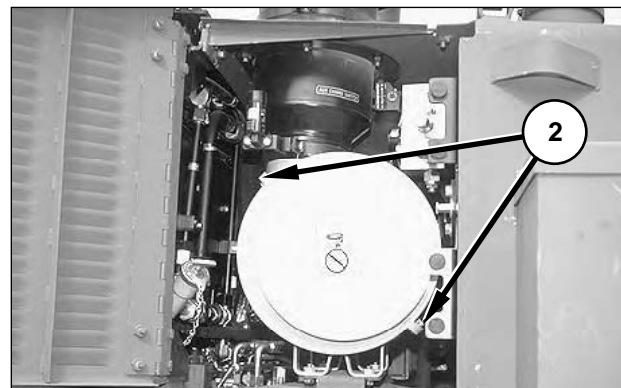

2. Open two latches (2), and remove the air cleaner cover.

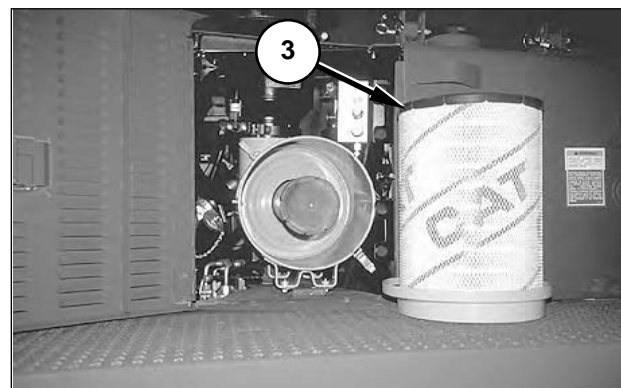

3. Remove primary filter element (3) from the air cleaner housing.
4. Clean the inside of the housing.
5. Clean and inspect primary element (3).

NOTE: For cleaning procedures, refer to “When Required, Cleaning Primary Element,” in this section.

6. Install the clean primary element.
7. Clean and install the air cleaner cover. Close latches (2).
8. Reset the air filter service indicator.
9. Close air intake compartment access door (1).

NOTE: If the air filter service indicator shows a restriction after cleaning the primary element, have Unit Maintenance install a new primary and secondary element.

Inspect Secondary Element

NOTICE

Never attempt to clean and reuse a secondary filter element.

The secondary filter element should be replaced at the time the primary element is serviced for the third time.

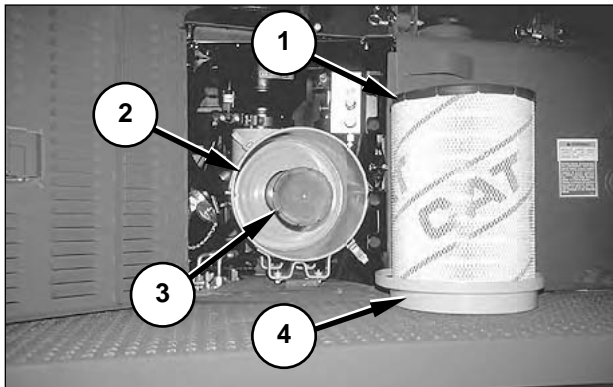

1. Remove air cleaner housing cover (4) and primary element (1).
2. Remove secondary element (3).
3. Cover the air inlet opening. Clean the inside of air cleaner housing (2).
4. Inspect the gasket. Have Unit Maintenance replace the gasket if it is damaged.
5. Inspect secondary element (3) for plugging and damage.

NOTE: If the secondary element is plugged with dust or damaged, have Unit Maintenance replace the element.

6. Uncover the air inlet opening. Install secondary element (3).
7. Install primary element (1). Install cover (4).

Cleaning Primary Element

NOTICE

Do not clean the filter element by bumping or tapping the element. Do not use a filter element with damaged pleats, gaskets, or seals. Engine damage can result.

Make sure the cleaned filter element is completely dry before installing it into the filter housing. Water remaining in the element can cause false indications of contamination in oil sampling test results.

NOTE: Primary filter elements can be cleaned with pressure water at a maximum of 280 kPa (40 psi), or detergent washing.

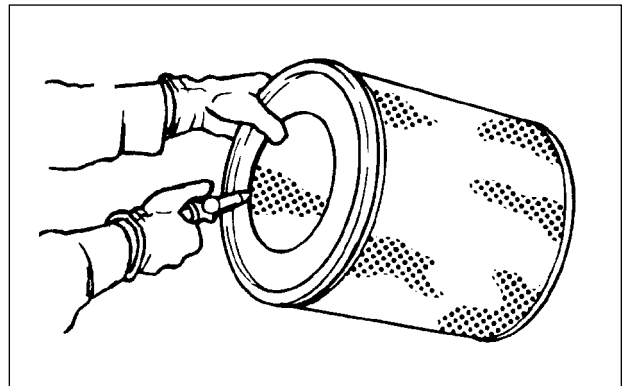

1. Direct water along the pleats inside and outside the filter element.

NOTE: If the element is washed in warm water and nonsudsing household detergent, rinse the inside and outside of the pleats with clean water, and air dry the filter element completely.

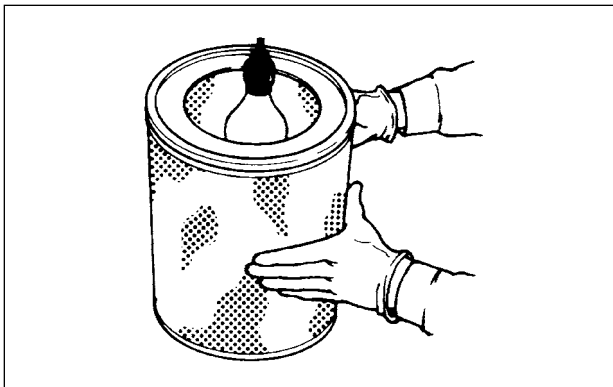

2. Use a light source to inspect the filter elements after cleaning. Do not use a filter element with damaged pleats, gaskets, or seals.

NOTE: If the filter element is damaged, have Unit Maintenance replace the element.

3. Wrap and store the clean filter elements in a clean, dry place.

Cab Air System

WARNING

If nuclear, biological, or chemical (NBC) exposure is suspected, all filter media should be handled by personnel wearing protective equipment. Consult the unit NBC officer or NBC non-commissioned officer for appropriate handling or disposal procedures.

Service Filter Elements

Clean the filter elements when a significant reduction in air circulation is noticed. Maximum performance can not be achieved unless the filter is kept clean.

Before servicing the filters, switch off the blower, close all windows, and forcibly close the door. The resulting back pressure will dislodge most of the loose dirt from the outside of the filters.

NOTE: In humid conditions, such as often occurs in the early morning, do not switch on the blower prior to servicing the filter. Damp particles drawn into the filter may be difficult to remove when cleaning.

External Filter

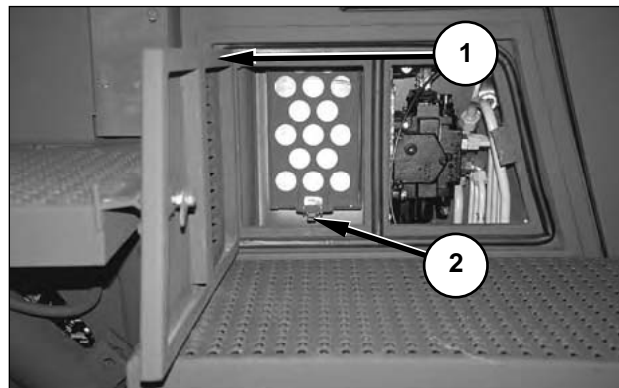

1. Open access door (1) on the right side of the cab.
2. Open latch (2) at the bottom of the filter bracket and remove the bracket.

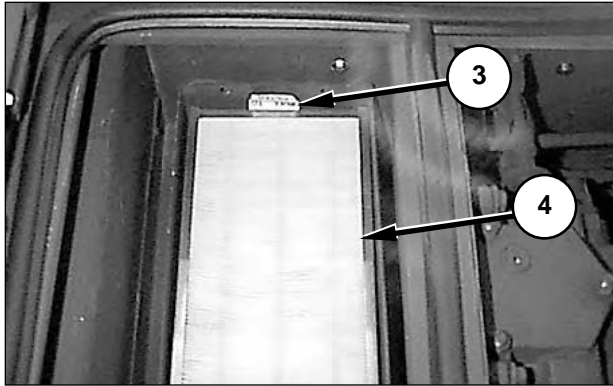

3. Remove air filter element (4) by pulling on tab (3) at the top or bottom of the filter.

4. Inspect filter element (4) for plugging or damage.

NOTE: If filter element (4) is excessively dirty or damaged, notify Unit Maintenance that the filter element must be cleaned or replaced.

5. Clean the filter chamber with a damp cloth.

6. Install filter element (4).

7. Install the filter bracket and close latch (2) at the bottom of the filter bracket.

8. Close access panel (1).

Internal Filter

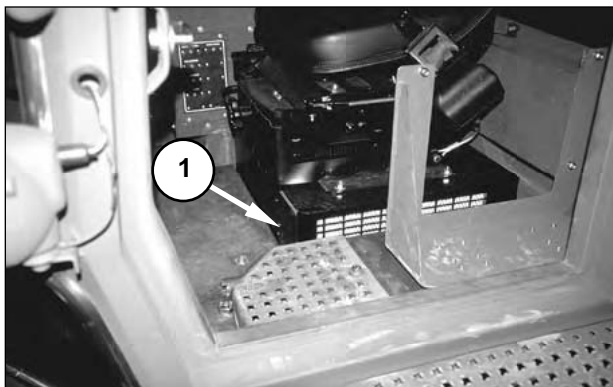

1. Remove bolt and open access door (1) at the front of the blower assembly.

2. Remove the filter elements.

NOTE: There are two filter elements installed together.

3. Inspect the filter elements for plugging or damage.

Radiator

Clean

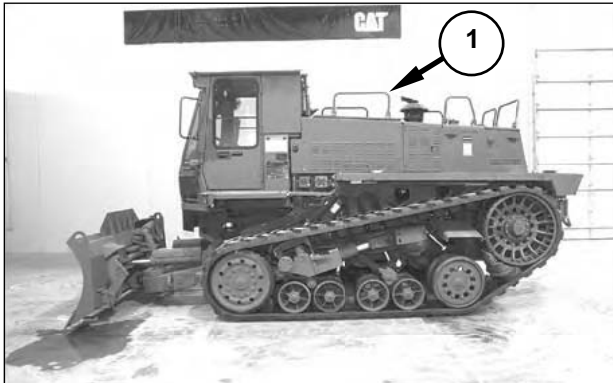

1. Lift the radiator guard by pulling up sharply on grab rail (1).

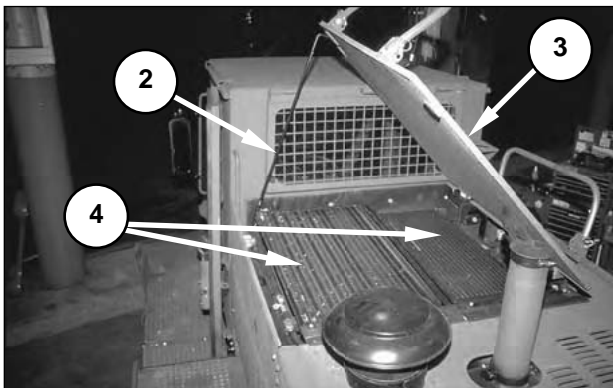

2. Prop radiator guard (3) open with prop rod (2).
3. Clean any accumulated debris from the top of cores (4).

NOTICE

Do not brush the radiator with your hands, or another object, or you may bend the cooling fins.

4. Return prop rod (2) to its storage location.
5. Lower radiator guard (3), pressing down on it firmly to secure the guard in place.

Circuit Breakers

Reset

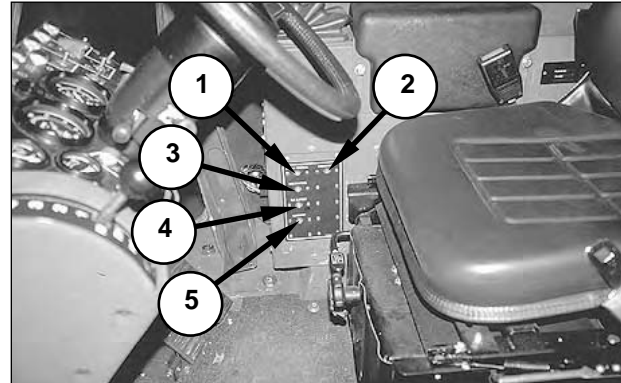

Press the button to reset the following circuit breakers on the front circuit breaker panel:

- (1) Engine Control—20 Amps.
- (2) Dome/Horns—15 Amps.
- (3) Transmission Control—20 Amps.
- (4) A/C Blower—15 Amps.
- (5) Auxiliary—15 Amps.

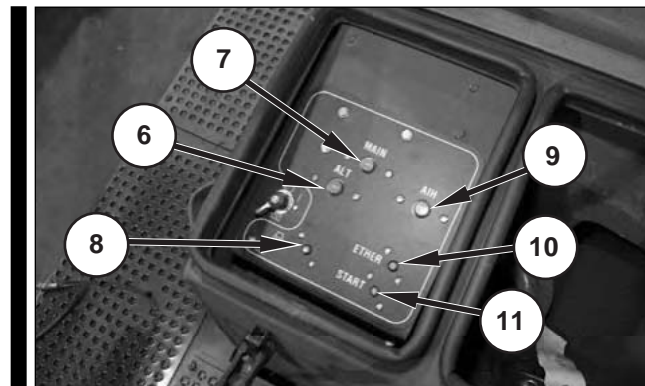

Press the button to reset the following circuit breakers on the main circuit breaker panel:

- (6) Main—105 Amps
- (7) ALT (Alternator)—105 Amps
- (8)  (Engine Coolant Heater)—30 Amps
- (9) AIH (Intake Air Heater)—80 Amps
- (10) Start—10 Amps
- (11) Ether—15 Amps

Windshield Wiper

Replace Blade

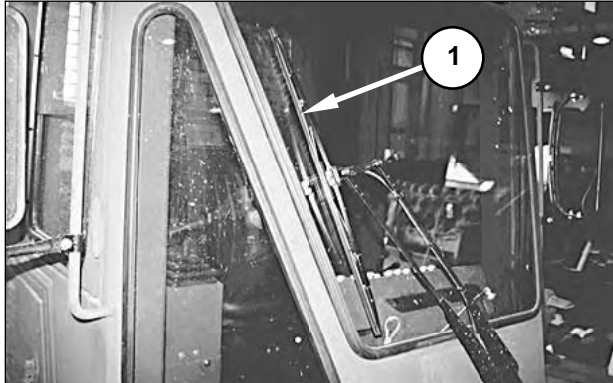

When the windshield wiper no longer wipes the window clean, inform Unit Maintenance that wiper blade (1) needs to be replaced.

Windshield Washer Fluid

Refill Container

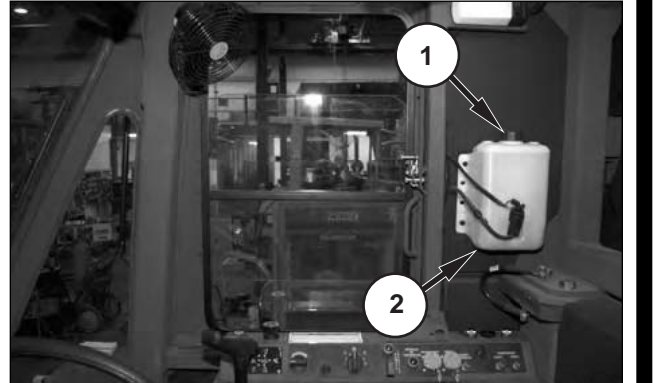

1. Remove cap (1).
2. Fill bottle (2) with windshield washer solvent.

NOTE: The capacity of the windshield washer container is 3.79 L (1 U.S. gal).

3. Reinstall cap (1).

Every 10 Service Hours or Daily

You must first read and understand the warnings and instructions contained in this manual before performing any operation or maintenance procedures.

Walk-Around Inspection

When checking the specific components or areas on the machine, be alert for oil or fuel leaks, loose or missing fasteners, filler caps, or identification/safety plates, and cracked or bent components. Have Unit Maintenance make any needed repairs before operating the machine.

NOTE: Army operators should perform the Operator's Preventive Maintenance Checks and Services (OPMCS) before operating the machine. Refer to Appendix A in this manual for the check list.

Undercarriage

Clean away any dirt and debris that has accumulated in the undercarriage area, then inspect the following components.

Drive Belts

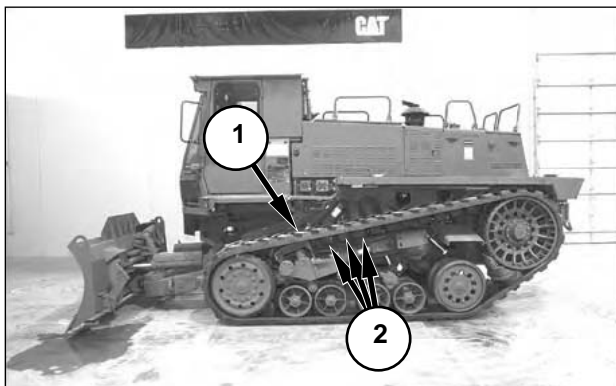

Have Unit Maintenance replace belts (1) if any of the following conditions are met:

- More than two guide blocks (2) in a row are missing.
- More than 12 guide blocks (2) (one quarter of the total number) are missing.
- Belt (1), including internal cables, is severed more than 40 percent of the width of the track, at any location.

Midrollers and Idlers

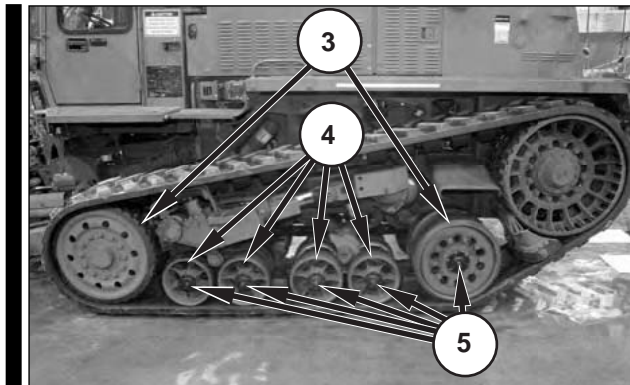

Have Unit Maintenance repair or replace idlers (3) or midrollers (4) if the following conditions are met:

- Oil is leaking enough to form drops.
- Oil level is low or not visible in sight gage (5) on outside midroller or rear idler.
- More than 50 percent of the rubber is missing from any midroller (4) or more than 25 percent of the rubber is missing from any idler (3).
- There are loose or missing bolts.

Swing Arms

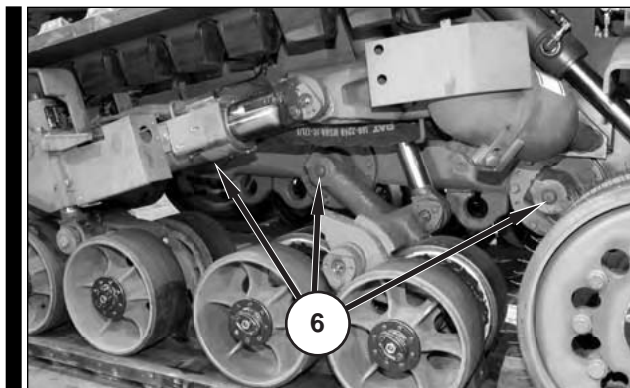

Check swing arm pivot joints (6) for loose or missing bolts.

Cylinders, Accumulators and Hoses

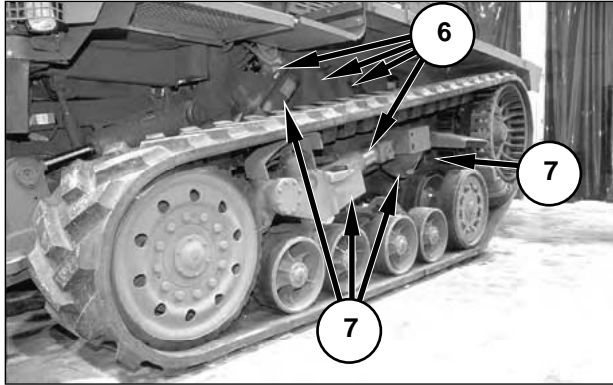

Inspect suspension cylinders (6), accumulators (7), and visible hoses for leaks large enough to form drops. Use a soft cloth to remove any dirt from the cylinder rods. Check for loose or missing fasteners. If leaks or loose or missing fasteners are found on any component, inform Unit Maintenance.

Pin Retention Bolts

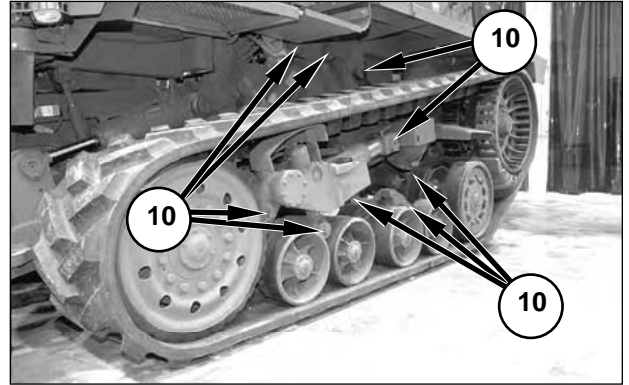

Inspect undercarriage pins (10) for loose or missing retention bolts. Inform Unit Maintenance if any loose or missing retention bolts are found.

Drive Wheels and Scraper Bars

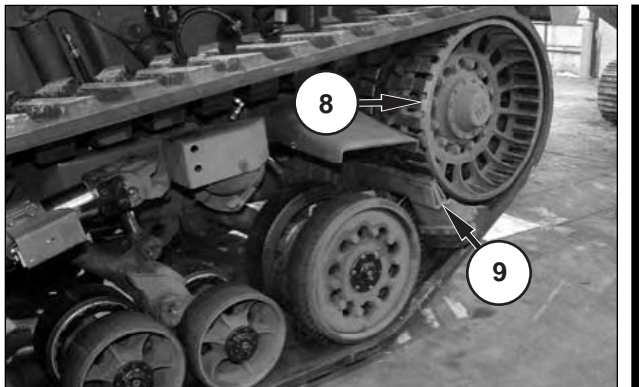

Inspect drive wheel (8). Have Unit Maintenance repair or replace the drive wheel/hub if any of the following conditions are met:

- More than two drive slats in a row, more than four in a group of ten, or more than six total, are missing from a single drive wheel.
- Oil is leaking from the hub severely enough to form drops.
- There are loose or missing mounting bolts.

Inspect scraper bars (9) for damage and loose or missing fasteners. Notify Unit Maintenance to repair or replace the scraper bar if it is bent, the rubber flaps are missing, or if any bolts are loose or missing.

Belt Guides

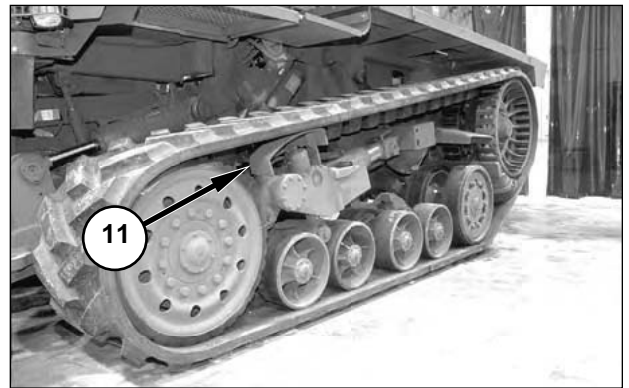

Inspect belt guides (11) for wear and loose or missing bolts. Notify Unit Maintenance if the belt guides are worn enough for holes to form, or if the bolts are loose or missing.

Dozer Blade

Cutting Edge

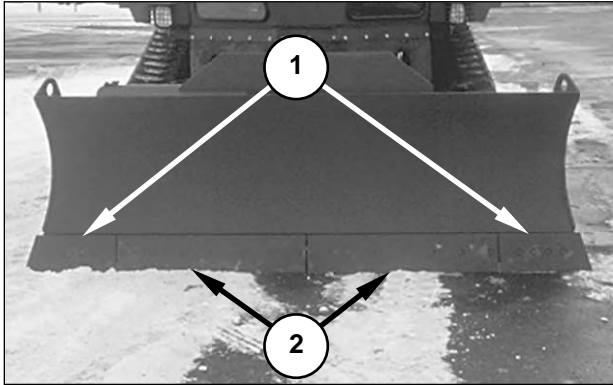

Inspect cutting edges (2) and end bits (1) for wear and damage. Have Unit Maintenance replace the cutting edge or end bits if the adapters are exposed to wear, or if they are broken or cracked. Have Unit Maintenance repair any loose or missing fasteners.

Hydraulic Cylinders and Hoses

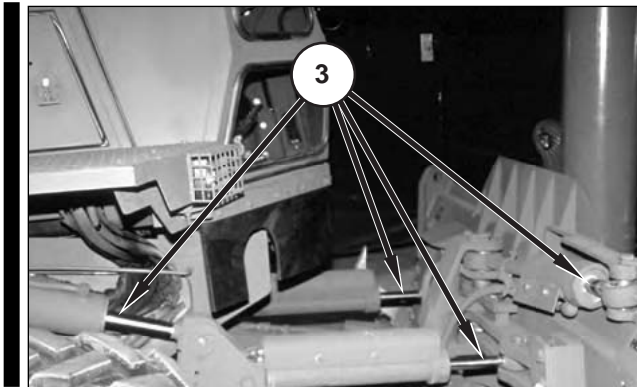

Inspect hydraulic cylinders (3) and hoses. Have Unit Maintenance repair or replace any hydraulic cylinder or hose that is leaking enough oil to form drops. Have Unit Maintenance repair any loose or missing fasteners.

Back Rippers

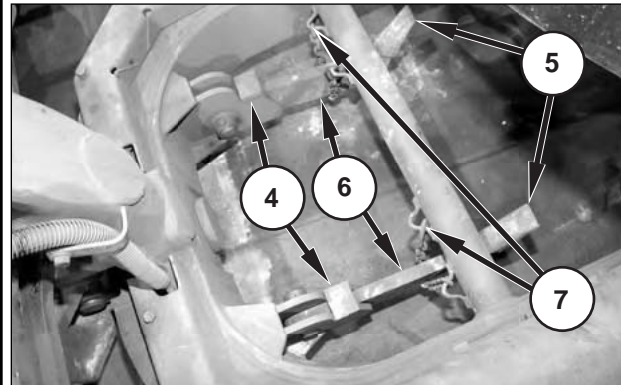
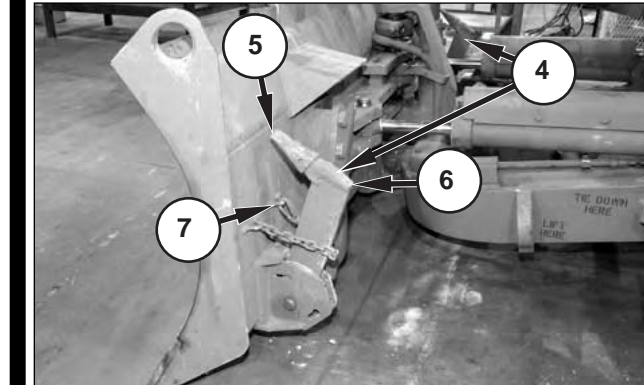

Inspect the four back rippers (4) for wear and damage. Have Unit Maintenance replace any missing ripper tips (5), or tips that have worn through to the adapter. Have Unit Maintenance replace any worn or cracked shanks (6) and loose or missing chains (7).

Winch

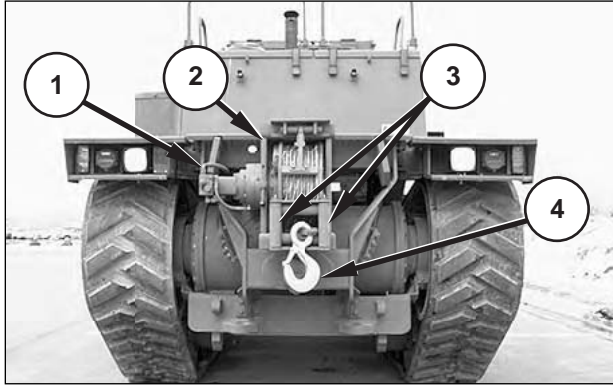

Inspect winch hydraulic motor (1) and any visible hydraulic hoses at the rear of the tractor for leaks. Have Unit Maintenance repair or replace the winch motor or hose if oil is leaking enough to form drops.

Check winch frame (2) for cracks, bends or loose or missing fasteners. Check for cracked or bent rollers (3) on the fairlead. Have Unit Maintenance repair or replace the winch if any defects are discovered.

Check the safety latch, if equipped, on hook (4) for cracks, bends, or a loose or missing hinge spring. Have Unit Maintenance repair or replace the safety latch if any defects are discovered.

Power Train

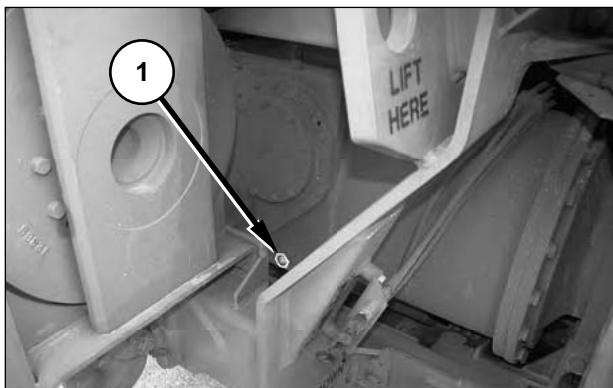

Check the power train oil level in sight glass (1). Refer to “Every 10 Service Hours or Daily, Power Train, Check Oil Level” in this section.

Check for leaks large enough to form drops on all visible components. Report any leaks found to Unit Maintenance for repair.

Radiator

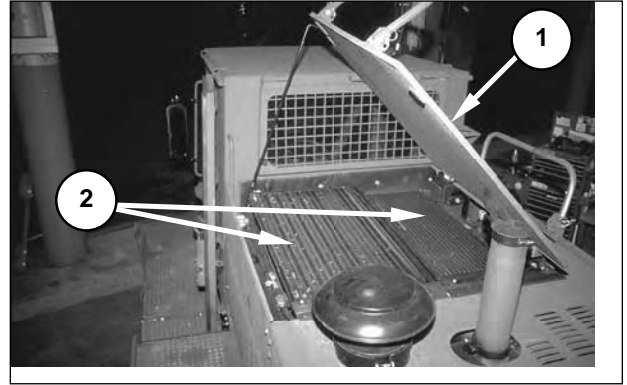

Raise radiator guard (1), and inspect cooler cores (2). Clean accumulated debris from the top of the cooler cores. If debris is lodged between the cooling fins, inform Unit Maintenance that the cooler cores need to be cleaned.

NOTICE

Do not brush the radiator with your hands or another object or you may bend the cooling fins.

Coolant Reservoir

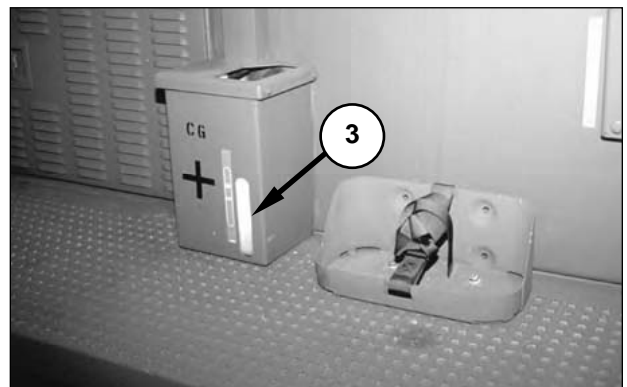

Check the coolant level in coolant reservoir (3). Refer to “Every 10 Service Hours or Daily, Radiator, Check Coolant Level” in this section.

Air Filter Compartment

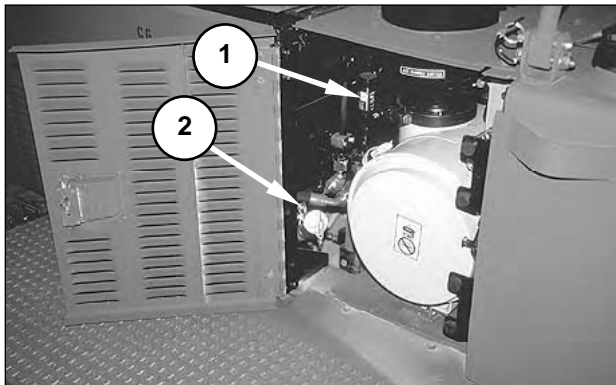

Inspect the following components in the air filter compartment:

- Check engine oil level (2). Refer to “Every 10 Service Hours or Daily, Engine Crankcase, Check Oil Level” in this section.
- Check air filter service indicator (1). Refer to “When Required, Engine Air Intake System” in this section.
- Check for oil leaks large enough to form drops on any hoses and components in view.

Oil Filter Compartment

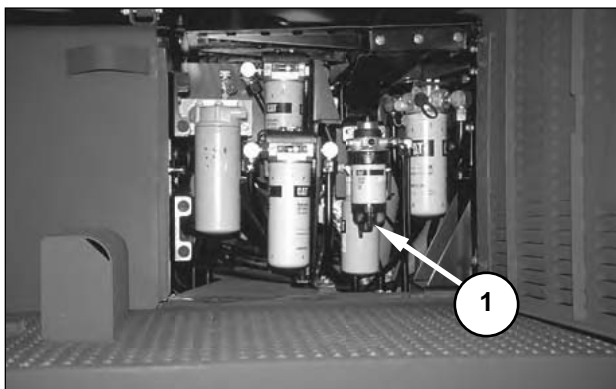

Check the following items in the oil filter compartment:

- Check for leaks large enough to form drops at each filter and hose visible in the compartment.
- Check fuel and water separator (1) for water and sediment.

Hydraulic Oil Tank

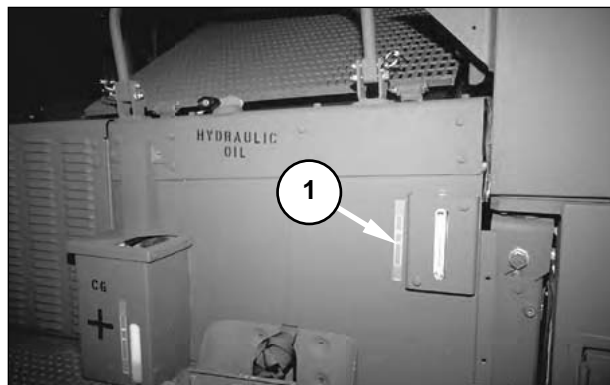

Check for leaks large enough to form drops. Check the hydraulic oil level in the tank. Refer to “Every 10 Service Hour or Daily, Hydraulic Oil Tank, Check Oil Level” in this section.

NOTE: Use the marks on decal (1) to determine the correct oil level in the tank. Do not use the marks on the sight glass.

Cab

Windows and Wiper Blades

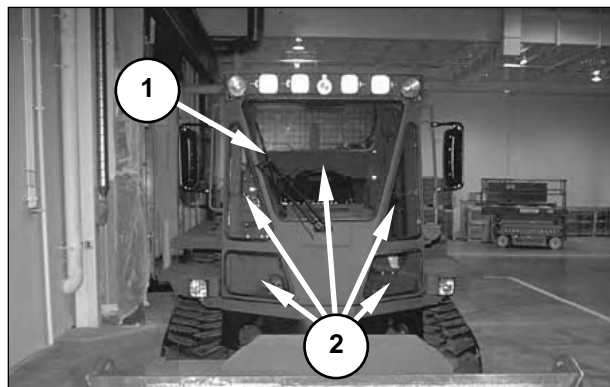

Keep windows (2) clean to ensure maximum visibility. Use a ladder, or other suitable device, to access the upper windows for cleaning. Clean the lower windows from the ground. Use commercially available cleaning solutions to clean the window.

Check to be sure wiper blades (1) are installed and are not damaged.

Remove any build-up of dirt, trash or debris from the cab interior. Keep the cab interior clean.

Mirrors

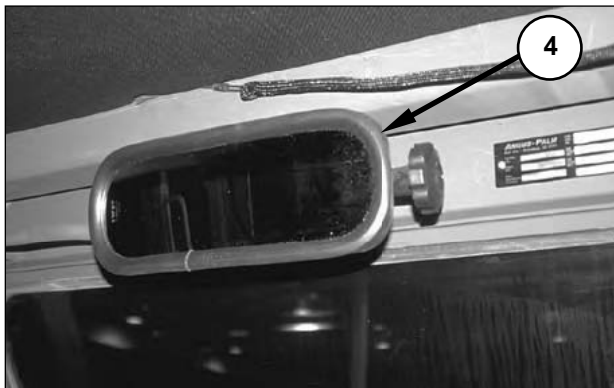
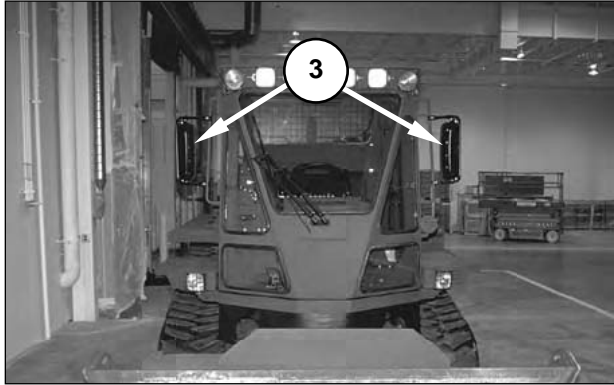

Inspect the side mirrors (3) and rear view mirror (4). Have Unit Maintenance replace any damaged or missing mirrors. Be sure to check the mirror adjustment to get maximum visibility while seated in the cab.

Gauges

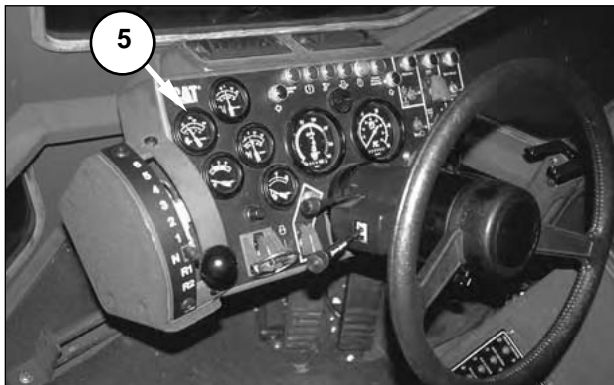

Inspect all gauges on instrument panel (5). Have Unit Maintenance repair or replace any unreadable gauges.

Windshield Washer Fluid Bottle

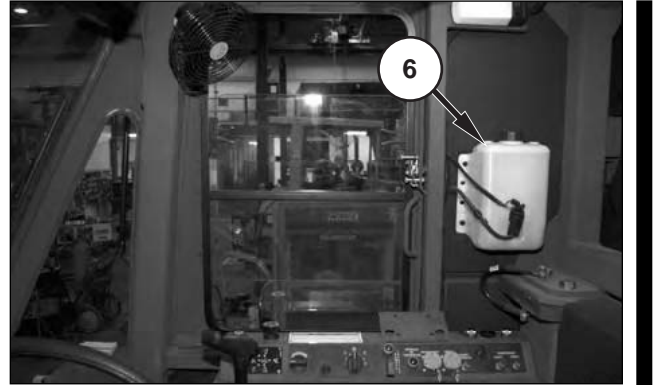

Refill windshield washer bottle (6) if the level is low.

Seat Belt

Inspect for Wear or Damage

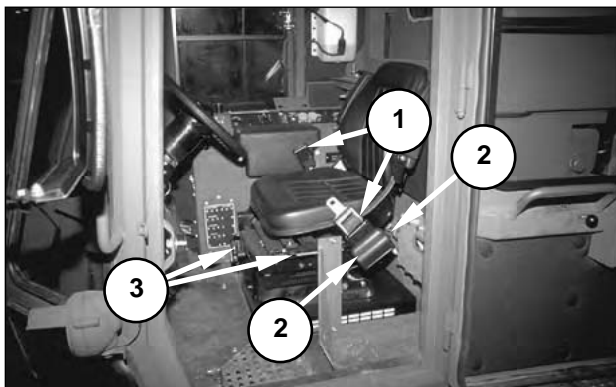

Seat belt (1) and mounting hardware (2) must be inspected for wear, damage and expiration before the machine is operated. Have Unit Maintenance replace the belt or mounting hardware if worn, damaged or expired.



The seat belt must be replaced after three years of use, regardless of appearance. Tag (4) is sewn into the belt. Fully extract the belt and check the date on the tag. If the date on the tag is more than three years prior to the current date, report the seat belt to Unit Maintenance for replacement.

Adjust seat position (3) so that all of the machine's controls are easy to reach.

Engine Crankcase

Check Oil Level



1. Open air filter compartment door (1) on the left side of the machine.

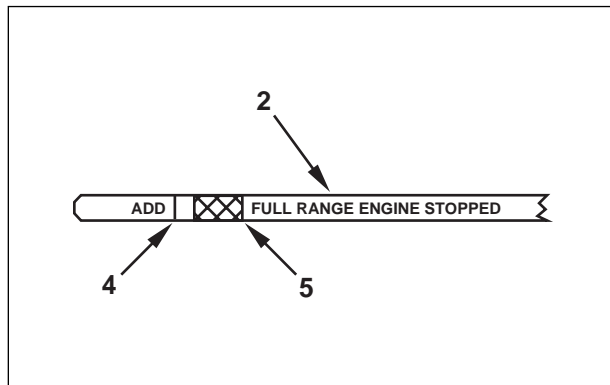
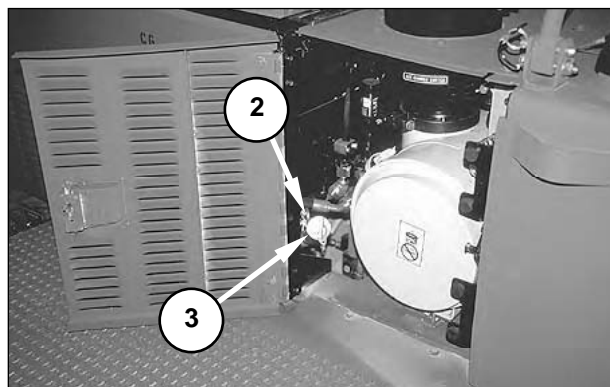

2. Maintain the oil level between ADD (4) and FULL (5) marks on dipstick (2) with the engine stopped. The oil level should be checked when the engine is cold.

NOTE: When operating on severe slopes, the oil level in the engine must be at the FULL mark on dipstick (2) when the machine is on level ground.

3. Remove oil fill plug (3) and add oil, if necessary.
4. Clean and install oil fill plug (3).
5. Close air intake compartment door (1).

Hydraulic Tank

Check Oil Level

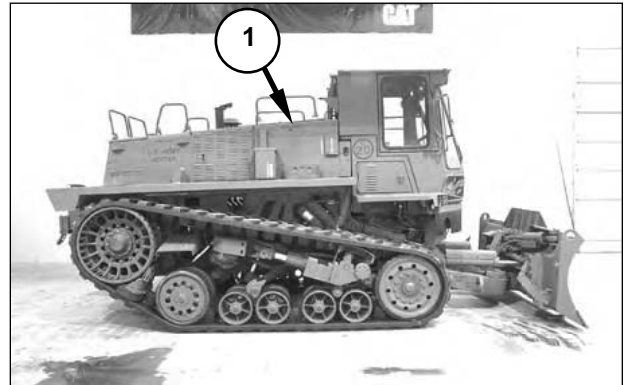

Hydraulic oil tank (1) is located on the right side of the machine.

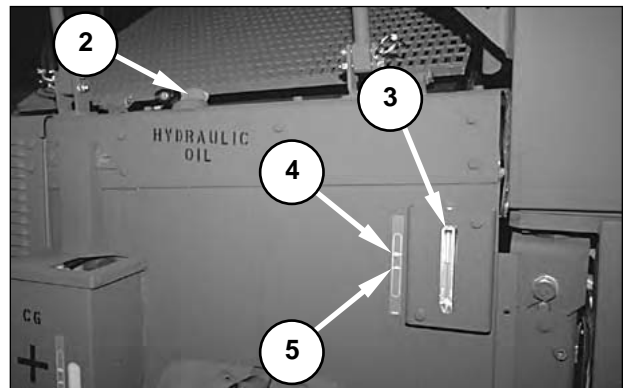

1. Maintain the oil level in sight gauge (3) between top (4) and bottom (5) marks on the decal to the rear of the sight gauge when the machine is on level ground.

NOTE: Use the marks on the decal to determine the correct oil level in the tank. Do not use the marks on the sight glass.

2. Remove oil fill cap (2) and add oil through the fill tube, if necessary.
3. Clean and reinstall oil fill cap (2).

Power Train Oil

Check Oil Level

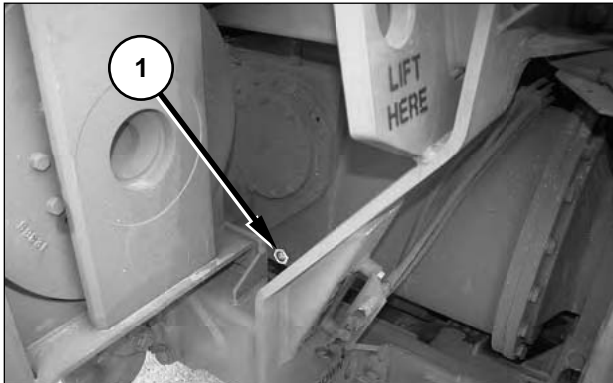

1. Maintain the oil level so that oil is visible in sight gauge (1).

NOTE: Park the machine on flat ground, and check the oil level with the engine not running.

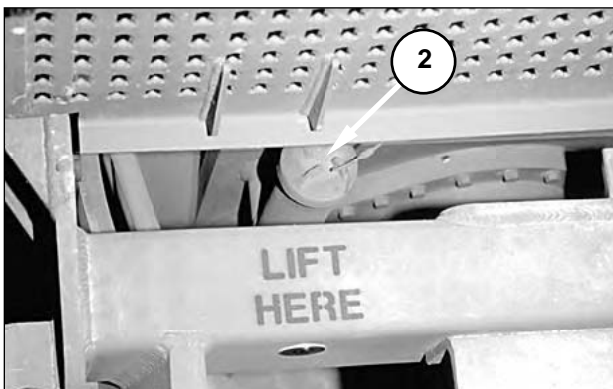

2. Lift the access cover, and remove fill cap (2) and add oil, if necessary.
3. Clean and reinstall the fill cap.

Radiator

Check Coolant Level

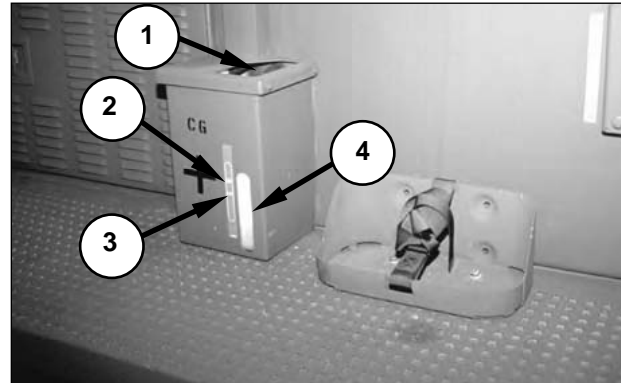

NOTE: Check the coolant level when the engine is at normal operating temperature. Use the engine coolant temperature gauge on the instrument panel to determine the engine's current temperature.

1. Maintain the coolant level in sight gauge (4) between top (2) and bottom (3) marks on the decal, to the rear of the sight gauge.
2. If necessary, remove cap (1) and add the appropriate mixture of coolant and water for the current operating environment.
3. Clean and replace cap (1).

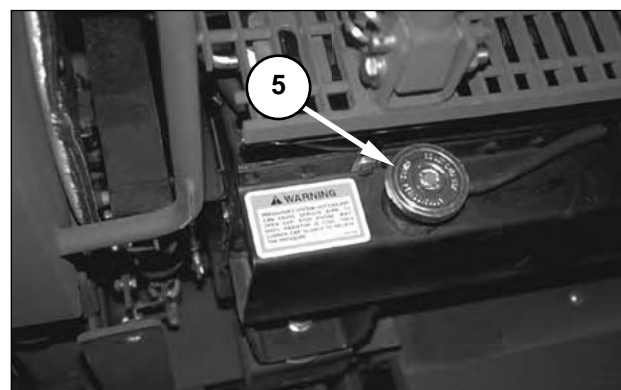

NOTE: If the coolant reservoir is completely empty, allow the engine to cool to ambient temperature. After the engine is cool, fill the radiator directly through radiator cap (5). Operate the machine until the engine has reached normal operating temperature. Add additional coolant to the coolant bottle through cap (1).

Water Separator

Drain Water and Sediment

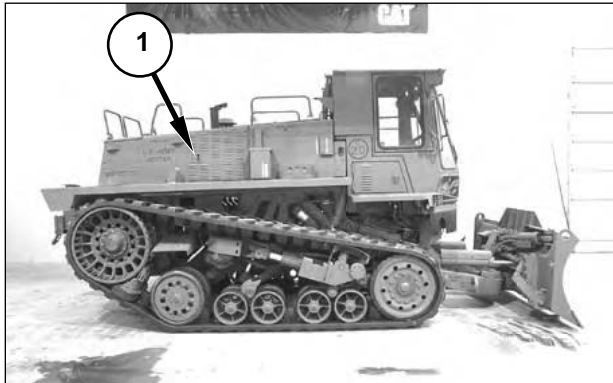

NOTE: The water separator is located in oil filter compartment (1), on the right side of the machine.

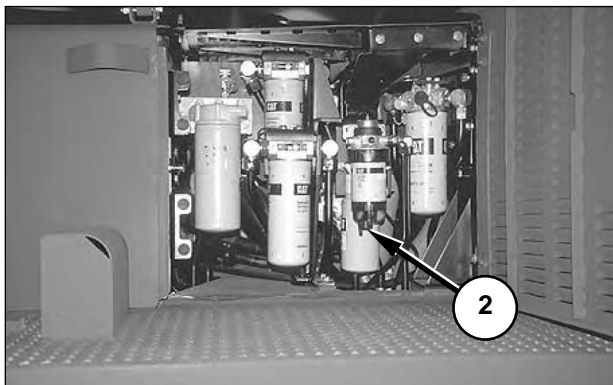

1. Open the oil filter compartment access door.
2. Open drain valve (2) and allow the fuel and water mixture to drain into a suitable container. When no more water is present in the drain stream, close the drain valve.

NOTE: Discard the fluid in accordance with local regulations. Ensure that no fuel from the drain valve drips onto the ground.

3. Close the drain valve.
4. Close the oil filter compartment access door.

Indicators, Gauges, Horn and Lights

Check Operation

Look for broken gauge lenses, indicator lights, switches, etc.

1. Start the engine. Refer to “Before Starting Engine” and “Engine Starting” in this manual.

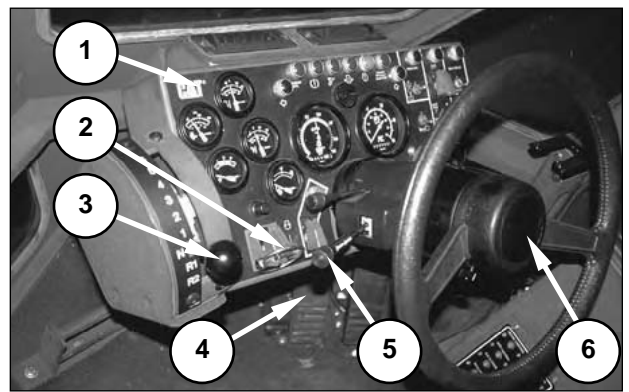

2. Check for inoperative gauges on instrument panel (1).

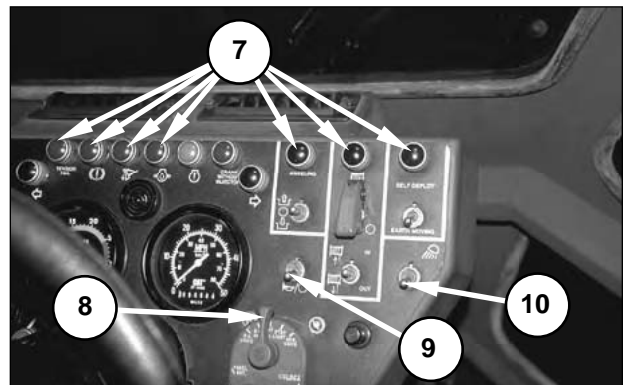

3. Move blackout light switch (8) into the SERVICE DRIVE or STOP LIGHT position, and move horn enable switch (9) to ON.

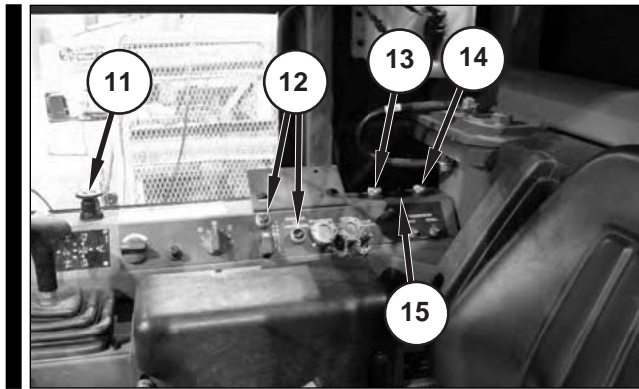

4. With the engine running, hold engine start switch (2) in the START position to check the operation of the indicators (7) on instrument panel (1), and indicators (11) and (12) on the right console. Make note of any inoperative indicators. Release the start switch when the test is complete.
5. Have an assistant activate the recoil alert switch on each side of the machine to verify that lights (13) and (14), and the alarm (15) function properly.
6. Using blackout switch (8), turn signal switch (5), work lights switch (10), and service brake (4), check all machine lights for correct operation. Refer to "Monitoring Systems and Cab Features, Switches" in this manual for information about indicator operation.
7. Press button (6) to sound the forward horn.
8. Report any problems found to Unit Maintenance for repair.

Brakes

Check Operation

1. Start the engine. Refer to "Operation Section, Before Starting Engine" and "Engine Starting" in this manual.

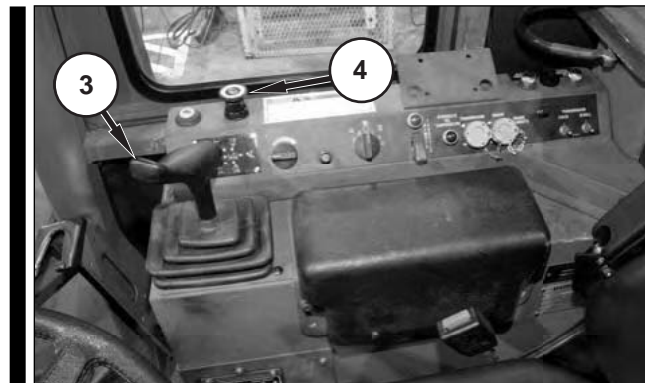
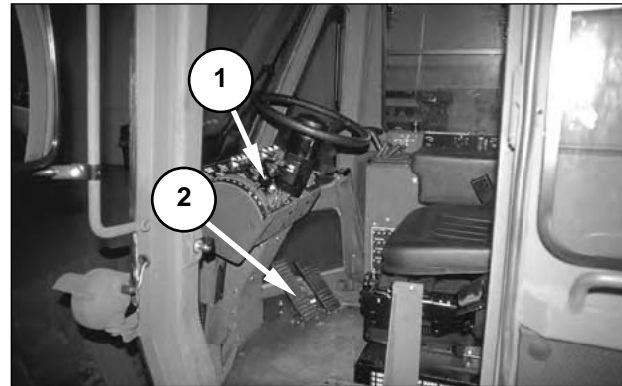

2. Press and hold service brake pedal (2), then push down on knob (4) to release the parking brake.
3. With the service brake still engaged, move transmission control lever (1) to FIRST FORWARD.
4. Release service brake pedal (2), and move the machine FORWARD very slowly. Refer to "Machine Operation" and "Machine Parking" in this manual.
5. Press service brake pedal (2) to stop the machine. If the service brake does not stop the machine, pull knob (4) up to engage the parking brake to stop the machine. If the parking brake does not stop the machine, immediately push blade control lever (3) forward to drop the blade, and move transmission control lever (1) to NEUTRAL.
6. Place the machine in NEUTRAL and engage the parking brake.

7. Report service brake malfunctions to Unit Maintenance for immediate repair.

Backup Alarm

Check Operation

1. Start the engine. Refer to "Operation Section, Before Starting Engine" and "Engine Starting" in this manual.

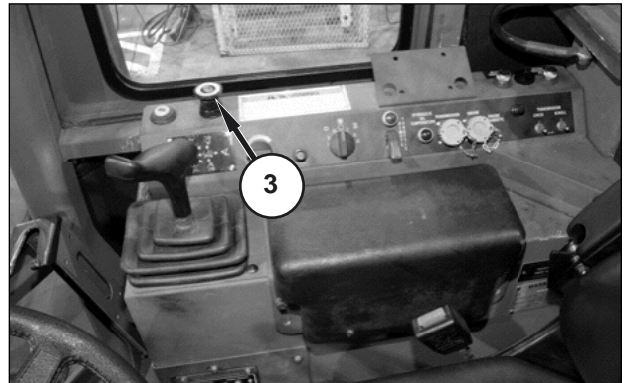
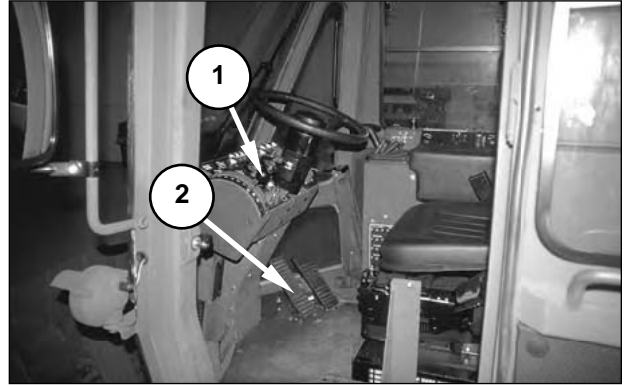

2. Place the blackout light switch into STOP LIGHT and the horn enable switch into ON.
3. Press and hold service brake pedal (2), then push down on knob (3) to release the parking brake.
4. With the service brake still engaged, move transmission control lever (1) to FIRST REVERSE.
5. The backup alarm should sound while the transmission control lever is in FIRST REVERSE.
6. Report backup alarm malfunctions to Unit Maintenance for immediate repair.

Undercarriage

Lubricate

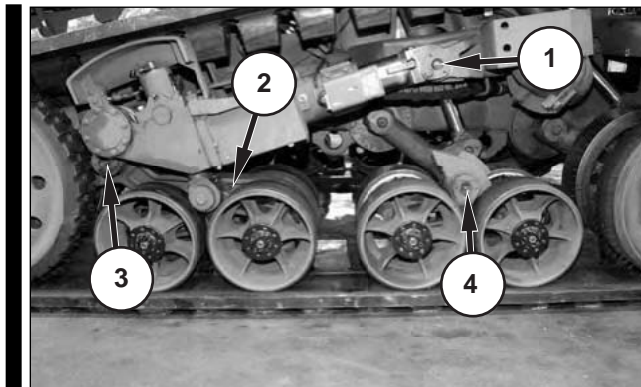

Lubricate four undercarriage fittings on each side of the machine. The four fittings are: (1) tension cylinder pin, (2) front minor bogie pin, (3) major bogie pin, (4) rear minor bogie pin.

NOTE: There are eight undercarriage fittings to be lubricated at this service interval.

Check Oil Level

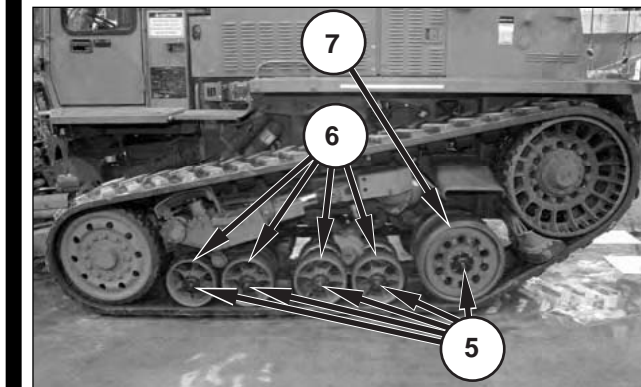

Check oil level in sight gages (5), on outside midrollers (6) and rear idlers (7).

Check Balance

1. Start the engine. Refer to "Operation Section, Before Starting Engine" and "Operation Section, Engine Starting" in this manual.
2. Ensure that the suspension manual lockout valves are open. Refer to "Operation Section, Machine Features, Suspension Manual Lockout Valves" in this manual.
3. Put the machine into SELF-DEPLOY mode. Refer to "Operation Section, Machine Operation, Self-deploy Mode" in this manual.
4. Move the machine to a flat surface, and engage the parking brake. Refer to "Operation Section, Machine Operation, Moving the Machine" and "Operation Section, Machine Parking" in this manual.



5. Check that the left and right side of the machine are approximately the same distance off the ground. Inform Unit Maintenance that the suspension must be recharged if the machine is visibly tilted to the left or right.

NOTE: If the fenders are bent, another point of reference should be used.

NOTE: If necessary, an emergency suspension charging can be performed in the field. For the emergency charging procedure, refer to "Operation Section, Machine Operation, Emergency Suspension Charging" in this manual.

Every 50 Service Hours or Weekly

You must first read and understand the warnings and instructions contained in this manual before performing any operation or maintenance procedures.

Undercarriage

Lubricate

If operating in temperatures above 38°C (100°F), or in very wet conditions (such as fording), lubricate the fittings at this service interval every 10 service hours or daily.

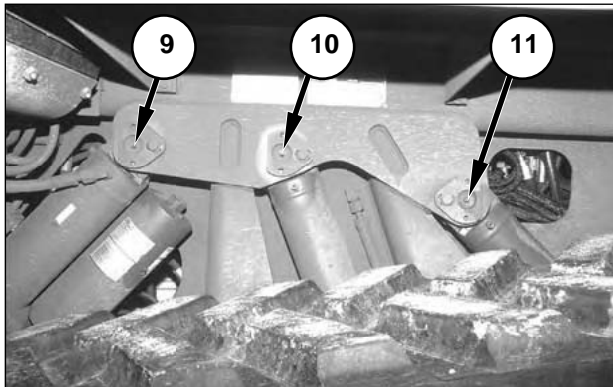
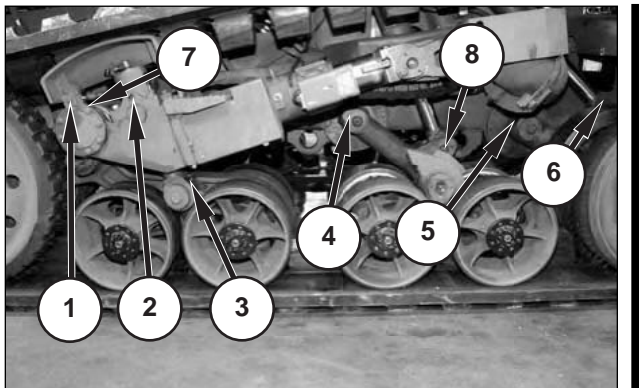

Lubricate 14 undercarriage fittings on each side of the machine. The 14 fittings are: pivot arm (1), bogie cylinder-upper (outer [2] and inner [7]), bogie cylinder-lower (3), middle swing arm (4), rear swing arm (5), rear suspension cylinder-lower (6), middle suspension cylinder-lower (8), front suspension cylinder-upper (9), middle suspension cylinder-upper (10), rear suspension cylinder-upper (11), front suspension cylinder-lower (12), offset arm (13), and front swing arm (14).

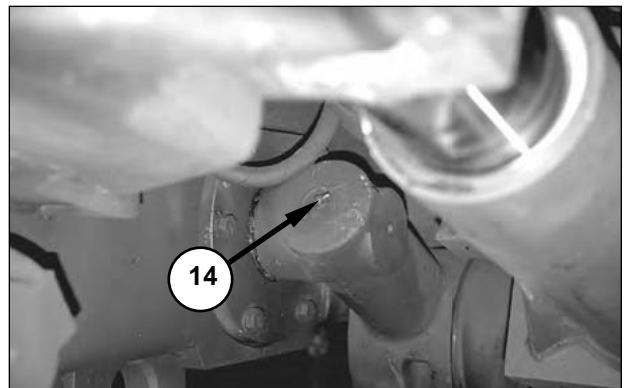
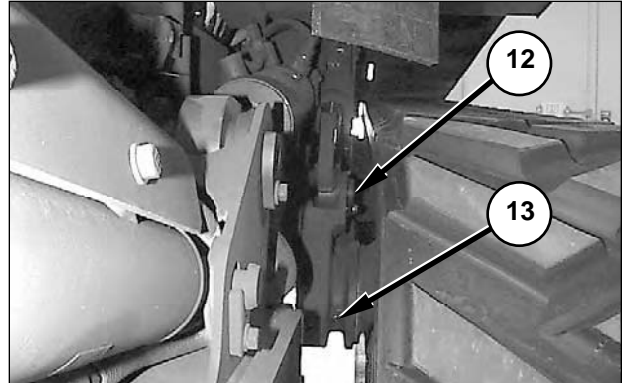

NOTE: There are 28 undercarriage fittings to be lubricated at this service interval.

Check Oil Level

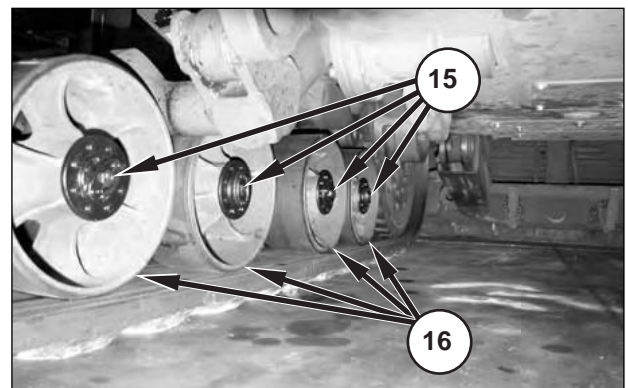

Check oil level in sight gauges (15), on the inside of midrollers (16).

Pintle Hook

Lubricate

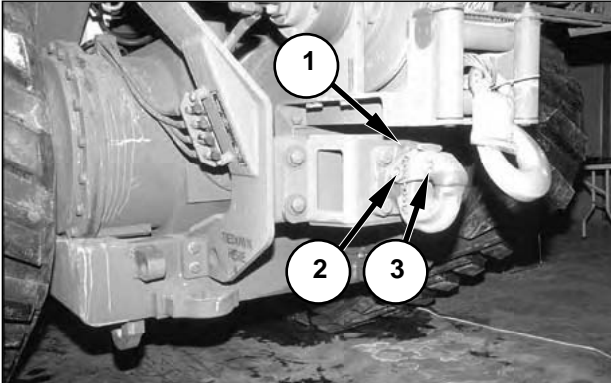

Lubricate a total of three fittings on the pintle hook.

Blade

Lubricate

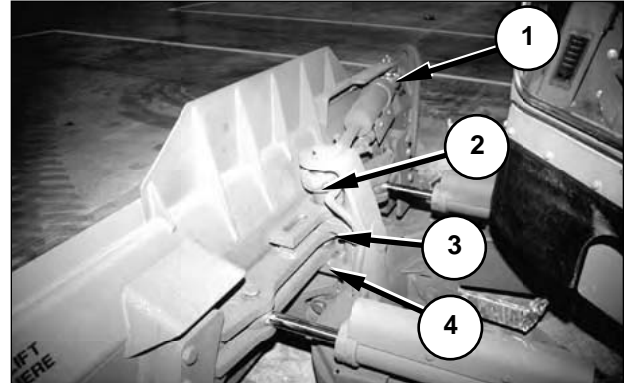

Lubricate four fittings in the tower area of the blade. The four fittings are: (1) angle cylinder-rod end, (2) angle cylinder-head end, (3) singletree-upper, (4) singletree-lower.

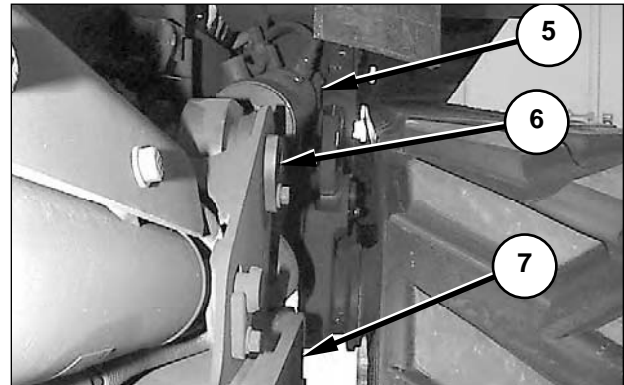

On each side of the machine, lubricate three fittings. The three fittings are: (5) lift cylinder-top, (6) lift cylinder-bottom, (7) C-frame.

NOTE: The blade has a total of ten fittings.

Every 250 Service Hours or 3 Months

You must first read and understand the warnings and instructions contained in this manual before performing any operation or maintenance procedures.

Undercarriage

Cab Pins

Lubricate

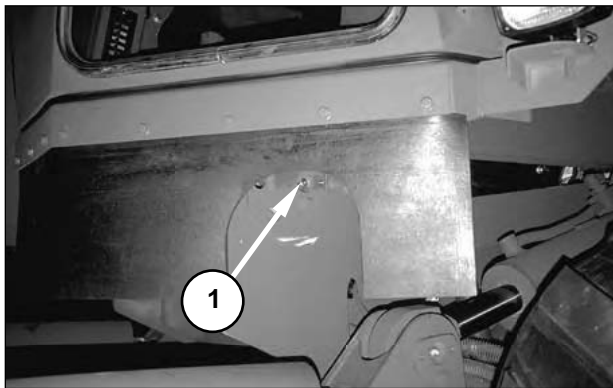

Lubricate cab tilt pin fitting (1) on each side of the machine.

NOTE: There are two cab tilt pin fittings.

Winch

Lubricate

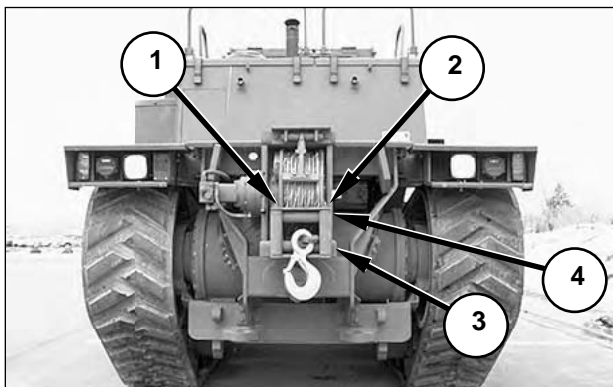

Lubricate four fittings on the fairlead rollers of the winch.

Check Hooks

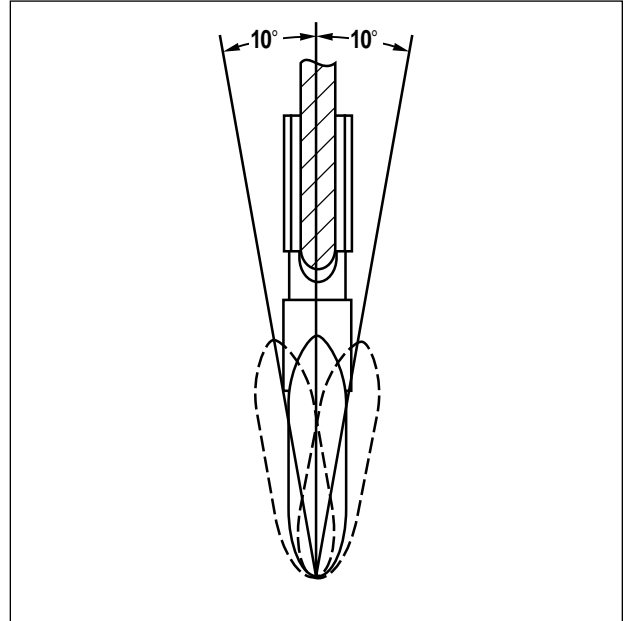

Check the cable and doubling block hooks. Inform Unit Maintenance that the hook must be replaced if it is bent beyond the angle shown above.

Check Cable



Unwind the cable, and check it for kinks and frays. Have Unit Maintenance replace the cable if it is kinked, worn or frayed.

NOTE: For more information, refer to *FM-5-125, Rigging, Techniques, Procedures, and Applications*.

Doubling Block

Lubricate

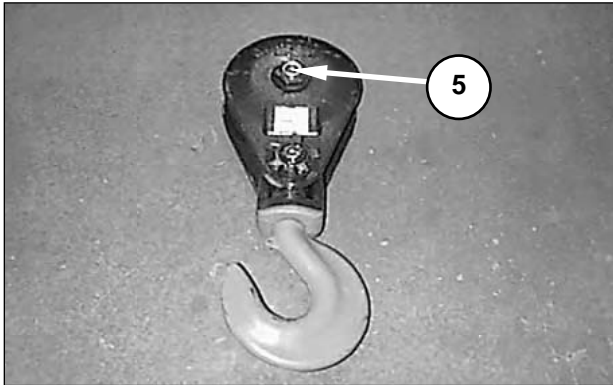

Lubricate the doubling block. There is one fitting.

NOTE: The doubling block is normally stored in the BII box.

Castor Wheel Assembly

Lubricate

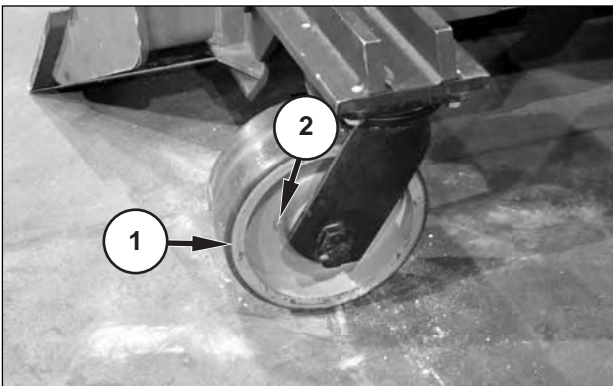

Lubricate castor wheel assemblies (1). There are two fittings (2), one on each side of the wheel.

NOTE: There are two castor wheel assemblies. They are normally stored in the BII box.

Engine Coolant Heater

Check Operation

NOTE: The engine coolant heater is an option that is installed with the arctic starting system. This procedure does not need to be performed if the engine coolant heater is not installed.



Operate the optional engine coolant heater to keep the unit functioning correctly. This procedure should be performed before the engine is started in the morning, while the engine coolant is still at ambient temperature.

NOTE: Do not start the engine.

1. Press engine coolant heater switch (1) to turn the system on. The lamp inside the coolant heater switch will turn on when the system is operating.
2. Allow the engine coolant heater to operate for 10 or 15 minutes, and then press engine coolant heater switch (1) again to turn the coolant heater off.
3. Wait until the lamp inside the coolant heater switch turns off (at least three minutes) before starting the engine.

NOTICE

Do not start the engine while the light in the engine coolant heater switch is on. The engine coolant heater requires three minutes to purge itself of diesel fumes. Damage to the engine coolant heater may result if the engine is started too soon after use.

Index

A

Additives.....	99
After Starting Engine.....	60
Air Conditioning	32
Air Conditioning/Heating Controls.....	32
Air Transport (C-130, C-141, C-5), Preparation for	82
Alternate Exit	32
Arm Rest	30
Auxiliary Start Receptacle (NATO Slave).....	41

B

Back Rippers.....	50 ,66
Back Rippers, Inspect	114
Backup Alarm.....	123
Before Starting the Engine	52
Belt Guide, Inspect	113
Bll Compartment	49
Blackout Light Switch.....	21
Blade, Lubricate	126
Blade Controls.....	50
Blade Down Indicator	26
Brake Release Valve, Emergency.....	49
Brake Switch, Parking	38
Brake, Parking.....	38
Brakes, Check Operation.....	122
Brakes, Service	38

C

Cab Air System, Service Filter Elements	108
Cab Door	31
Cab Pins, Lubricate	127
Cab/Radiator Tilt Controls	45
California, Proposition 65 Warning	3
Cap, Engine Coolant Fill	47
Cap, Fuel Tank Fill	48
Cap, Hydraulic Oil Tank Fill	48
Cap, Power Train Oil Fill	48
Castor Wheel Assembly, Lubricate	128
Caterpillar Transmission/Drive Train Oil (TDTO) (TO-4)	102
Check Engine Indicator.....	26
Circuit Breakers.....	33
Circuit Breakers, Main	41
Circuit Breakers, Reset.....	110
Coat Hook.....	37
Coolant Information, General	99
Coolant Recommendations	100
Coolant Reservoir, Inspect.....	115
Coolant Temperature Gauge.....	24
Cooling Fan	29
Cooling System Specifications.....	99
Crank-Without-Inject Indicator	26

Cutting Edge, Inspect	114
Cylinders, Accumulators and Hoses, Inspect	113

D

Decontamination Container Bracket.....	46
Diagnostic Codes, Engine.....	86
Diesel Engine Oils	102
Disconnect Switch, Main	40
Door, Cab	31
Doubling Block	
Installation	63
Lubricate.....	128
Dozer Blade.....	114
Drive Belt Tension, Emergency	66
Drive Belts, Inspect.....	112
Drive Off	84
Drive Wheels And Scraper Bars, Inspect	113
Drive-on.....	82

E

Earthmoving Mode	61
Electrical Panel and Bll Compartment and Tool/Battery Compartment.....	49
Emergency Brake Release Valve.....	49
Emergency Drive Belt Tension Adjustment Controls	45
Emergency Machine Leveling.....	69
Emergency Suspension Charging and Emergency Drive Belt Tension Procedure	66
Engine Air Intake System	106
Cleaning Primary Element.....	107
Filter Elements, Service.....	106
Inspect Secondary Element.....	107
Primary Element, Cleaning.....	107
Secondary Element, Inspect.....	107
Service Filter Elements	106
Service Primary Element.....	106
Engine Controller Diagnostic Port	19
Engine Coolant Fill Cap	47
Engine Coolant Heater.....	128
Engine Coolant Heater Switch	18
Engine Coolant Temperature Gauge.....	24
Engine Crankcase, Check Oil Level	118
Engine Diagnostic Codes.....	86
Engine Diagnostic Switch	19
Engine Lubricant Specifications	102
Engine Oil Pressure Gauge	24
Engine Oil Pressure Indicator.....	26
Engine Oils, Diesel	102
Engine RPM Gauge	24
Engine Start Switch	17
Engine Starting	54
Engine Starting Above 0°C (32°F).....	54
Engine Starting Below -32°C (-25°F).....	57
Engine Starting Between 0°C and -32°C (32°F and -25°F)	56

Engine Starting with Auxiliary Start (NATO Slave)
 Receptacle.....58
Engine Stopping.....77
Equipment Controls.....50
Every 10 Service Hours or Daily.....112
Every 250 Service Hours or 3 Months.....127
Every 50 Service Hours or Weekly.....125
Exit, Alternate.....32
External Filter.....108

F

Fan, Cooling.....29
Fire Extinguisher Bracket.....46
Fluid Bottle, Windshield Washer.....36
Foreword.....3
Fuel Level Gauge.....25
Fuel Recommendations.....101
Fuel Specifications.....101
Fuel Tank Fill Cap.....48

G

Gauges.....24
Gauges, Inspect.....117
General Coolant Information.....94
General Information, Transportation.....79
Glycol.....99
Grab Rails.....47
Grease, Lubricating.....102
Ground Transportation.....79
Guard, Rear Windshield.....37

H

Hazard Warning Lights.....29
Heating.....32
Horn.....28
Horn Enable Switch.....20
Hydraulic Cylinders, Inspect.....114
Hydraulic Oil Tank Fill Cap.....48
Hydraulic Oil Temperature Indicator.....28
Hydraulic Tank, Check Oil Level.....119

I

Important Safety Information.....4
Indicator Check Function.....27
Indicators.....25
Indicators, Gauges, Horn and Lights, Check
 Operation.....121
Interior Light.....30
Internal Filter, Cab.....109

K

Kneeling Indicator.....26
Kneeling Lock Pin.....44
Kneeling Switch.....42

L

Leaving the Machine.....77
Lifting.....81
Literature Information.....3
Lockout Valves, Suspension Manual.....46
Low Brake Pressure Indicator.....25
Lubricant Specifications.....102
Lubricant Viscosities.....103
Lubricant Viscosities and Refill Capacities.....103
Lubricating Grease.....102
Lubrication Chart.....104

M

Machine Description.....3
Machine Features.....38
Machine Leveling, Emergency.....69
Machine Lifting and Tie Downs.....81
Machine Operation.....61
Machine Parking.....76
Machine Pre-Start Checks.....52
Machine Ridding.....81
Machine Shipping.....79
Machine Stopping.....76
Main Circuit Breakers.....41
Main Disconnect Switch.....40
Maintenance.....3
Maintenance Intervals.....105
Manual Suspension Locking.....61
Midrollers and Idlers, Inspect.....112
Mirrors.....35
Mirrors, Inspect.....117
Monitoring Systems and Cab Features.....17
Moving the Machine.....71

O

Operation.....3
Operating Techniques.....73
 Bulldozing.....73
 Ridding Information.....75
 Back Ripping.....75
Operational Troubleshooting.....88

P

Parking Brake.....38
 Parking Brake Switch113
 Pin Retention Bolts, Inspect.....110
 Pin, Kneeling Lock.....44
 Pintle Hook.....46, 72
 Lubricate.....126
 PLGR Bracket35
 PLGR/SINCGARS Power Strip36
 Power Strip, PLGR/SINCGARS36
 Power Train Oil, Check Oil Level.....120
 Power Train Oil Fill Cap48
 Preparation for Air Transport (C-130, C-141, C-5)...82
 Preparation for Special Shipping Width.....84
 Preparation for Use of Remote Hydraulic Tools.....64
 Problem List88
 Product Identification and Serial Number
 Locations15
 Proposition 65 Warning3

R

Radiator.....110, 120
 Check Coolant Level120
 Clean110
 Rear View Mirror.....35
 Rear Windshield Guard.....37
 Recoil Alert27, 98 ■
 Refill Capacities, Lubricant Viscosities and.....103
 Remote Hydraulic Power Manifold64
 Remote Hydraulic Tool Ports44
 Remote Throttle Indicator27
 Remote Throttle Switch42
 Returning Machine to Normal Operation65
 Rifle Bracket36
 Rippers, Back.....50 ,66
 Rooding, Machine.....81

S

Safety.....3 ,4
 Safety, Alternate Exit.....11
 Safety, Batteries10
 Safety, Before Operating the Machine12
 Safety, Before Starting the Engine11
 Safety, Burn Prevention10
 Safety, Coolant.....10
 Safety, Crushing or Cutting Prevention9
 Safety, Engine Starting12
 Safety, Ether.....11
 Safety, Fire Extinguisher.....10
 Safety, Fire or Explosion Prevention.....10
 Safety, Fluid Penetration9
 Safety, General Hazard Information8
 Safety, Lines, Tubes and Hoses11

Safety, Machine Operation.....12
 Safety, Machine Parking13
 Safety, Mounting and Dismounting11
 Safety, Oils10
 Safety, Performance of Maintenance9
 Safety, Pressure Air9
 Safety, Rollover Protective Structure (ROPS) or
 Falling Objects Protective Structure (FOPS)9
 Seat Adjustment35
 Seat and Seat Belt Checks.....52
 Seat Belt34
 Inspect for Wear or Damage.....118
 Self-Deploy Mode62
 Self-Deploy Mode Indicator.....26
 Self-Deploy/Earthmoving Mode Switch43
 Service Brakes38
 Shipping Width, Preparation for Special.....84
 Side Window32
 SINCGARS Bracket Installation.....36
 Specifications and Model Views.....14
 Speedometer.....24
 Start Receptacle, Auxiliary41
 Start-Aid Indicator26
 Start-Aid Switch18
 Steering Column.....28
 Extend/Retract29
 Tilt.....28
 Steering Wheel39
 Suspension Charging and Drive Belt Tension,
 Emergency.....66
 Suspension Locking, Manual61
 Suspension Manual Lockout Valves.....46
 Swing Arms, Inspect.....112
 Switch, Kneeling.....43
 Switch, Self-Deploy/Earthmoving Mode.....43
 Switch, Winch Control.....43
 Switch, Winch Enable.....43

T

Table of Contents1
 Tension Fail Indicator.....25
 Throttle Switch, Remote42
 Tie Downs82
 Tool Ports, Remote Hydraulic44
 Tool/Battery Compartment49
 Towing Information85
 Transmission Control Lever39
 Transmission Controller Diagnostic Port.....19
 Transmission Diagnostic Check Switch.....19
 Transmission Diagnostic Scroll Switch.....19
 Transmission Oil Temperature Gauge24
 Transportation Information79
 Transportation, Ground.....79
 Troubleshooting.....86
 Turn Signal28

Turn Signal Indicator.....26

U

Undercarriage.....123, 125
 Check Balance.....124
 Lubricate.....123
 Lubricate.....125

V

Ventilation Louvers.....33
Voltmeter.....24

W

Walk-Around Inspection.....112
 Air Filter Compartment116
 Cab.....116
 Dozer Blade114
 Hydraulic Oil Tank116
 Oil Filter Compartment116
 Power Train.....115
 Radiator115
 Seat Belt118
 Undercarriage.....112
 Winch.....115
Warning Labels.....5
Washer/Wiper Control28
Water99
Water Separator, Drain Water and Sediment121
When Required.....106
Winch.....127
 Check Cable127
 Check Hooks127
 Inspect.....115
 Lubricate.....127
Winch Clutch.....51
Winch Control Switch43
Winch Control Switches.....43
Winch Controls.....51
Winch Enable Switch43
Winch Indicator.....26
Winch Operation.....63
Window, Side32
Windows and Wiper Blades, Inspect116
Windshield Washer Fluid, Refill Container111
Windshield Washer Fluid Bottle.....36
Windshield Washer Fluid Bottle, Inspect117
Windshield Wipers, Replace Blade.....111
Work Light Switch20

APPENDIX A
Operator Preventive Maintenance Checks and Services (PMCS)

GENERAL

- a. Do your “before” PMCS just before you operate the tractor. Pay attention to CAUTIONS and WARNINGS.
- b. Do your “during” PMCS while you are operating the tractor. Pay attention to CAUTIONS and WARNINGS.
- c. Do your “after” PMCS right after operating the tractor. Pay attention to CAUTIONS and WARNINGS.
- d. Do your “weekly” PMCS every 7 days.
- e. Do your “quarterly” PMCS every 90 days.
- f. If something does not work, troubleshoot it with the instructions in this manual. Report any deficiencies using the proper forms. See DA PAM 738-750.
- g. Always do your PMCS in the same order so they become a habit. Once you have had some practice, you’ll spot anything wrong in a hurry.
- h. If anything looks wrong and you can’t fix it, write it on your DA Form 2404. If something is seriously wrong, report it to Unit Maintenance RIGHT NOW.
- i. When you do your PMCS, take the proper tools needed to make all checks. Always use clean rags.

PMCS PROCEDURES

- a. Doing PMCS will help avoid unnecessary equipment breakdowns.
- b. The following items are a description of the columns in the PMCS table.
 - (1) Item Number. These numbers indicate the order in which the PMCS should be performed. They are to be used when recording the results of PMCS for the TM number column on DA Form 2404, Equipment Inspection and Maintenance Worksheet.
 - (2) Interval. The interval tells when the PMCS should be performed. See the key at the top of the table to determine what each column represents.
 - (3) Item To Be Inspected/Procedure. This column tells you the specific item to be checked or serviced and how to do the check or service.

- (4) Equipment Is Not Fully Mission Capable If. This column lists equipment conditions that mean the tractor or its implement cannot be safely used. DO NOT use the tractor until the condition has been remedied.
- c. Leakage definitions for Operator/Crew PMCS are as follows:
- (1) Class I—Seepage of fluid (as indicated by wetness or discoloration) not great enough to form drops.
 - (2) Class II—Leakage of fluid great enough to form drops, but not enough to cause drops to drip from the item being inspected.
 - (3) Class III—Leakage of fluid great enough to form drops that fall from the item being inspected.
- d. If possible, park the machine on level ground when finishing operation. This will allow you to get accurate fluid level readings when performing the PMCS before resuming operation.

PREVENTIVE MAINTENANCE CHECKS AND SERVICES—DEUCE

Item No.	Interval	Item To Be Inspected	Equipment Status
		<div style="background-color: black; color: white; padding: 5px; text-align: center;">  WARNING </div> <p>You must first read and understand the warnings and instructions contained in this manual before performing any operation or maintenance procedures. Failure to follow the instructions or heed the warnings may result in injury or death.</p> <hr/> <p>NOTE: Perform all weekly and before operation PMCS if:</p> <ul style="list-style-type: none"> (1) You are the assigned operator and have not operated since the last weekly PMCS. (2) You are operating the machine for the first time. <p>See TM11-5825-291-13 for PLGR PMCS</p> <p>See TM11-5820-890-10 for SINCGARS PMCS</p>	
1	Before	<p style="text-align: center;">UNDERCARRIAGE</p> <p>NOTE: For illustrations of these steps, refer to “Maintenance Section, Every 10 Service Hours or Daily, Undercarriage” in this manual.</p> <ul style="list-style-type: none"> (1) Clean away any dirt and debris on the idlers, rollers, accumulators and cylinders. 	

PREVENTIVE MAINTENANCE CHECKS AND SERVICES – DEUCE

Item No.	Interval	Item To Be Inspected	Equipment Status
	Before	(3) Check the midrollers and the front and rear idlers for oil leaks.	<ul style="list-style-type: none"> • The equipment is not ready/available if class III leaks are present.
	Before	(4) Check the oil level in the sight gauge on the outside of the midrollers and the rear idlers.	<ul style="list-style-type: none"> • The equipment is not ready/available if no oil is visible in the sight gauge or oil is not at the required level.
	Before	(5) Inspect the midrollers for wear and damage.	<ul style="list-style-type: none"> • The equipment is not ready/available if more than 50% of the rubber is missing from any of the midrollers.
	Before	(6) Inspect the front and rear idlers for damage and loose bolts.	<ul style="list-style-type: none"> • The equipment is not ready/available if more than 25% of the rubber is missing on any component or there are any loose idler bolts.

PREVENTIVE MAINTENANCE CHECKS AND SERVICES—DEUCE

Item No.	Interval	Item To Be Inspected	Equipment Status
	Before	(7) Check the swing arm pivot joints for loose or missing bolts.	<ul style="list-style-type: none"> • The equipment is not ready/available if there are any loose or missing bolts.
	Before	(8) Check the suspension cylinders, accumulators and hoses for leaks.	<ul style="list-style-type: none"> • The equipment is not ready/available if class III leaks are present.
	Before	(9) Check the drive wheels for leaks, missing drive slats, and/or loose bolts.	<ul style="list-style-type: none"> • The equipment is not ready/available if class III leaks are present around the hub, more than two drive slats in a row are missing, more than four drive slats in a group of ten are missing, more than a total of six drive slats on a drive wheel are missing, or there are any loose or missing bolts.
	Before	(10) Check the scraper bars for damage and loose or missing bolts.	<ul style="list-style-type: none"> • The equipment is not ready/available if there are any loose or missing bolts, the scraper bars are bent, or the rubber flaps are missing.

PREVENTIVE MAINTENANCE CHECKS AND SERVICES—DEUCE

Item No.	Interval	Item To Be Inspected	Equipment Status
	Before	(11) Check all undercarriage pins for loose or missing retaining bolts.	<ul style="list-style-type: none"> • The equipment is not ready/available if there are any loose or missing pin retaining bolts.
	Before	(12) Check the belt guides for wear and loose or missing bolts.	<ul style="list-style-type: none"> • The equipment is not ready/available if a hole has worn in belt guide, or if there are loose or missing bolts.
	Before	(13) Lubricate the undercarriage pins. There are a total of eight fittings.	<ul style="list-style-type: none"> • The equipment is not ready/available if grease does not flow out of the pin seals when grease is added to the joint.
	Before	(14) Check suspension manual lockout valves if the machine will be operated in the SELF-DEPLOY mode. Move the valves to the OPEN position. Refer to “Operation Section, Machine Features, Suspension Manual Lockout Valves” in this manual.	
	Before	(15) Check balance. Check that the left and right side of the machine are approximately the same distance off the ground. Refer to “Maintenance Section, Every 10 Service Hours or Daily, Undercarriage” in this manual.	<ul style="list-style-type: none"> • The equipment is not ready/available if the machine appears to be out of balance an estimated 102 mm (4 in) or more.

PREVENTIVE MAINTENANCE CHECKS AND SERVICES—DEUCE

Item No.	Interval	Item To Be Inspected	Equipment Status
2		<p style="text-align: center;">DOZER BLADE</p> <p>NOTE: For illustrations of these steps, refer to “Every 10 Service Hours or Daily, Dozer Blade” in this manual.</p> <p>(1) Check the cutting edges and end bits for damage or loose or missing hardware.</p> <p>(2) Check the angle, lift, and tilt cylinders, and attached hoses for leakage.</p> <p>(3) Check the back ripper teeth and shanks for wear and damage.</p>	<ul style="list-style-type: none"> • The equipment is not ready/available if the cutting edges, bolts, or end bits are missing, or if the cutting edges or end bits are worn within 19 mm (0.75 in) of the base edge of the blade. • The equipment is not ready/available if class III leaks are present. • The equipment is not ready/available if a tooth is worn through, exposing a retainer, or if any tooth or shank is missing or damaged, when the mission requires use of the ripper.

PREVENTIVE MAINTENANCE CHECKS AND SERVICES—DEUCE

Item No.	Interval	Item To Be Inspected	Equipment Status
	Before	(4) Check blade for cracks, bending, or loose or missing fasteners.	<ul style="list-style-type: none"> • The equipment is not ready/available if any components are cracked or bent, or any fasteners are loose or missing.
3		<p style="text-align: center;">WINCH</p> <p>NOTE: For illustrations of these steps, refer to “Maintenance Section, Every 10 Service Hours or Daily, Winch” in this manual.</p> <p>Before (1) Check the winch motor and attached hoses for leaks. Also, check any other visible hoses at the rear of the machine for leaks</p> <p>Before (2) Check the winch frame for cracks, bending, or loose or missing fasteners.</p> <p>Before (3) Check for cracked or bent fairlead rollers.</p>	<ul style="list-style-type: none"> • The equipment is not ready/available if class III leaks are present. • The equipment is not ready/available if there are any cracks, bent components, or loose or missing fasteners, and mission requires the use of winch. • The equipment is not ready/available if any roller is bent or cracked, and mission requires the use of winch.

PREVENTIVE MAINTENANCE CHECKS AND SERVICES—DEUCE

Item No.	Interval	Item To Be Inspected	Equipment Status
	Before	(4) Check the winch hook for bending or damage.	<ul style="list-style-type: none"> • The equipment is not ready/available if the winch hook is bent or cracked. and mission requires the use of winch.
4	<p>Before</p> <p>Before</p>	<p>POWER TRAIN (DIFFERENTIAL STEER)</p> <p>NOTE: For illustrations of these steps, refer to “Maintenance Section, Every 10 Service Hours or Daily, Power Train” and “Every 10 Service Hours or Daily, Power Train Oil” in this manual.</p> <p>(1) Check the power train oil level. Oil must be visible in the sight glass.</p> <p>(2) Check the power train housing and steering motor for leaks.</p>	<ul style="list-style-type: none"> • The equipment is not ready/available if oil is not visible in the sight glass. • The equipment is not ready/available if class III leaks are present.
5		<p>RADIATOR</p> <p>NOTE: For illustrations of these steps, refer to “Maintenance Section, Every 10 Service Hours or Daily, Radiator” in this manual.</p>	

PREVENTIVE MAINTENANCE CHECKS AND SERVICES—DEUCE

Item No.	Interval	Item To Be Inspected	Equipment Status
	Before	(1) Check for accumulated debris by raising the radiator guard.	<ul style="list-style-type: none"> • The equipment is not ready/available if the radiator cooling fins are plugged by accumulated debris.
	Before	(2) Check the cooling system for leaks.	<ul style="list-style-type: none"> • The equipment is not ready/available if class III leaks are present.
	Before	(3) Check the coolant level in the coolant reservoir.	<ul style="list-style-type: none"> • The equipment is not ready/available if the coolant is not visible in the reservoir.
6		<p style="text-align: center;">AIR FILTER COMPARTMENT</p> <p>NOTE: For illustrations of these steps, refer to “Maintenance Section, Every 10 Service Hours or Daily, Air Filter Compartment” and “Every 10 Service Hours or Daily, Engine Crankcase” in this manual.</p> <p>(1) Check the engine oil level (engine not running).</p>	<ul style="list-style-type: none"> • The equipment is not ready/available if the oil level is below the ADD mark or above the full mark.

PREVENTIVE MAINTENANCE CHECKS AND SERVICES—DEUCE

Item No.	Interval	Item To Be Inspected	Equipment Status
	<p>Before</p> <p>Before</p>	<div style="background-color: black; color: white; padding: 5px; text-align: center;">  WARNING </div> <p>If nuclear, biological, or chemical (NBC) exposure is suspected, all filter media should be handled by personnel wearing protective equipment. Consult the unit NBC officer or NBC noncommissioned officer for appropriate handling or disposal procedures.</p> <p>(2) Check the air filter service indicator. Refer to “Maintenance Section, When Required, Engine Air Intake System, Service Filter Elements.”</p> <p>(3) Check all visible hoses in the air filter compartment for leaks.</p>	<ul style="list-style-type: none"> • The equipment is not ready/available if red reappears in the window after the indicator has been reset and the engine operated at full speed. • The equipment is not ready/available if class III leaks are present.
7		<p style="text-align: center;">OIL FILTER COMPARTMENT</p> <p>NOTE: For illustrations of these steps, refer to “Maintenance Section, Every 10 Service Hours or Daily, Oil Filter Compartment” and “Every 10 Service Hours or Daily, Water Separator” in this manual.</p>	

PREVENTIVE MAINTENANCE CHECKS AND SERVICES—DEUCE

Item No.	Interval	Item To Be Inspected	Equipment Status
	Before	(1) Check the filters for leaks.	
	Before	(2) Check all visible hoses in the oil filter compartment for leaks.	<ul style="list-style-type: none"> • The equipment is not ready/available if class III leaks are present.
	Before	(3) Check for water in the fuel and water separator. Drain any water or debris in the fuel water separator into a suitable container. Discard the fuel in accordance with local regulations.	<ul style="list-style-type: none"> • The equipment is not ready/available if class III leaks are present.
8		<p style="text-align: center;">HYDRAULIC TANK</p> <p>NOTE: For illustrations of these steps, refer to “Maintenance Section, Every 10 Service Hours or Daily, Hydraulic Oil Tank” and “Every 10 Service Hours or Daily, Hydraulic Tank” in this manual.</p>	
	Before	(1) Check the hydraulic oil level.	<ul style="list-style-type: none"> • The equipment is not ready/available if the hydraulic oil is below ADD on the decal.
	Before	(2) Check the hydraulic tank for leaks.	<ul style="list-style-type: none"> • The equipment is not ready/available if class III leaks are present.

PREVENTIVE MAINTENANCE CHECKS AND SERVICES—DEUCE

Item No.	Interval	Item To Be Inspected	Equipment Status
9		<p style="text-align: center;">CAB</p> <p>NOTE: For illustrations of these steps, refer to “Maintenance Section, Every 10 Service Hours or Daily, Cab” and “Every 10 Service Hours or Daily, Seat Belt” in this manual.</p> <p>Before (1) Check that you can see clearly through all windows. Clean any dirty windows with window cleaner.</p> <p>Before (2) Check the wiper blade.</p> <p>Before (3) Check the inside and outside mirrors.</p>	<p>a. The equipment is not ready/available if the front windshield is cracked and the vehicle is to be used on public roads.</p> <p>b. The equipment is not ready/available if the front main windshield is permanently cloudy or is cracked and obstructs the operator’s vision.</p> <ul style="list-style-type: none"> • The equipment is not ready/available if the blade is missing or damaged and conditions require wiper use. • The equipment is not ready/available if any mirror is broken so that there are pieces of glass missing.

PREVENTIVE MAINTENANCE CHECKS AND SERVICES—DEUCE

Item No.	Interval	Item To Be Inspected	Equipment Status
	Before	(4) Check all gauges for damage.	<ul style="list-style-type: none"> • The equipment is not ready/available if any gauge is not readable.
	Before	(5) Check the date tag on the seat belt. Fully extend the belt to check the tag.	<ul style="list-style-type: none"> • The equipment is not ready/available if the date on belt tag is more than three years old.
	Before	(6) Check the seat belt for wear and damage.	<ul style="list-style-type: none"> • The equipment is not ready/available if the seat belt is worn or frayed.
	Before	(7) Check the seat and seat belt mounting hardware.	<ul style="list-style-type: none"> • The equipment is not ready/available if any seat or seat belt mounting bolt is loose or missing.
	Before	(8) Check the seat adjustments.	<ul style="list-style-type: none"> • The equipment is not ready/available if the seat will not lock in a position for safe operation.
	Before	(9) Check the windshield washer reservoir. Fill the reservoir with windshield washer solvent if the level is low.	

PREVENTIVE MAINTENANCE CHECKS AND SERVICES—DEUCE

Item No.	Interval	Item To Be Inspected	Equipment Status
10		<p style="text-align: center;">INDICATORS, GAUGES, HORN AND LIGHTS</p> <p>NOTE: For illustrations of these steps, refer to “Maintenance Section, Every 10 Service Hours or Daily, Indicators, Gauges, Horn, and Lights” in this manual.</p> <p>a. Indicators</p> <p>Before (1) Check the backup alarm for correct operation. Refer to “Maintenance Section, Every 10 Service Hours or Daily,” “Back-up Alarm.”</p> <p>Before (2) Start the engine. Refer to “Operation Section, Machine Operation, Engine Starting.” Operate the indicator test function. Refer to “Monitoring System and Cab Features, Indicator Check Function.”</p> <p>Before (3) Have an assistant activate the recoil alert switch on each side of the machine. Alarm and light should activate.</p>	<ul style="list-style-type: none"> • The equipment is not ready/available if the backup alarm does not sound. • The equipment is not ready/available if the appropriate indicators fail to illuminate when the start switch is held in the start position. Refer to “Operation Section, Monitoring System and Cab Features, Indicator Check Function.” • The equipment is not ready/available if the light and/or alarm does not activate.

PREVENTIVE MAINTENANCE CHECKS AND SERVICES—DEUCE

Item No.	Interval	Item To Be Inspected	Equipment Status
	Before	<p>b. Horn</p> <p>Test the operation of the machine horn.</p>	<ul style="list-style-type: none"> • The equipment is not ready/available if the horn does not function properly.
	Before	<p>c. Lights</p> <p>Check operation of all machine lights.</p>	<ul style="list-style-type: none"> • The equipment is not ready/available if any light does not illuminate and the light is required for the mission. Refer to “Operation Section, Monitoring Systems and Cab Features, Switches” in this manual.

PREVENTIVE MAINTENANCE CHECKS AND SERVICES—DEUCE

Item No.	Interval	Item To Be Inspected	Equipment Status
11		<p style="text-align: center;">MACHINE CONTROLS</p> <p>NOTE: For illustrations of these steps, refer to “Maintenance Section, Every 10 Service Hours or Daily, Steering and Brakes” in this manual.</p> <p>a. Service Brakes</p> <p>Before Check that depressing the service brake pedal stops the machine while it is moving ahead slowly.</p> <p>b. Steering Controls</p> <p>Before (1) Check that turning the steering wheel causes the machine to turn in the expected direction while it is traveling in FORWARD and REVERSE.</p> <p>Before (2) Check the steering response at moderate speeds.</p>	<ul style="list-style-type: none"> • The equipment is not ready/available if the brakes do not stop the tractor. • The equipment is not ready/available if the machine fails to turn in the expected direction. • The equipment is not ready/available if the steering is sluggish.

PREVENTIVE MAINTENANCE CHECKS AND SERVICES—DEUCE

Item No.	Interval	Item To Be Inspected	Equipment Status
		<p>c. Implement Controls</p> <p>(1) Check that the blade controls will fully raise, lower, angle and tilt the blade. Refer to “Operation Section, Equipment Controls, Blade Controls” in this manual.</p> <p>(2) Check that the winch control switch operates the winch. Have an observer verify that the cable runs in and out. Refer to “Operation Section, Machine Features, Switches” and “Equipment Controls, Winch” in this manual.</p> <p>d. Kneeling Mode</p> <p>Check that the kneeling switch raises and lowers the front of the machine. Refer to “Operation Section, Machine Features, Switches” in this manual.</p>	<ul style="list-style-type: none"> • The equipment is not ready/available if the blade does not function correctly. • The equipment is not ready/available if the winch does not function correctly and mission requires use of winch. • The equipment is not ready/available if the machine fails to lower or raise, and C130/C17 air transportation is required.

PREVENTIVE MAINTENANCE CHECKS AND SERVICES—DEUCE

Item No.	Interval	Item To Be Inspected	Equipment Status
		<p>e. Self-Deploy/Earthmoving Mode</p> <p>(1) Check that the suspension system is active when the machine is in the SELF-DEPLOY mode by having an observer watch the suspension components while the machine is moving slowly over rough terrain (or driving over a solid object). Refer to “Operation Section, Machine Features, Self-Deploy/Earthmoving Mode Switch” and “Machine Features, Suspension Manual Lockout Valves” in this manual.</p> <p>(2) Check that the suspension system is locked when the machine is in the EARTHMOVING mode by having an observer watch the suspension components while the machine is slowly moving FORWARD over rough terrain (or driving over a solid object). Refer to “Operation Section, Machine Features, Self-Deploy/Earthmoving Mode Switch” and “Machine Features, Suspension Manual Lockout Valves” in this manual.</p>	<ul style="list-style-type: none"> • The equipment is not ready/available if the rear suspension cylinder fails to extend and retract as the idlers roll over the rough terrain (or a solid object). • The equipment is not ready/available if the rear suspension cylinder continues to extend and retract as the idlers roll over rough terrain (or a solid object.)

PREVENTIVE MAINTENANCE CHECKS AND SERVICES—DEUCE

Item No.	Interval	Item To Be Inspected	Equipment Status
12	Before	<p style="text-align: center;">EXHAUST</p> <p>Check for excessive black, blue, or white smoke, and unusual noise.</p>	<ul style="list-style-type: none"> • The equipment is not ready/available if the engine produces excessive black, blue, or white smoke; or the engine is making an unusual noise.
13	Before	<p style="text-align: center;">BATTERIES</p> <p>Check batteries for corrosion, loose wires, and low water.</p>	<ul style="list-style-type: none"> • The equipment is not ready/available if the water level is below the plates or if the vehicle will not start.
14	Before	<p style="text-align: center;">COMPONENTS OF END ITEM (COEI)</p> <p>Check that all COEI are on the vehicle and are in working condition. Refer to “Appendix B, Components of End Item (COEI)” in this manual.</p>	<ul style="list-style-type: none"> • The equipment is not ready/available if COEI are missing or broken.
15.	Before	<p style="text-align: center;">BASIC ISSUE ITEMS (BII)</p> <p>Check that all BII are on the vehicle and are in working condition. Refer to “Appendix C, Basic Issue Items (BII) List” in this manual.</p>	<ul style="list-style-type: none"> •The equipment is not ready/available if BII are missing or broken.

PREVENTIVE MAINTENANCE CHECKS AND SERVICES—DEUCE

Item No.	Interval	Item To Be Inspected	Equipment Status
16		INDICATORS, GAUGES, HORN AND LIGHTS	<ul style="list-style-type: none"> • The equipment is not ready/available if the engine oil pressure indicator, tension fail indicator, low brake pressure indicator, or hydraulic oil temperature indicator illuminates. <p>The equipment is not ready/available if the recoil alert sounds. Refer to “Operation Section, Operating Techniques, Bulldozing,” in this manual.</p> <ul style="list-style-type: none"> • The equipment is not ready/available if any gauge is not indicating normal operation. Refer to “Operation Section, Monitoring Systems and Cab Features, Gauges,” in this manual.
	During	Inspect the indicators during normal operation.	
	During	<p>a. Indicators</p> <p>Monitor recoil alert during normal operations.</p>	
During	<p>b. Gauges</p> <p>Inspect all gauges for proper readings.</p>		

PREVENTIVE MAINTENANCE CHECKS AND SERVICES – DEUCE

Item No.	Interval	Item To Be Inspected	Equipment Status
16A		<p style="text-align: center;">FUEL TANK</p> <p>NOTE: Refer to “Operation Section Machine Features, Fuel Tank Fill Cap” in this manual.</p> <p>After (1) Check for missing or damaged fuel cap.</p> <p>After (2) Check the fuel level and the fuel tank for visible leaks. Fill the fuel tank if it is low.</p> <p>After (3) Check the cleanliness of the fuel cap. Clean the fuel cap if it is dirty.</p>	<ul style="list-style-type: none"> • The equipment is not ready/available if the fuel cap is missing or damaged. • The equipment is not ready/available if any leaks are found.
17	Weekly	<p style="text-align: center;">UNDERCARRIAGE</p> <p>NOTE: For illustrations of the lubrication points, refer to “Maintenance Section, Lubrication Chart,” and “Every 50 Service Hours or Weekly, Undercarriage,” in this manual.</p> <p>a. Lubricate</p> <p>Lubricate the undercarriage grease fittings. There are 28 fittings to be lubricated at this interval.</p>	<ul style="list-style-type: none"> • The equipment is not ready/available if grease does not flow out of the pin seals when grease is added to the joint.

PREVENTIVE MAINTENANCE CHECKS AND SERVICES – DEUCE

Item No.	Interval	Item To Be Inspected	Equipment Status
	Weekly	<p>b. Check Oil Level</p> <p>Check oil level in sight gauges on inside midrollers and rear idlers.</p>	<ul style="list-style-type: none"> • The equipment is not ready/available if oil is not visible in the sight gauge, or at the required level.

PREVENTIVE MAINTENANCE CHECKS AND SERVICES—DEUCE

Item No.	Interval	Item To Be Inspected	Equipment Status
18	Weekly	<p style="text-align: center;">BLADE</p> <p>NOTE: For illustrations of the lubrication points, refer to “Maintenance Section, Lubrication Chart” and “Every 50 Service Hours or Weekly, Blade” in this manual.</p> <p>Lubricate the blade grease fittings. There are ten fittings.</p>	<ul style="list-style-type: none"> • The equipment is not ready/available if grease does not flow out of the pin seals when grease is added to the joint.
19	Weekly	<p style="text-align: center;">PINTLE HOOK</p> <p>NOTE: For illustrations of the lubrication points, refer to “Lubrication Chart” and “Maintenance Section, Every 50 Service Hours or Weekly, Pintle Hook” in this manual.</p> <p>Lubricate the pintle hook grease fittings. There are three fittings.</p>	
20	<p>Quarterly</p> <p>Quarterly</p>	<p style="text-align: center;">WINCH</p> <p>NOTE: For illustrations of the lubrication points, refer to “Maintenance Section, Lubrication Chart” and “Every 250 Service Hours or 3 Months, Winch” in this manual.</p> <p>(1) Lubricate fairleads. There are four fittings.</p> <p>(2) Lubricate the doubling block. There is one fitting.</p> <p>NOTE: The doubling block is normally stored in the BII box.</p>	

PREVENTIVE MAINTENANCE CHECKS AND SERVICES – DEUCE

Item No.	Interval	Item To Be Inspected	Equipment Status
	Quarterly	(3) Check cable for fraying, kinking, and signs of damage or rusting.	<ul style="list-style-type: none"> • The equipment is not ready/available if the cable is kinked or frayed. For additional information about checking cables, refer to “FM-5-125, Rigging, Techniques, Procedures, and Applications.” • The equipment is not ready/available if the hook is worn, cracked, or bent beyond 10 degrees.
	Quarterly	(4) Check the doubling block hook for wear and damage.	
21	Quarterly	<p style="text-align: center;">CAB</p> <p>NOTE: For illustrations of the lubrication points, refer to “Maintenance Section, Lubrication Chart” and “Every 250 Service Hours or 3 Months” in this manual.</p> <p>Lubricate the cab pin grease fittings. There are a total of two fittings.</p>	
22	Quarterly	<p style="text-align: center;">ENGINE COOLANT HEATER</p> <p>Operate the engine coolant heater if it is installed on the machine.</p>	<ul style="list-style-type: none"> • The equipment is not ready/available if the engine coolant heater does not operate correctly, and temperatures below -32°C (-25°F) are expected.

PREVENTIVE MAINTENANCE CHECKS AND SERVICES – DEUCE

Item No.	Interval	Item To Be Inspected	Equipment Status
23	Quarterly	<p style="text-align: center;">AIR CONDITIONER UNIT</p> <p>NOTE: Refer to <i>Periodic Maintenance and Special Operation , Deployable Universal Combat Earthmover (DEUCE), Operations Section, Machine Storage, Preparation of Air Conditioner Unit for Seasonal Use.</i></p> <p>(1) Check operation of the air conditioner compressor. Run compressor for a minimum of 30 seconds.</p>	
24	Quarterly	<p style="text-align: center;">CASTOR WHEEL ASSEMBLIES</p> <p>Lubricate fittings located on each castor wheel assembly. Rotate each wheel assembly and castor to check for free movement.</p>	<ul style="list-style-type: none"> • The equipment is not ready/available if the machine is required to be air transported and a castor wheel assembly is missing or the wheels or castor's stick, bind or do not turn freely.

APPENDIX B
Components of End Item (COEI)

GENERAL

This listing is for information purposes only, and is not authority to requisition replacements. These items are part of the DEUCE. As part of the end item, these items must be with the end item whenever it is issued or transferred between property accounts. Items of COEI are transferred between property accounts. Items of COEI are removed and separately packaged for transportation or shipment only when necessary. Illustrations are furnished to help you find and identify the items.

EXPLANATION OF COLUMNS

The following items are a description of the columns in the COEI table.

- (1) **Illust No.** - This column gives the number of the item illustrated.
- (2) **National Stock Number** - This column identifies the stock number of the item to be used for requisitioning purposes.
- (3) **Description CAGEC and Part Number** - This column identifies the Federal item name (in all capital letters) followed by a minimum description when needed. The last line below the description is the commercial and Government Entity Code (CAGEC) (in parenthesis) and the part number.
- (4) **U/M** - This column indicates how the item is issued for the National Stock Number shown in column two.
- (5) **Qty Rqd** - This column indicates the quantity required.

COMPONENTS OF END ITEM

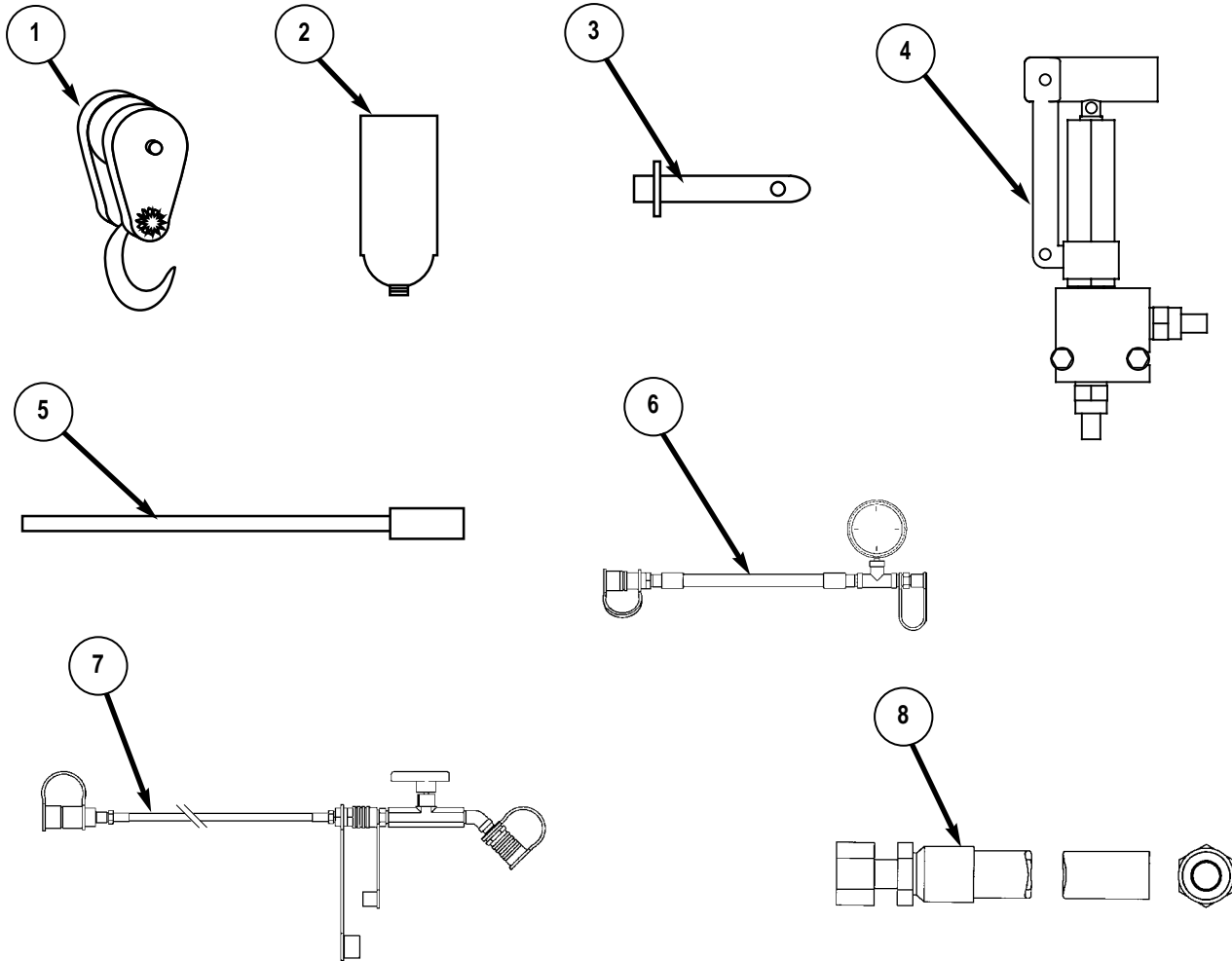

(1) Illust No.	(2) National Stock Number	(3) Description CAGEC and Part Number	(4) U/M	(5) Qty Rqd
1	3940-01-473-5761	DOUBLER BLOCK, WINCH (PART NUMBER 146-2671, CAGEC 11083)	EA	1
2	2910-00-646-9727	CYLINDER ASSEMBLY, ETHER (PART NUMBER 7N-0296, CAGEC 11083)	EA	1
3	5315-01-476-1388	PIN, KNEELING LOCK (PART NUMBER 144-7887, CAGEC 11083)	EA	2
4	4320-01-476-1389	HAND PUMP, HYDRAULIC (PART NUMBER 156-3436, CAGEC 11083)	EA	1
5	2590-01-476-1392	(FOR USE BY UNIT MAINTENANCE PERSONNEL ONLY) LEVER ASSEMBLY, HAND PUMP (PART NUMBER 144-7890 CAGEC 11083)	EA	1
6		LINES GROUP, GAUGE (PART NUMBER 162-8243 CAGEC 11083)	EA	1
7		LINES GROUP, COUPLER (PART NUMBER 156-3437 CAGEC 11083)	EA	1
8	4720-01-476-1391	HOSE ASSEMBLY (PART NUMBER 169-3173, CAGEC 11083)	EA	1

APPENDIX C
Basic Issue Items (BII) List

GENERAL

These essential items are required to place the DEUCE in operation, to operate it, and to do emergency repairs. Although shipped and packaged separately, BII must be with the DEUCE during operation and when it is transferred between property accounts. This list is your authority to request/requisition them for replacement, based on authorization of the end item by the TOE/MTOE. Illustrations are furnished to help you find and identify the items.

EXPLANATION OF COLUMNS

The following items are a description of the columns in the BII table.

- (1) **Illust No.** - This column gives the number of the item illustrated.
- (2) **National Stock Number** - This column identifies the stock number of the item to be used for requisitioning purposes.
- (3) **Description CAGEC and Part Number** - This column identifies the Federal item name (in all capital letters) followed by a minimum description when needed. The last line below the description is the commercial and Government Entity Code (CAGEC) (in parenthesis) and the part number.
- (4) **U/M** - This column indicates how the item is issued for the National Stock Number shown in column two.
- (5) **Qty Rqd** - This column indicates the quantity required.

BASIC ISSUE ITEMS (BII) LIST

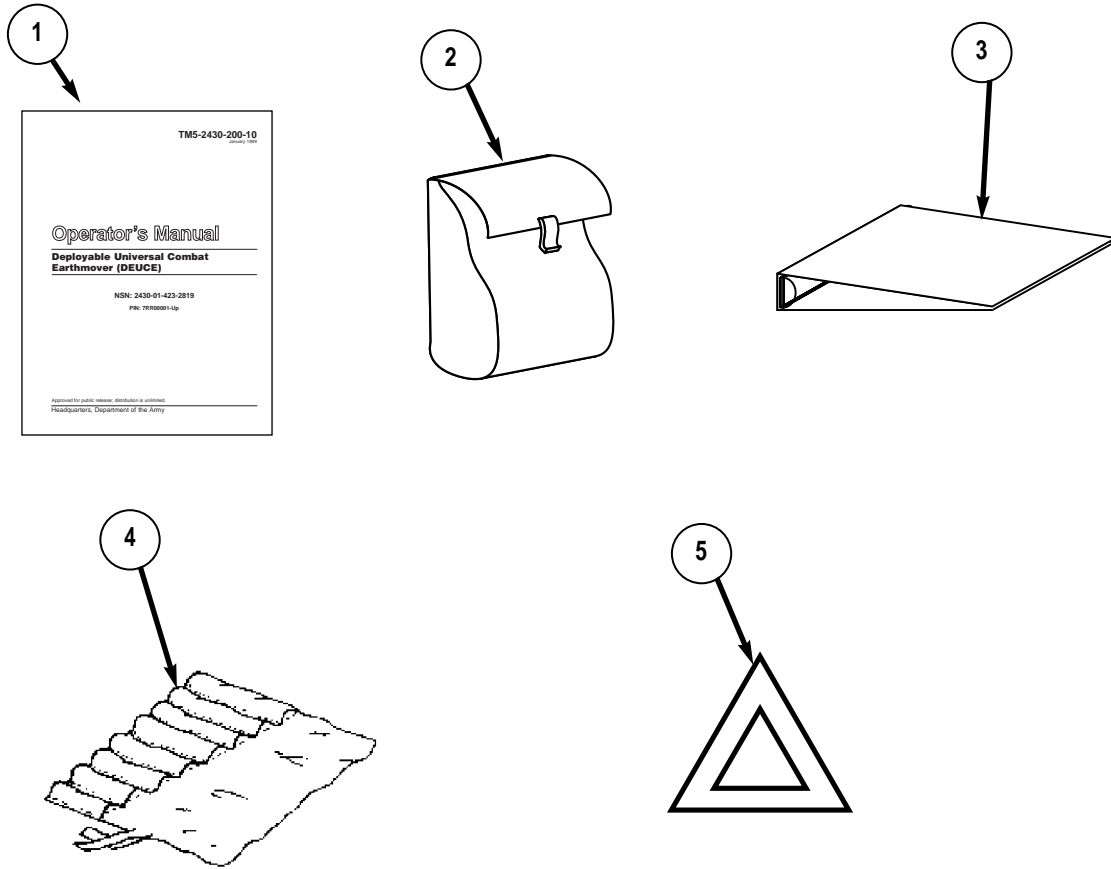

(1) Illust No.	(2) National Stock Number	(3) Description CAGEC and Part Number	(4) U/M	(5) Qty Rqd
1	TM5-2430-200-10	OPERATOR'S MANUAL	EA	1
2	2540-00-670-2459	BAG, PAMPHLET (PART NUMBER 11676920, CAGEC 19207)	EA	1
3	7510-00-281-6180	BINDER, 3-RING (PART NUMBER 0391M, CAGEC 88001)	EA	1
4	5140-00-356-8471	BAG, TOOL, SACHEL (PART NUMBER 7541507, CAGEC 19204)	EA	1
5	9905-00-148-9546	WARNING TRIANGLE (PART NUMBER 11669000, CAGEC 19207)	EA	1

BASIC ISSUE ITEMS (BII) LIST

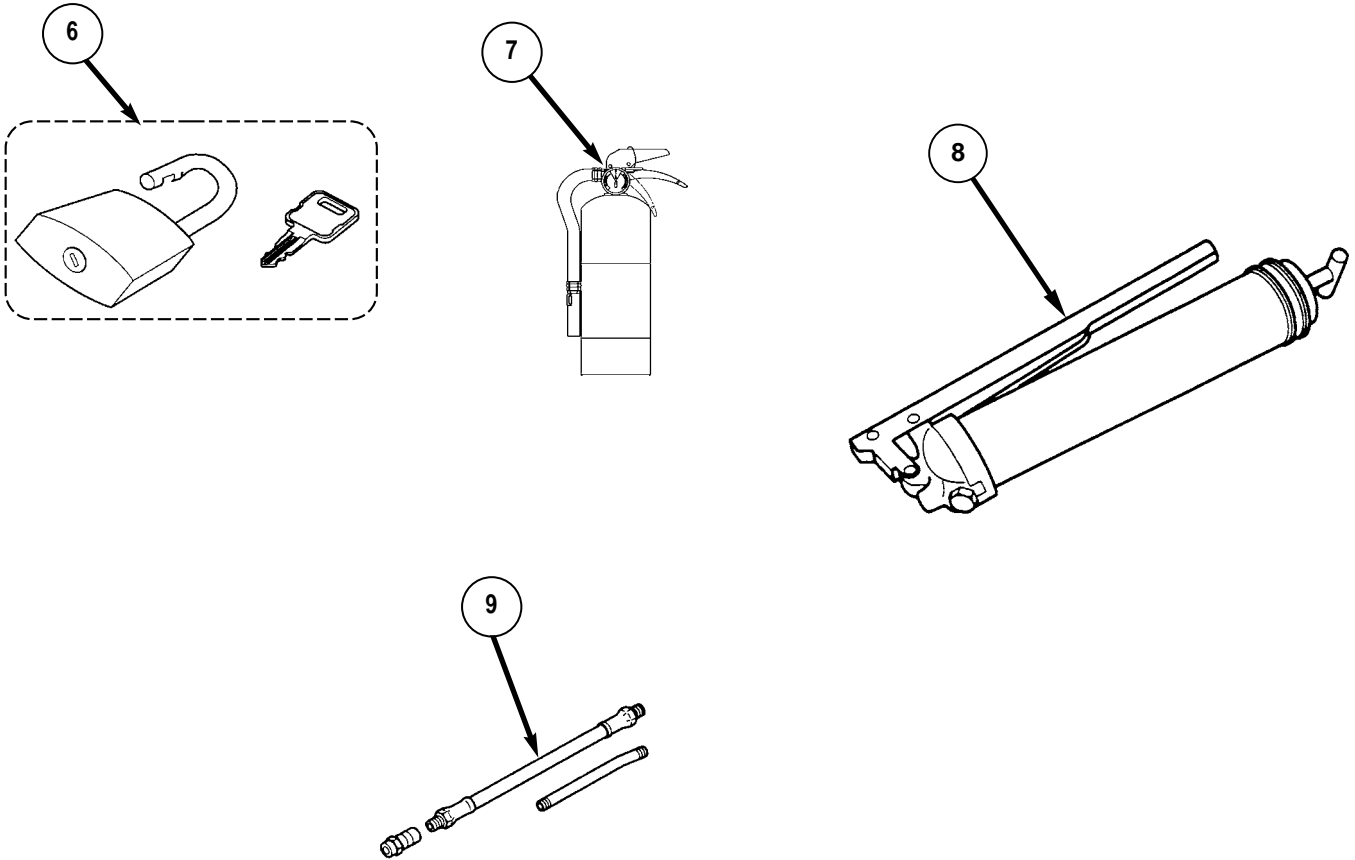

(1) Illust No.	(2) National Stock Number	(3) Description CAGEC and Part Number	(4) U/M	(5) Qty Rqd
6	5340-01-050-7059	PADLOCK SET, 5 KEYED ALIKE (PART NUMBER AA59486-1AB05S2, CAGEC 58536)	SET	1
7	4210-00-775-0127	EXTINGUISHER, FIRE (WITH BRACKET) (PART NUMBER 7015266, CAGEC 19207)	EA	1
8	4930-00-253-2478	GUN, GREASE (PART NUMBER 8F9866, CAGEC 11083)	EA	1
9	4930-00-288-1511	ADAPTER, GREASE GUN, (PART NUMBER G6, CAGEC 0AYB6)	EA	1

BASIC ISSUE ITEMS (BII) LIST

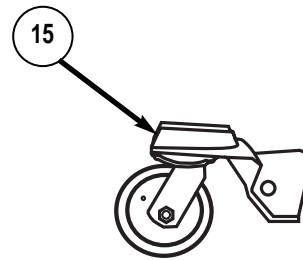
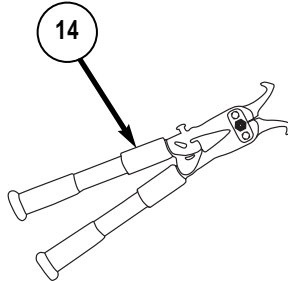
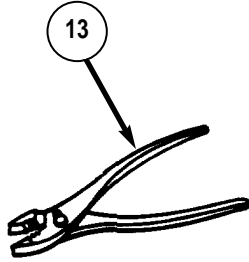
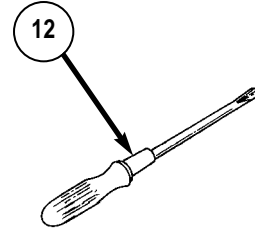
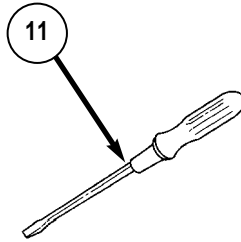
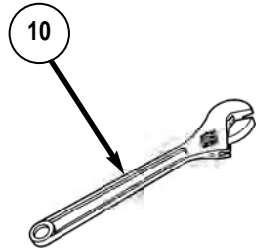

(1) Illust No.	(2) National Stock Number	(3) Description CAGEC and Part Number	(4) U/M	(5) Qty Rqd
10	5120-00-449-8083	ADJUSTABLE WRENCH, 10 INCH (PART NUMBER 1B7536, CAGEC 11083)	EA	1
11	5120-00-227-7356	SCREWDRIVER, FLAT TIP, (PART NUMBER 88213, CAGEC 57068)	EA	1
12	5120-00-234-8913	SCREWDRIVER, CROSS TIP, (PART NUMBER 546-019-001, CAGEC 59211)	EA	1
13	5120-00-223-7396	PLIERS, (PART NUMBER 276, CAGEC 93389)	EA	1
14	5110-00-541-6730	CUTTER, CABLE, HAND OPERATED, (PART NUMBER C-12, CAGEC 65196)	EA	1
15	5340-01-504-3223	CASTER ASSEMBLY, (PART NUMBER MPCU1031, CAGEC 1BEE8)	EA	2

APPENDIX D
Additional Authorization List

GENERAL

This list identifies items that do not have to accompany the DEUCE and that do not have to be turned in with it. These items are authorized to you by CTA, MTOE, TDA, or JTA.

EXPLANATION OF COLUMNS

The following items are a description of the columns in the AAL table.

- (1) **Item No.** - This column gives the number of the item.
- (2) **National Stock Number** - This column identifies the stock number of the item to be used for requisitioning purposes.
- (3) **Description CAGEC and Part Number** - This column identifies the Federal item name (in all capital letters) followed by a minimum description when needed. The last line below the description is the commercial and Government Entity Code (CAGEC) (in parenthesis) and the part number.
- (4) **U/M** - This column indicates how the item is issued for the National Stock Number shown in column two.
- (5) **Qty Rqd** - This column indicates the quantity required.

ADDITIONAL AUTHORIZATION LIST

(1) Item No.	(2) National Stock Number	(3) Description CAGEC and Part Number	(4) U/M	(5) Qty Rqd
	2910-01-486-9911	STARTING KIT—COLD WEATHER (PART NUMBER 2104713 CAGEC 11083) PART NUMBER INCLUDES ENGINE HEATER, BATTERY BOX, COMPLETE WIRING AND ELECTRICAL HOOKUPS WITH INSTRUCTION BUT DOES NOT INCLUDE BATTERIES.	EA	1
	6140-01-457-2424	BATTERY(PART NUMBER 1131CMF CAGEC 04055)	EA	1
	4720--01-461-7076	HOSE ASSY, HYDRAULIC (FROM SMALL EMPLACEMENT EXCAVATOR (SEE)(PART NUMBER FF11093 CAGEC 01276))	EA	1
		SEE TOOL KIT:		
	3820-01-242-1440	PAVEMENT BREAKER (PART NUMBER BR6713016 CAGEC 54252)	EA	1
	3820-01-161-4753	BIT CHISEL, 3 IN (PART NUMBER A43014 CAGEC 06626)	EA	1
	3820-01-160-2901	BIT MOIL POINT (PART NUMBER 02336 CAGEC 54252)	EA	1
	3820-01-242-1210	CLAY SPADE (PART NUMBER 09262M CAGEC 54252)	EA	1
	5130-01-178-6338	HAMMER DRILL (PART NUMBER 4045110 CAGEC 54252)	EA	1
	5130-01-232-8047	BIT CARBIDE 3/4 IN (PART NUMBER 05172 CAGEC 54252)	EA	1
	5130-01-061-4115	BIT CARBIDE 1 IN (PART NUMBER 02281 CAGEC 54252)	EA	1
	3820-01-232-8048	BIT CARBIDE 2 IN (PART NUMBER 02283 CAGEC 54252)	EA	1
	3695-01-243-2325	CHAIN SAW (PART NUMBER CS0662001 CAGEC 54252)	EA	1
	5130-01-300-6052	IMPACT WRENCH 3/4 IN (PART NUMBER 1W1214005 CAGEC 54252)	EA	1
	6545-00-919-6650	FIRST AID KIT (PART NUMBER UA-6882 CAGEC 64616)	EA	1
	5120-00-293-3336	SHOVEL (PART NUMBER 11655784 CAGEC 19207)	EA	1
	8415-00-634-5021	LEATHER GLOVES (PART NUMBER 37G2938 CAGEC 90142)	EA	1

Appendix E

Unit Level Transportation Information

NOTE: This appendix is for information purposes only and is not authorization for the U.S. Army Operator to maintain additional tools on the machine.

Machine Preparation for Low Velocity Air Drop (LVAD)

Start By:

- Check the undercarriage and belts for dirt and excess debris.
- Perform all "Before" and "Weekly" Preventive Maintenance and Service (PMCS) checks. Refer to "Operator Preventive Maintenance Checks and Services-DEUCE," in this manual.
- Perform unit "Quarterly" PMCS checks. Refer to "Unit Preventive Maintenance Checks and Services-DEUCE."
- Check the undercarriage balance. Refer to "Maintenance Section, Maintenance Intervals, Every 10 Service Hours or Daily, Undercarriage, Check Balance," in this manual.
- If more than one year has elapsed since the machines accumulators were charged, or if there is reason to suspect that the accumulators are not properly charged, charge the accumulators. Refer to *Specifications Systems Operation, Testing and Adjusting, Deployable Universal Combat Earthmover, (DEUCE) Undercarriage, Steering and Brakes, "Testing and Adjusting, Suspension System Procedures, Accumulator Charging Procedure."*

NOTICE

Proper charging of the suspension system accumulators is critical to a successful Low Velocity Air Drop (LVAD). The nitrogen gas in the accumulators provides the cushion necessary to prevent damage to the suspension system. Failure to properly charge the accumulators will result in significant damage to the machine during landing.

- Check the suspension hydraulic pressure. Refer to *Specifications Systems Operation, Testing and Adjusting, Deployable Universal Combat Earthmover, Undercarriage, Steering and Brakes, "Testing and Adjusting, Suspension System Procedures, Suspension Charging Procedure."*

- Check fuel level. The level indicator should read one half to three fourths of a tank. Refer to "Operation Section, Monitoring Systems and Cab Features, Indicators," in this manual.

NOTE: Park the machine on a flat, level surface to remove the top half of the cab. If the machine is not level, there is an increased chance of breaking a window during the procedure.

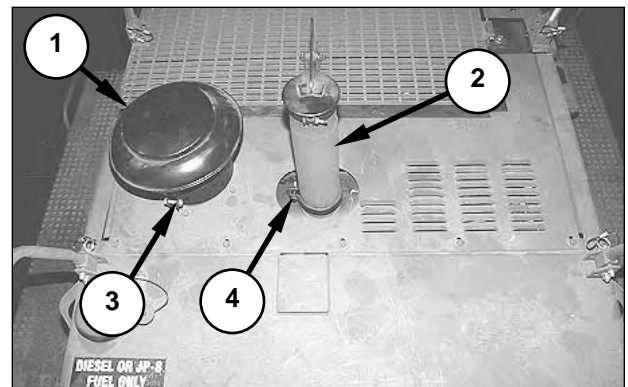

- Remove clamp (4) and muffler extension (2).
- Remove clamp (3), and precleaner hood (1).

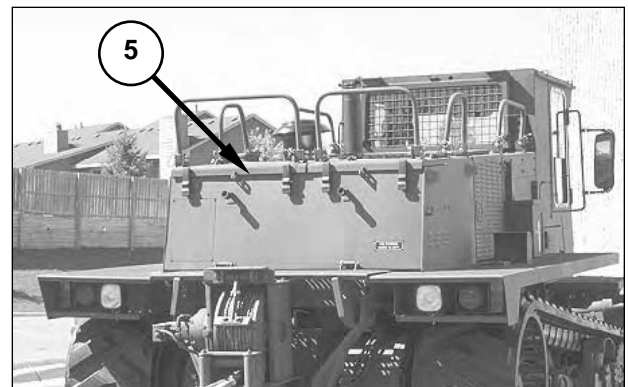

- Store the muffler extension, precleaner assembly and the associated hardware in BII compartment (5).

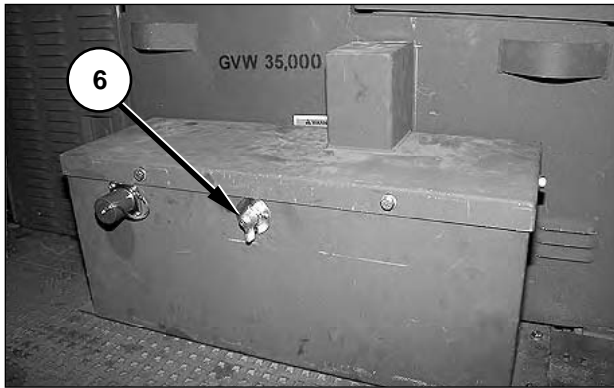
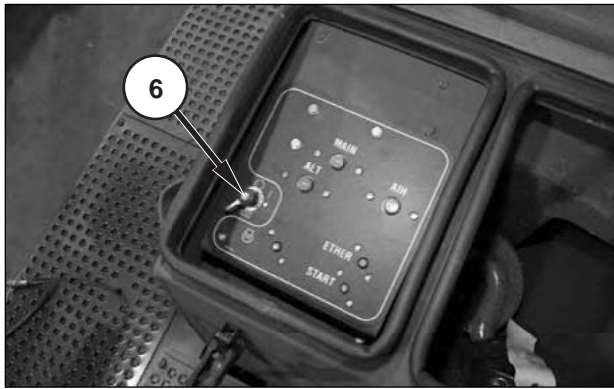

Second Main Disconnect Switch for Optional Arctic Starting System.

4. Move both main disconnect switches (6), if equipped, into the OFF position.

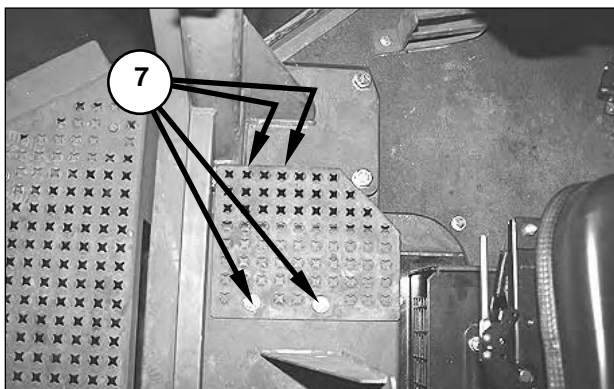

5. Remove four bolts (7) and tread the plate.

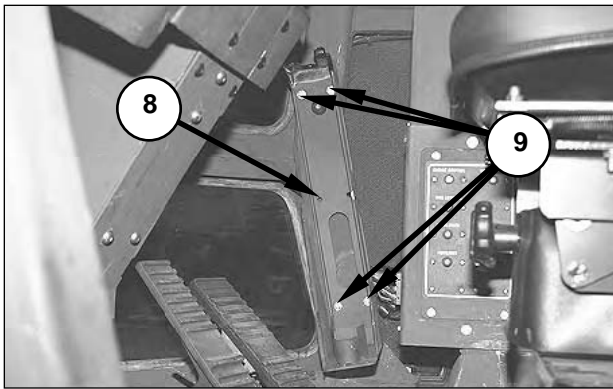

6. Remove four bolts (9) with washers, and rifle bracket (8).

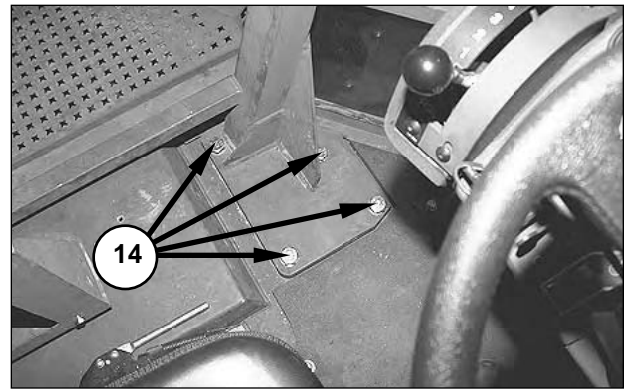

9. Remove four bolts (14) with the washers from the left front corner of the cab.

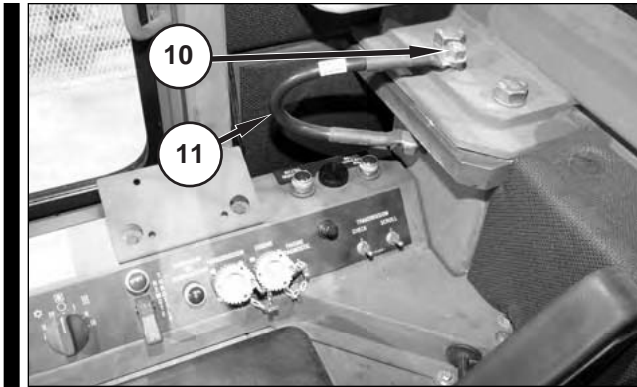

7. Remove one nut (10) with the washers, and disconnect ground cable (11) from the ground stud.

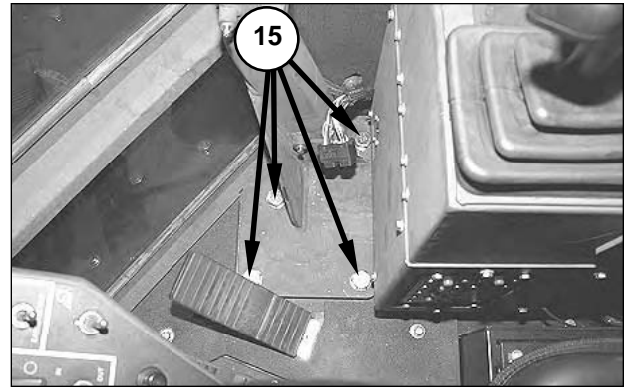

10. Remove four bolts (15) with the washers from the right front corner of the cab.

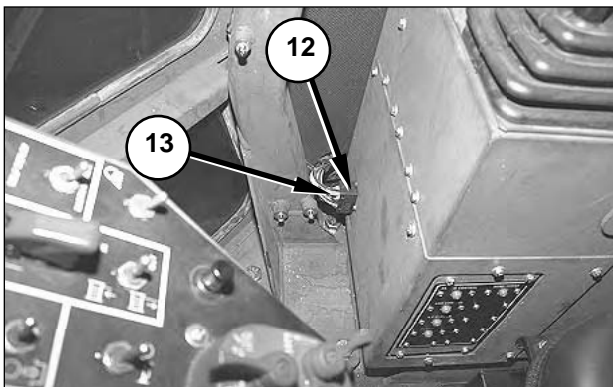

8. Loosen one screw (13), and disconnect connector (12).

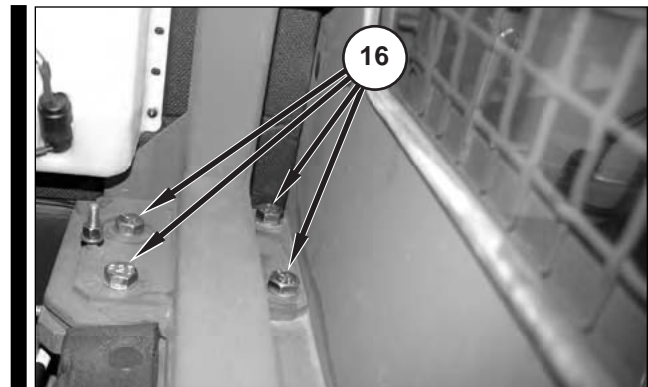

11. Remove four bolts (16) with the washers from the right rear corner of the cab.

NOTE: Screw (13) is located in the center of connector (12).

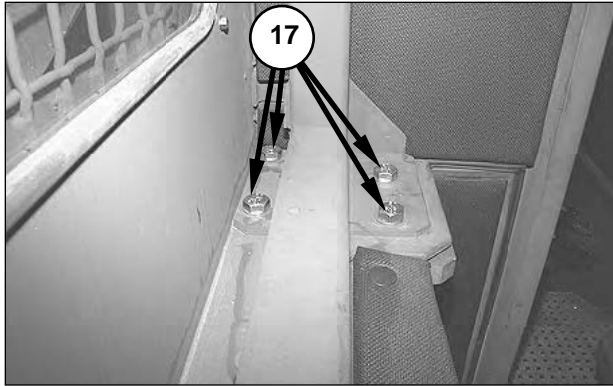

12. Remove four bolts (17) with the washers from the left rear corner of the cab.

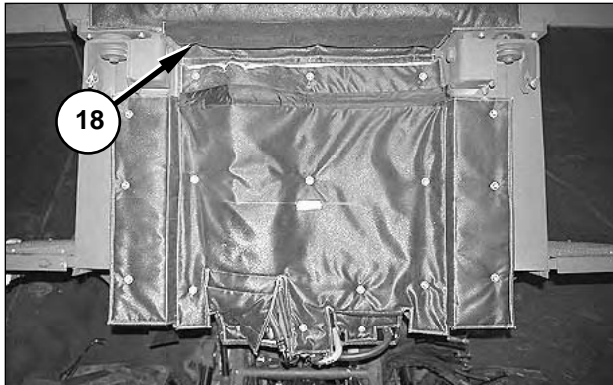

13. Detach the insulation cover on the back of the cab at seam (18).

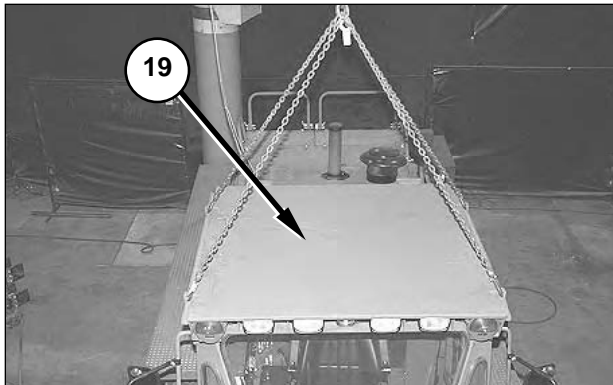

13. Attach a hoist to upper cab (19). The weight of the upper cab is approximately **431 kg (950 lb)**.

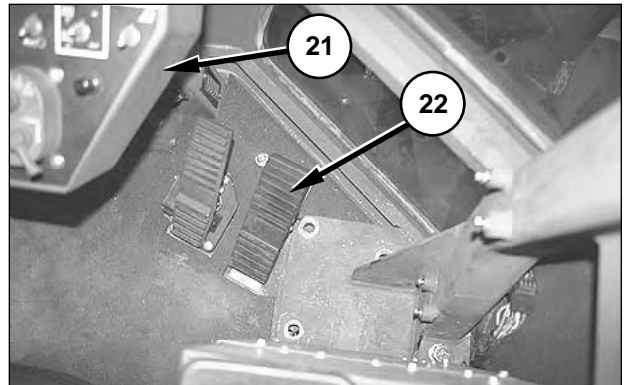
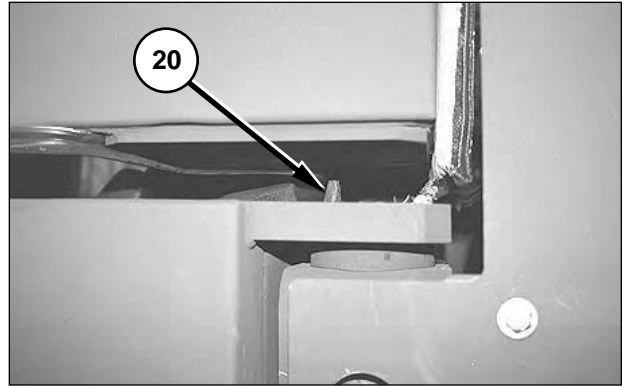

14. Lift the cab vertically for approximately 25 mm (1 in) to allow the mounting pads in the upper cab to clear guide pins (20) at the rear of the cab platform. Once the cab has cleared the guide pins, slowly move the cab forward until it has cleared accelerator pedal (22), and then remove it.

NOTE: Pay close attention when lifting the cab away from the platform. Make sure that the cab does not damage accelerator pedal (22), instrument console (21), or the back of the operator's seat.

⚠ WARNING

Improper lifting can allow the load to shift and cause injury or damage.

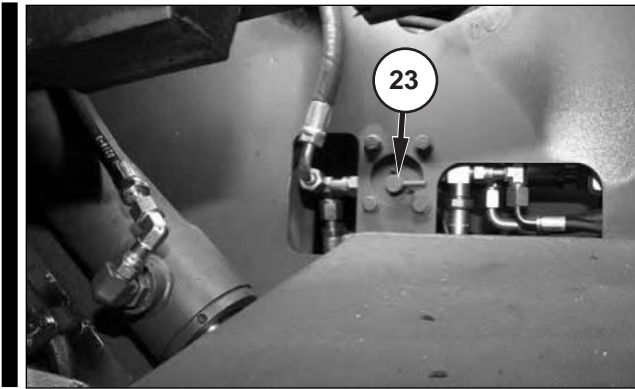

15. Verify that suspension manual lockout valve (23, on both sides of the machine) are turned fully clockwise to the OPEN position.

NOTE: Rig the DEUCE in accordance with FM 10-521 and TO 13C7-6-21

NOTE: The following procedure is for reconfiguring the machine after it has been air dropped.

NOTE: Before the cab is replaced, the integrity of the seals between the cab and the platform should be checked. Replace the seals if necessary. Reseal any areas that may leak with **4C9613 RTV Silicone-Clear**.

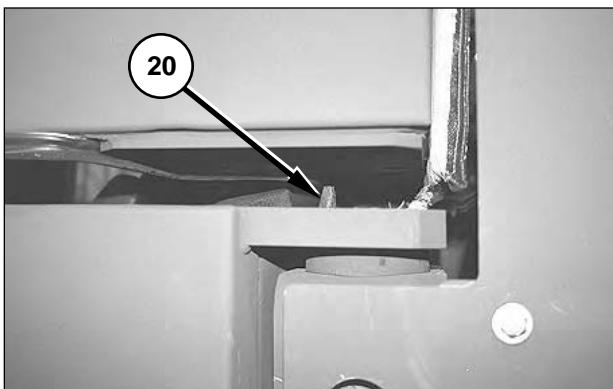

16. Lower the cab on guide pins (20) at the rear of the cab platform.

NOTE: Pay close attention when lowering the cab onto the platform. Make sure that the cab does not damage accelerator pedal (22), instrument console (21), or the back of the operator's seat.

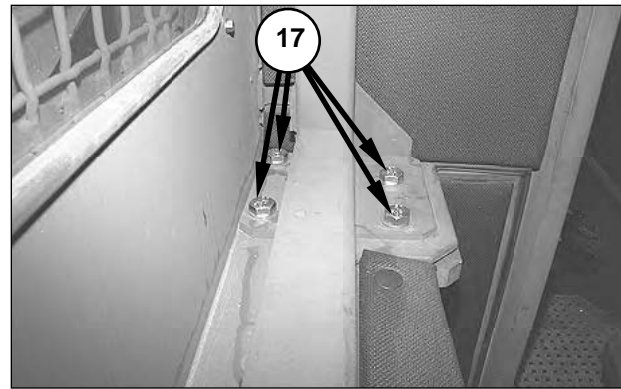

17. Install four bolts (17) with the washers in the left rear corner of the cab. Tighten the bolts to a torque of **460 ± 60 N•m (340 ± 45 lb ft)**.

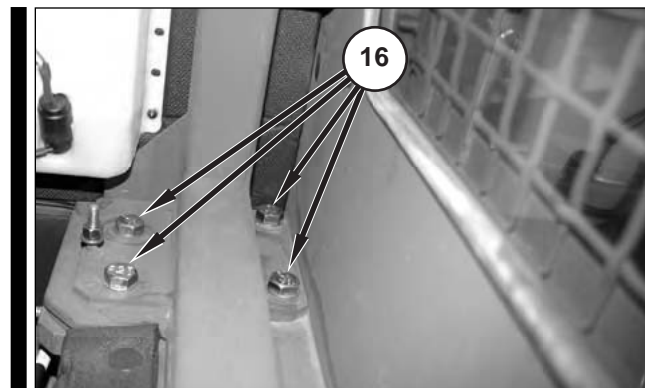

18. Install four bolts (16) with the washers in the right rear corner of the cab. Tighten the bolts to a torque of **460 ± 60 N•m (340 ± 45 lb ft)**.

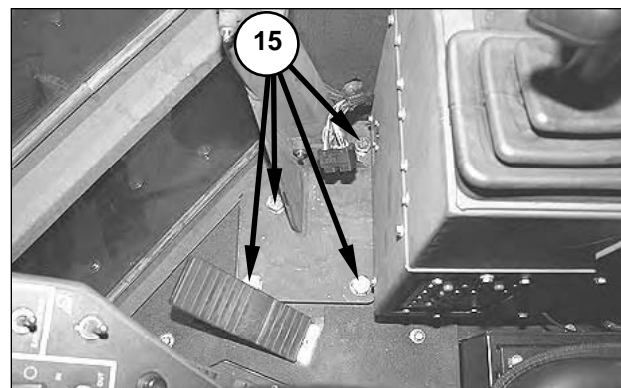

19. Install four bolts (15) with the washers in the right front corner of the cab. Tighten the bolts to a torque of **460 ± 60 N•m (340 ± 45 lb ft)**.

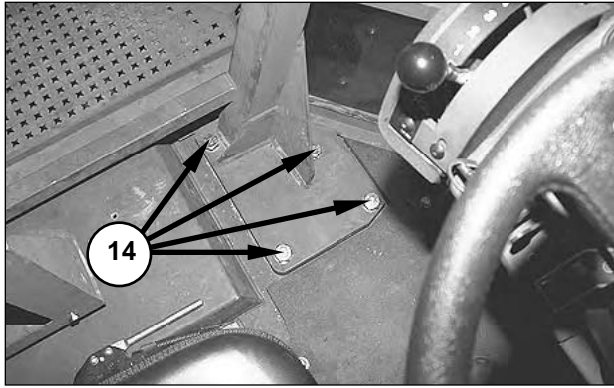

20. Install four bolts (14) with the washers in the left front corner of the cab. Tighten the bolts to a torque of $460 \pm 60 \text{ N}\cdot\text{m}$ ($340 \pm 45 \text{ lb ft}$).

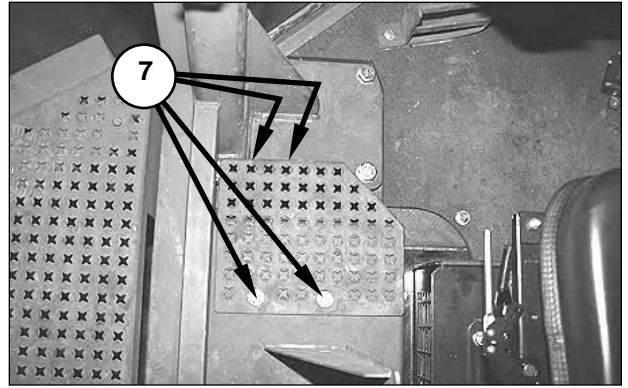

23. Install four bolts (7) with the washers, and the tread plate.

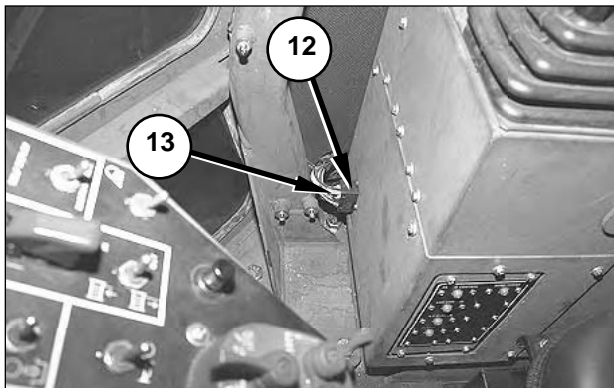

21. Connect connector (12), and tighten screw (13) to a torque of $0.9 \text{ N}\cdot\text{m}$ (8 lb in).

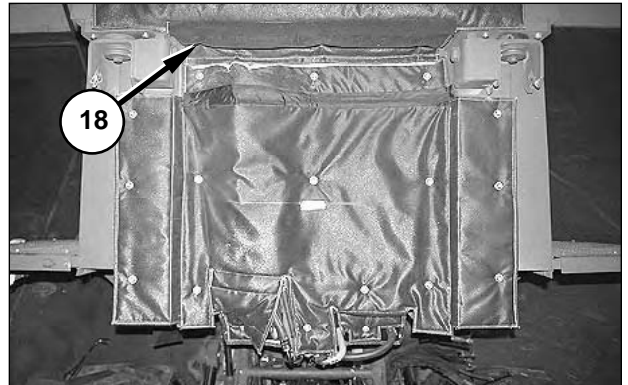

24. Attach the insulation cover on the back of the cab at seam (18).

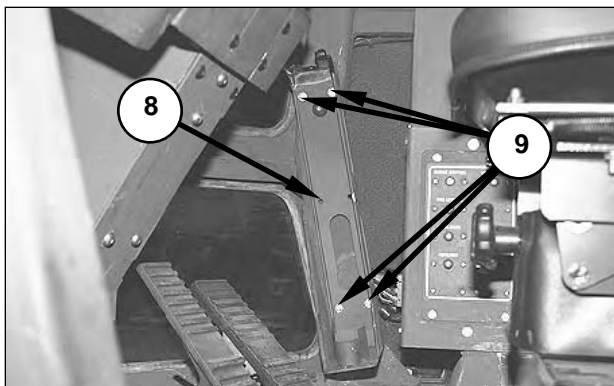

22. Install four bolts (10) with the washers, and rifle bracket (9).

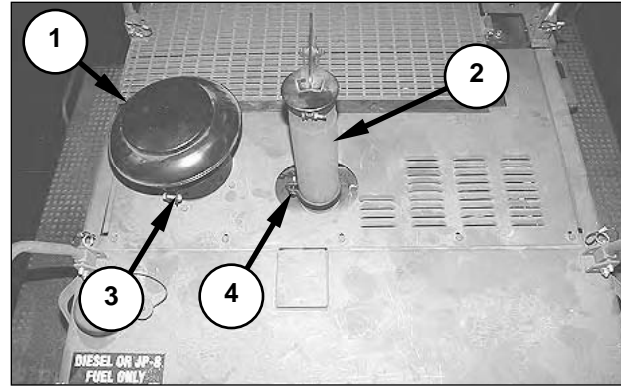
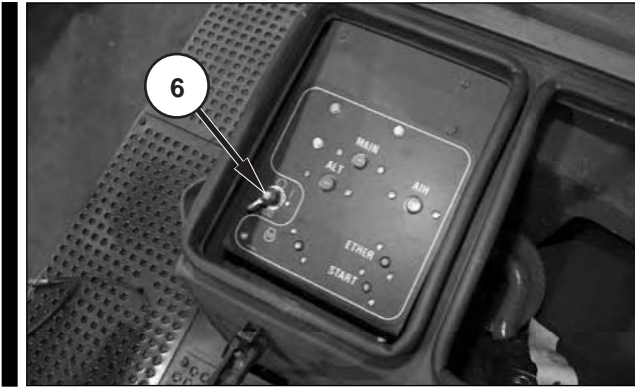

27. Install precleaner hood (1) with clamp (3).

28. Install muffler extension (2) with clamp (4). Make sure to install muffler extension (2) with the rain cap hinge facing towards the front of the machine, as shown.

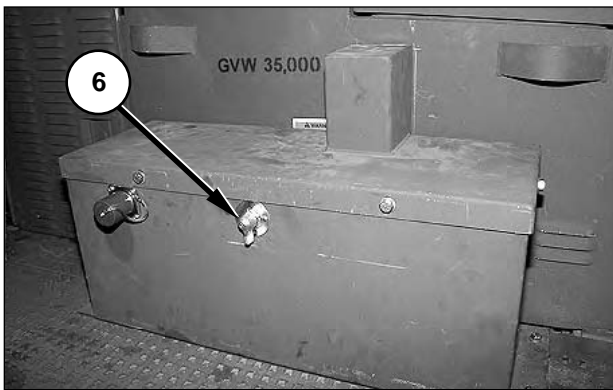

Second Main Disconnect Switch for Optional Arctic Starting System.

25. Move both main disconnect switches (6), if equipped, into the ON position.

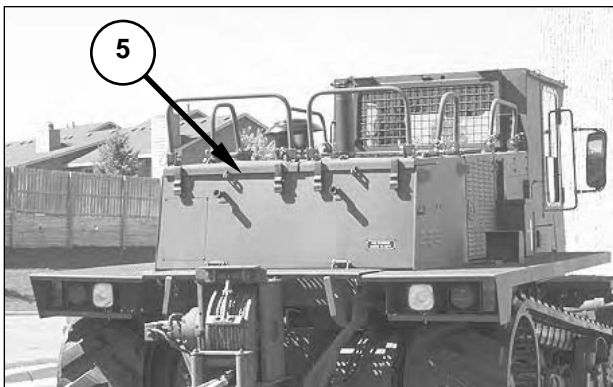

26. Retrieve the muffler extension, precleaner assembly and the associated hardware in BII compartment (5).

Preparation for Special Shipping Width

The machine should be prepared for special shipping width when it is necessary to reduce the width of the machine to 2591 mm (102 in).

NOTE: The following procedure is for reducing the shipping width of the machine by collapsing the blade. There may be other steps required to fully prepare the machine for shipping. Refer to "Operation Section, Transportation Information" in the *Operator's Manual*.

1. Drive the machine onto the transport vehicle, park the machine in position for shipping, and apply the parking brake.

NOTE: It is possible to perform this procedure while the machine is not on the transport trailer, and then drive the machine onto the transport trailer after the blade has been collapsed. However, care must be taken not to operate the blade angle function while the blade is collapsed, to avoid damaging the angle cylinders.

2. Angle the blade fully in the desired direction, and put the blade in position 25 mm (1.0 in) off the deck of the transport vehicle.

NOTE: The blade must be off the deck of the transport machine to allow manual positioning of the blade after the angle cylinders are disconnected.

3. Stop the engine. Refer to "Operation Section, Machine Parking, Engine Stopping," in the *Operator's Manual*.

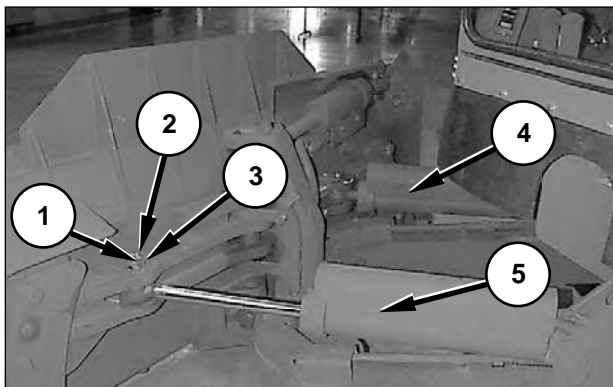

4. Remove bolt (2), pin retainer (3), and pin (1) from retracted angle cylinder (4) and extended angle cylinder (5). Put the pins, bolts and retainers in a location where they will not be lost during transport.

NOTE: It may be necessary to drive pin (1) in the right angle cylinder down in order to remove the pin.

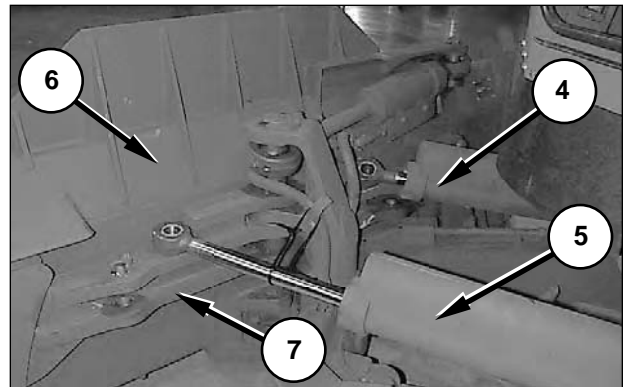

5. Slide angle cylinders (4) and (5) with the spacers out of single tree (7). Collect the spacers, and place them in a location where they will not get lost during transport.

6. Rotate blade (6) by hand until the blade stops against the singletree.

7. Slowly move the blade control lever into the down position to allow the blade to rest on the transport vehicle deck.

NOTE: It is not necessary to start the machine to lower the blade. The blade will lower under its own weight when the blade control valve is moved into LOWER. If the start switch is in the ON position, the machine must be in EARTHMOVING mode to lower the blade.

8. Secure the blade in the fully angled position to ensure that it does not move during transport.

9. Secure angle cylinders (4) and (5) to keep the rod eyes from moving during transport. Make sure that the chrome portion of the cylinders will not come into contact with any hard surfaces during transport.

NOTICE

Do not wrap metal chains or other metallic retainers around the chrome portion of the angle cylinders. Damage to the chrome surfaces will cause the cylinders to leak and allow dirt into the hydraulic system.

10. Cover the exposed chrome portion of the cylinders in a suitable material to protect the chrome from damage during shipment.

NOTE: The following steps are for returning the blade to normal service after the blade has been prepared for special shipping width.

11. Remove all of the tie-down fasteners and protective coverings from the blade and the angle cylinders.
12. Start the engine. Refer to "Operation Section, Engine Starting" in the *Operator's Manual*.
13. Raise the blade until it is approximately 25 mm (1 in) above the transport vehicle deck.

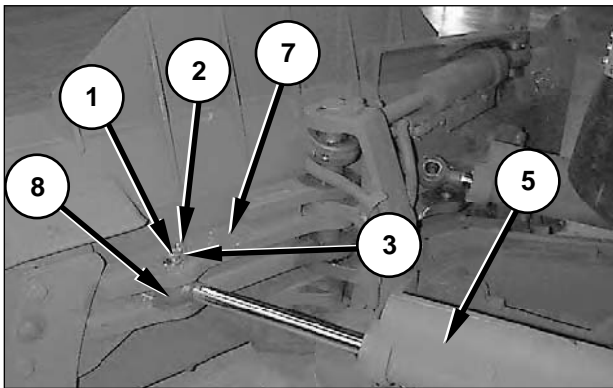

14. Move rod eye (8), of extended angle cylinder (5) into position in singletree (7). Rotate the blade by hand to achieve correct alignment between the holes in the singletree and the hole in the rod eye.
15. Install one spacer above and below the rod eye to remove the vertical gap between the rod eye and the singletree.
16. Install pin (1), retainer (3), and bolt (2).
17. Lower the blade to the ground, and apply slight downward pressure to the blade to keep it from rotating.

NOTE: The machine must be in EARTHMOVING mode to lower the blade when the start switch is in the ON position.

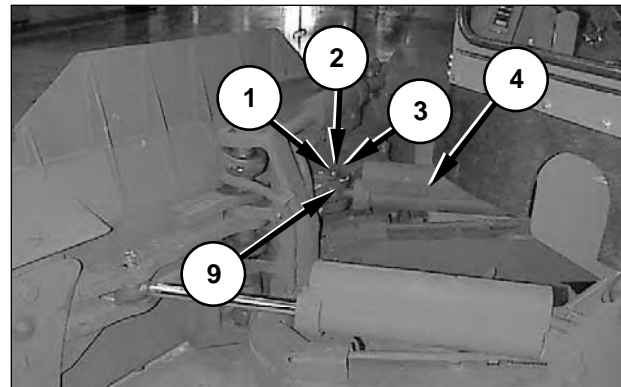

18. Put rod eye (9) of retracted angle cylinder (4) into position in singletree (7).
19. Operate the blade angle function to extend or retract the rod eye of retracted angle cylinder (4) until the rod eye is aligned with the hole for the pin in singletree (7).
20. Install one spacer above and below the rod eye to remove the vertical gap between the rod eye and the singletree.
21. Install pin (1), retainer (3) and bolt (2).
22. The blade is now ready for normal operation.

NOTE: Be sure grease the angle cylinder pins before using the machine to do work.

Appendix F

PLGR Instructions

NOTE: For additional information about the PLGR, refer to *TM 11-5825-291-13, Operations and Maintenance Manual, Satellite Signals Navigation Sets AN/PSN-11 and AN/PSN-11(V)1*.

NOTE: This appendix is not authorization for the operator to maintain additional tools or perform maintenance tasks.

1. Move the main disconnect switch to the OFF position. Refer to "Operation Section, Maintenance Features, Main Disconnect Switch."

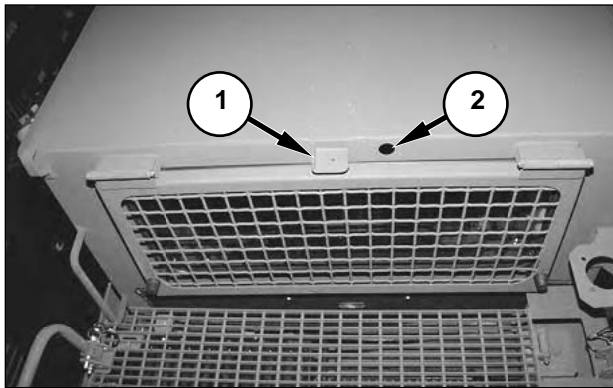

2. Remove plug (2) from the hole in the cab near antenna mounting bracket (1).
3. Install the nonmetallic grommet in hole (2).

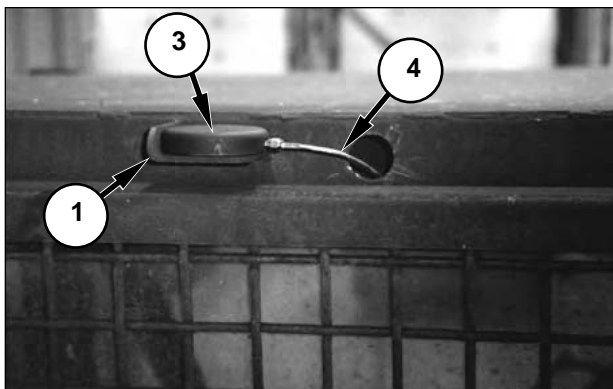

4. Use one 10-32 screw with a washer to install antenna (3) on antenna mounting bracket (1).

NOTE: The screw is installed through the bottom of mounting bracket (1).

5. From inside the cab, feed antenna wire (4) through the hole, and connect the end of the wire to antenna (3).

NOTE: Inside the cab, feed the end of antenna wire (4), which attaches to the navigation set, through the straps along the upper right side and down the right side of the cab. Use wire ties to secure the wire to the straps.

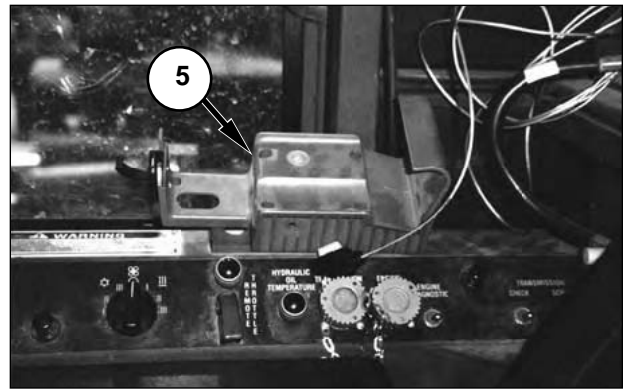

6. Use four 10-24 (16 mm [0.625 in] long) screws with two washers and one 10-24 nut per screw to install PLGR mount (5) to the mounting bracket on the right console.

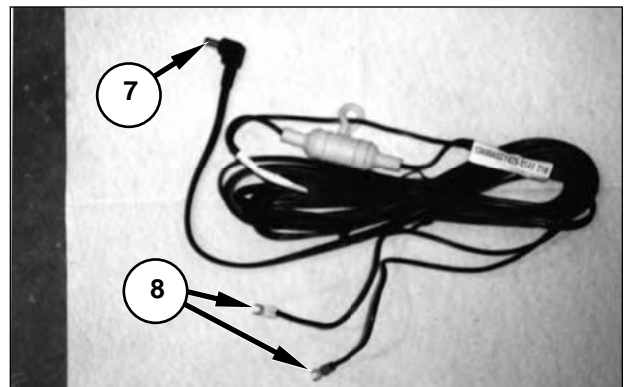
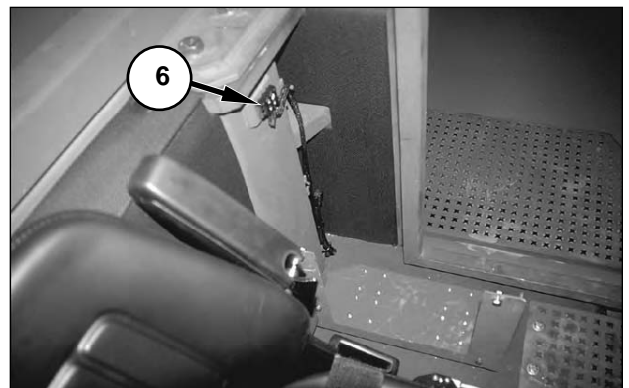

7. Connect end (8) of the power cord to power strip (6), and end (7) to the navigation set.

NOTE: Power strip (6) is 24 volts. Route the power cable through the same straps as the antenna cable. Secure any excess power cable and antenna wire with wire ties.

PLGR BILL OF MATERIAL

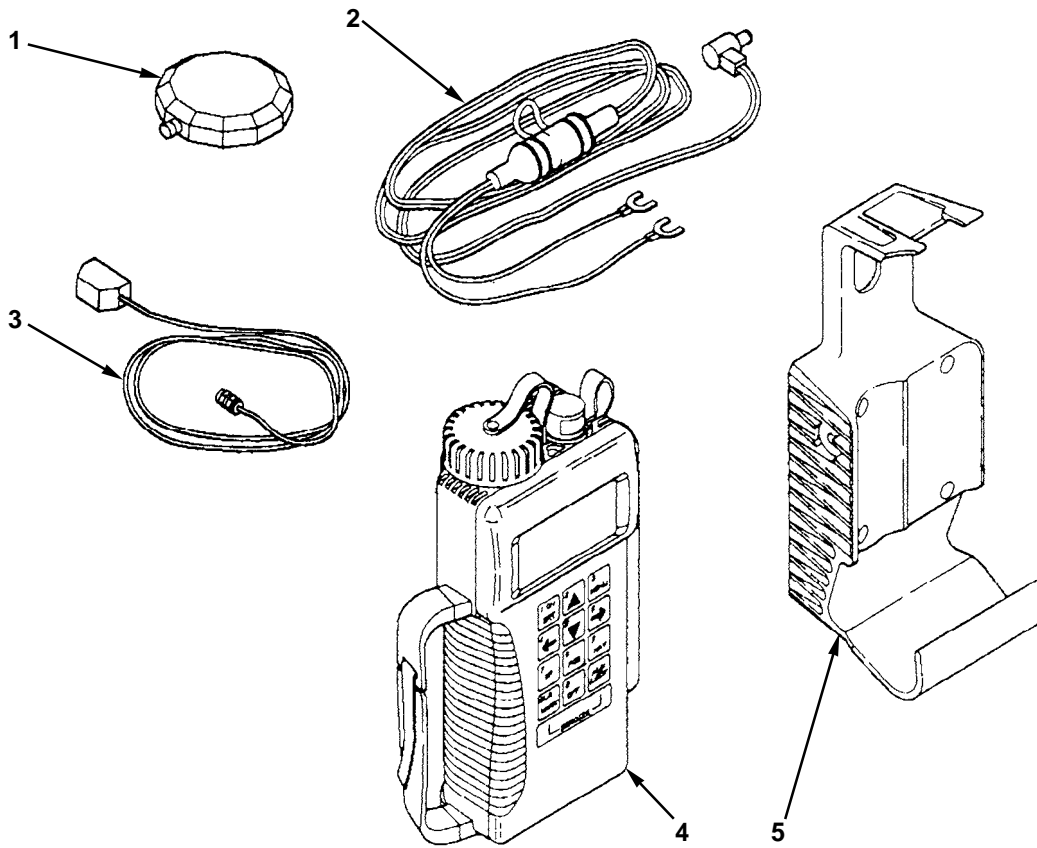

(1) Illust No.	(2) National Stock Number	(3) Description	(4) U/M	(5) Qty Rqd
1	5985-01-375-4660	ANTENNA, REMOTE AS-4333/V	EA	1
2	6150-01-375-8661	CABLE ASSEMBLY, POWER (AN/PSN-11 EXTERNAL POWER CABLE	EA	1
3	6150-01-375-8662	CABLE ASSEMBLY, SPECIAL (AS/PSN-11 TO REMOTE ANTENNA CABLE	EA	1
4	5825-01-374-6643	NAVIGATION SET, SATELLITE SIGNALS (AN/PSN-11[V]1)	EA	1
5	5975-01-375-1302	MOUNT	EA	1
-	5305-00-576-7521	10-32X3/8 SLOTTED PAN HEAD MACHINE SCREW (PART NUMBER MS35224-61)	EA	1
-	5305-00-043-6733	10-24X5/8 SLOTTED PAN HEAD MACHINE SCREW (PART NUMBER MS35225-64)	EA	4
-	5310-00-934-9758	10-24 NUT (PART NUMBER MS35649-202)	EA	4
-	5310-00-014-5850	WASHER, HOLE ID 0.214 TO 0.227 IN (PART NUMBER MS27183-42)	EA	9
-	5325-00-291-9366	GROMMET, NONMETALLIC (PART NUMBER MS35489-11)	EA	1
-	5975-00-111-3208	STRAP, TIE DOWN, ELECTRICAL COMPONENTS (PART NUMBER MS3357-5-9)	EA	10

By Order of the Secretary of the Army:

Official:

JOEL B. HUDSON
*Administrative Assistant to the
Secretary of the Army*

ERIC K. SHINSEKI
*General, United States Army
Chief of Staff*

9920209

DISTRIBUTION: To be distributed in accordance with the initial distribution requirements for IDN: 256552, TM 5-2430-200-10

RECOMMENDED CHANGES TO PUBLICATIONS AND BLANK FORMS For use of this form, see AR 25-30; the proponent agency is ODISC4.						Use Part II (reverse) for Repair Parts and Special Tool Lists (RPSTL) and Supply Catalogs/Supply Manuals (SC/SM).	DATE Date you filled out this form.
TO: (Forward to proponent of publication or form) (Include ZIP Code) AMSTA-LC-LMPP / TECH PUBS, TACOM-RI 1 Rock Island Arsenal Rock Island, IL 61299-7630						FROM: (Activity and location) (Include ZIP Code) Your mailing address	
PART I – ALL PUBLICATIONS (EXCEPT RPSTL AND SC/SM) AND BLANK FORMS							
PUBLICATION/FORM NUMBER TM 5-2430-200-10						DATE 01 Mar 0`	Title Deployable Universal Combat, Earthmover (DEUCE)
ITEM NO.	PAGE NO.	PARA-GRAPH	LINE NO. *	FIGURE NO.	TABLE NO.	RECOMMENDED CHANGES AND REASON (Provide exact wording of recommended changes, if possible).	
						SAMPLE	
<i>*Reference to line numbers within the paragraph or subparagraph.</i>							
TYPED NAME, GRADE OR TITLE Your Name				TELEPHONE EXCHANGE/AUTOVON, PLUS EXTENSION		Signature Your Signature	

TO: (Forward direct to addressee listed in publication) AMSTA-LC-LMPP / TECH PUBS, TACOM-RI 1 Rock Island Arsenal Rock Island, IL 61299-7630	FROM: (Activity and location) (Include ZIP Code) Your address	DATE Date you filled out this form
--	---	--

PART II – REPAIR PARTS AND SPECIAL TOOL LISTS AND SUPPLY CATALOGS/SUPPLY MANUALS

PUBLICATION NUMBER TM 5-2430-200-10			DATE 01 Mar 01			TITLE Deployable Universal Combat Earthmover (DEUCE)		
PAGE NO.	COLM NO.	LINE NO.	NATIONAL STOCK NUMBER	REFERENCE NO.	FIGURE NO.	ITEM NO.	TOTAL NO. OF MAJOR ITEMS SUPPORTED	RECOMMENDED ACTION
SAMPLE								

PART III – REMARKS (Any general remarks or recommendations, or suggestions for improvement of publications and blank forms. Additional blank sheets may be used if more space is needed.)

TYPED NAME, GRADE OR TITLE Your Name	TELEPHONE EXCHANGE/AUTOVON, PLUS EXTENSION	SIGNATURE Your Signature
---	--	-----------------------------

<p>RECOMMENDED CHANGES TO PUBLICATIONS AND BLANK FORMS</p> <p>For use of this form, see AR 25-30; the proponent agency is ODISC4.</p>	<p>Use Part II (reverse) for Repair Parts and Special Tool Lists (RPSTL) and Supply Catalogs/Supply Manuals (SC/SM).</p>	<p>DATE</p>
--	--	-------------

<p>TO: (Forward to proponent of publication or form)(Include ZIP Code)</p> <p>AMSTA-LC-LMPP / TECH PUBS, TACOM-RI 1 Rock Island Arsenal Rock Island, IL 61299-7630</p>	<p>FROM: (Activity and location) (Include ZIP Code)</p>
--	---

PART I – ALL PUBLICATIONS (EXCEPT RPSTL AND SC/SM) AND BLANK FORMS

<p>PUBLICATION/FORM NUMBER</p> <p>TM 5-2430-200-10</p>	<p>DATE</p> <p>01 Mar 01</p>	<p>TITLE Deployable Universal Combat Earthmover (LDEUCE)</p>
--	------------------------------	--

ITEM NO.	PAGE NO.	PARA-GRAPH	LINE NO. *	FIGURE NO.	TABLE NO.	RECOMMENDED CHANGES AND REASON (Provide exact wording of recommended changes, if possible).

<p>TYPED NAME, GRADE OR TITLE</p>	<p><i>*Reference to line numbers within the paragraph or subparagraph.</i></p> <p>TELEPHONE EXCHANGE/AUTOVON, PLUS EXTENSION</p>	<p>SIGNATURE</p>
-----------------------------------	--	------------------

TO: (Forward direct to addressee listed in publication) AMSTA-LC-LMPP / TECH PUBS, TACOM-RI 1 Rock Island Arsenal Rock Island, IL 61299-7630	FROM: (Activity and location) (Include ZIP Code)	DATE
--	---	-------------

PART II – REPAIR PARTS AND SPECIAL TOOL LISTS AND SUPPLY CATALOGS/SUPPLY MANUALS

PUBLICATION NUMBER TM 5-2430-200-10					DATE 01 Mar 01		TITLE Deployable Universal Combat Earthmover (DEUCE)	
PAGE NO.	COLM NO.	LINE NO.	NATIONAL STOCK NUMBER	REFERENCE NO.	FIGURE NO.	ITEM NO.	TOTAL NO. OF MAJOR ITEMS SUPPORTED	RECOMMENDED ACTION

PART III – REMARKS (Any general remarks or recommendations, or suggestions for improvement of publications and blank forms. Additional blank sheets may be used if more space is needed.)

TYPED NAME, GRADE OR TITLE	TELEPHONE EXCHANGE/AUTOVON, PLUS EXTENSION	SIGNATURE
----------------------------	--	-----------

RECOMMENDED CHANGES TO PUBLICATIONS AND BLANK FORMS						Use Part II (reverse) for Repair Parts and Special Tool Lists (RPSTL) and Supply Catalogs/Supply Manuals (SC/SM).	DATE
For use of this form, see AR 25-30; the proponent agency is ODISC4.							
TO: (Forward to proponent of publication or form) (Include ZIP Code) AMSTA-LC-LMPP / TECH PUBS, TACOM-RI 1 Rock Island Arsenal Rock Island, IL 61299-7630						FROM: (Activity and location) (Include ZIP Code)	
PUBLICATION/FORM NUMBER TM 5-2430-200-10						DATE 01 Mar 01	TITLE Deployable Universal Combat Earthmover (DEUCE)
ITEM NO.	PAGE NO.	PARA-GRAPH	LINE NO. *	FIGURE NO.	TABLE NO.	RECOMMENDED CHANGES AND REASON (Provide exact wording of recommended changes, if possible).	
<i>*Reference to line numbers within the paragraph or subparagraph.</i>							
TYPED NAME, GRADE OR TITLE				TELEPHONE EXCHANGE/AUTOVON, PLUS EXTENSION		SIGNATURE	

TO: (Forward direct to addressee listed in publication) AMSTA-LC-LMPP / TECH PUBS, TACOM-RI 1 Rock Island Arsenal Rock Island, IL 61299-7630	FROM: (Activity and location) (Include ZIP Code)	DATE
--	---	-------------

PART II – REPAIR PARTS AND SPECIAL TOOL LISTS AND SUPPLY CATALOGS/SUPPLY MANUALS

PUBLICATION NUMBER TM 5-2430-200-10				DATE 01 Mar 01			TITLE Deployable Universal Combat Eathmover (DEUCE)	
PAGE NO.	COLM NO.	LINE NO.	NATIONAL STOCK NUMBER	REFERENCE NO.	FIGURE NO.	ITEM NO.	TOTAL NO. OF MAJOR ITEMS SUPPORTED	RECOMMENDED ACTION

PART III – REMARKS *(Any general remarks or recommendations, or suggestions for improvement of publications and blank forms. Additional blank sheets may be used if more space is needed.)*

--

TYPED NAME, GRADE OR TITLE	TELEPHONE EXCHANGE/AUTOVON, PLUS EXTENSION	SIGNATURE
----------------------------	--	-----------

THE METRIC SYSTEM AND EQUIVALENTS

LINEAR MEASURE

1 Centimeter = 10 Millimeters = 0.01 Meters = 0.3937 Inches
 1 Meter = 100 Centimeters = 1000 Millimeters = 39.37 Inches
 1 Kilometer = 1000 Meters = 0.621 Miles

SQUARE MEASURE

1 Sq Centimeter = 100 Sq Millimeters = 0.155 Sq Inches
 1 Sq Meter = 10,000 Sq Centimeters = 10.76 Sq Feet
 1 Sq Kilometer = 1,000,000 Sq Meters = 0.386 Sq Miles

WEIGHTS

1 Gram = 0.001 Kilograms = 1000 Milligrams = 0.035 Ounces
 1 Kilogram = 1000 Grams = 2.2 Lb
 1 Metric Ton = 1000 Kilograms = 1 Megagram = 1.1 Short Tons

CUBIC MEASURE

1 Cu Centimeter = 1000 Cu Millimeters = 0.06 Cu Inches
 1 Cu Meter = 1,000,000 Cu Centimeters = 35.31 Cu Feet

LIQUID MEASURE

1 Milliliter = 0.001 Liters = 0.0338 Fluid Ounces
 1 Liter = 1000 Milliliters = 33.82 Fluid Ounces

TEMPERATURE

$5/9 (°F - 32) = °C$
 212° Fahrenheit is equivalent to 100° Celsius
 90° Fahrenheit is equivalent to 32.2° Celsius
 32° Fahrenheit is equivalent to 0° Celsius
 $9/5 C° + 32 = F°$

APPROXIMATE CONVERSION FACTORS

<u>TO CHANGE</u>	<u>TO</u>	<u>MULTIPLY BY</u>
Inches	Centimeters	2.540
Feet	Meters	0.305
Yards	Meters	0.914
Miles	Kilometers	1.609
Square Inches	Square Centimeters	6.451
Square Feet	Square Meters	0.093
Square Yards	Square Meters	0.836
Square Miles	Square Kilometers	2.590
Acres	Square Hectometers	0.405
Cubic Feet	Cubic Meters	0.028
Cubic Yards	Cubic Meters	0.765
Fluid Ounces	Milliliters	29.573
Pints	Liters	0.473
Quarts	Liters	0.946
Gallons	Liters	3.785
Ounces	Grams	28.349
Pounds	Kilograms	0.454
Short Tons	Metric Tons	0.907
Pound-Feet	Newton-Meters	1.356
Pounds per Square Inch	Kilopascals	6.895
Miles per Gallon	Kilometers per Liter	0.425
Miles per Hour	Kilometers per Hour	1.609

<u>TO CHANGE</u>	<u>TO</u>	<u>MULTIPLY BY</u>
Centimeters	Inches	0.394
Meters	Feet	3.280
Meters	Yards	1.094
Kilometers	Miles	0.621
Square Centimeters	Square Inches	0.155
Square Meters	Square Feet	10.764
Square Meters	Square Yards	1.196
Square Kilometers	Square Miles	0.386
Square Hectometers	Acres	2.471
Cubic Meters	Cubic Feet	35.315
Cubic Meters	Cubic Yards	1.308
Milliliters	Fluid Ounces	0.034
Liters	Pints	2.113
Liters	Quarts	1.057
Liters	Gallons	0.264
Grams	Ounces	0.035
Kilograms	Pounds	2.205
Metric Tons	Short Tons	1.102
Newton-Meters	Pound-Feet	0.738
Kilopascals	Pounds per Square Inch	0.145
Kilometers per Liter	Miles per Gallon	2.354
Kilometers per Hour	Miles per Hour	0.621

